

The Electrical Experimenter

POPULAR ELECTRICAL NEWS ILLUSTRATED

ELECTRIC TORPEDO DESTROYER

SEE PAGE 10

R Langdon





Brandes "Superior" Head Set
Complete with head band \$5.50. A professional set, within the means of every amateur. 2000 ohms.

"SIGNALS vs. NOISES"



Brandes "Transatlantic" Head Set
Complete with head band, \$10. A set for general professional long distance use. 2800 ohms.

"BRANDES receivers bring in weak signals," writes an enthusiastic user, "where other phones bring in weak noises."

The reason? Brandes Matched Tone. Two diaphragms, toned at exactly the same vibration, pick wireless "whispers" out of the air and bring them clear and readable into your ear.

ORDER NOW WITHOUT RISK

Try them out. If you are not pleased in every way, we guarantee to refund your money. Catalog E, which tells the whole Brandes story, sent you for 4c. in stamps.

C. BRANDES, Inc., Wireless Receiver Specialists, Room 814, 32 Union Square, New York, N. Y.

Brandes Wireless Receivers

"The Receivers With Matched Tone"

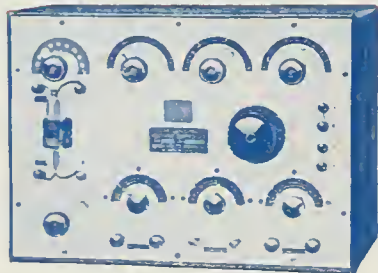

Mignon Undamped Wave

WIRELESS APPARATUS

Amateur and Commercial Use

This latest Mignon invention is entering a new field in Radio engineering, eliminating the so familiar LOOSE COUPLERS and LOADING COILS, and introduces adjustable DISC-CORES, heretofore considered impossible.

DISTANCE RANGE UNLIMITED

"Complete Equipment for all Purposes." Represented in all Principal Foreign Countries

MIGNON WIRELESS CORPORATION

ELMIRA, N. Y., U. S. A.

Write for Catalogue and mention Electrical Experimenter





EXACT SIZE OF CYCLOPEDIA No. 18

FREE

Yes, entirely free. Our big, new electrical encyclopedia No. 18 is waiting for you. Positively the most complete wireless and electrical catalog in print today. 200 Big Pages, 600 Illustrations, 500 Instruments and apparatus, etc. New Art Section contains finest Radio Outfits made. Big "Treatise on Wireless Telegraphy." 20 FREE coupons for your 100-page FREE Wireless Course in 20 lessons. FREE Encyclopedia No. 18 measures 7x5 1/4". Weight 1 1/2 lb. Beautiful stiff covers.

"THE LIVEST CATALOG IN AMERICA"

Now before you turn this page write your name and address on margin below, cut or tear out, margin ONLY, paste on postal card and the Encyclopedia is yours by return mail.

THE ELECTRO IMPORTING CO., 231 Fulton St., N. Y. C.



You benefit by mentioning "The Electrical Experimenter" when writing to advertisers.

LEARN ELECTRICITY AT HOME



FREE! 20 COMPLETE LESSONS



Write me at once—TODAY! Just send the coupon or a postal. I will give you 20 complete lessons in practical electricity FREE! Think of it! My personal and individual instruction for 20 lessons without a cent of cost to you if you act quick. No charge to you for these 20 lessons now or later. I make this sensational offer to secure a few more live students—to show, too, how quickly I can make you a Master Electrician no matter where you live, or what you do. But you must act at once! This offer closes in 23 days! Remember these free lessons are not merely sample lessons, but are a regular part of my full and complete course in electricity. Send the coupon without delay—TODAY!

Earn \$2,500 to \$4,000 a Year

You can now qualify at home during your spare time, and without giving up your present position or occupation, for that most wonderful of all fields open to the ambitious man—the great and growing field of Electricity! Yes, no matter if you don't know a thing about electricity or never had a bit of electrical experience, I will take you in hand and make you an Expert Electrician so that you should easily earn \$2,500 to \$4,000 a year and more. And I'll do it so quickly and with so little effort on your part, that you'll wonder how it was possible. No books or tools to buy.

I Train You By Mail! Men Wanted

I will instruct you personally—make the whole matter so simple for you that you can't help but learn. When you have finished my instructions you are an Expert Electrician—ready to take a big paying job or start in for yourself. I show you not only how to do practical electrical work, but how to estimate on jobs so that you can take contracts at big profits. That's what it means to be trained by a man of my practical experience.

Wherever you go there's always urgent demand for Expert Electricians and at big pay. That's because the watchword of the age is, "DO IT ELECTRICALLY." The field of electricity is broadening so fast that there's a big shortage of competent electricians. And the demand is increasing every day.

A. W. WICKS, E. E.
Formerly with the General Electric Co.; former General Manager of company manufacturing Kenney Electric Motors; also formerly with Fairbanks, Morse & Co.; now Consulting Engineer and Director of the Wicks Electrical Institute.

Mail Coupon Today

A. W. WICKS, E. E., Director, Wicks Electrical Institute
81 W. Randolph St. Dept. 295 Chicago, Ill.

Without any obligation to me whatever, please send me full description of your personal instructions in Electricity and particulars of your special offer of 20 of your lessons free.

Name.....
Street and No.....
City..... State.....

YOU MUST ACT QUICK

Mail coupon today. I want to hear from you immediately. Don't miss my offer of 20 personal lessons free. Remember this offer is strictly limited to 23 days. Write for all particulars at once. Here's your chance! No obligation to you. Send coupon or postal NOW!

A. W. WICKS, E. E., Director
Wicks Electrical Institute
81 W. Randolph St., Dept. 295 Chicago, Ill.

You benefit by mentioning "The Electrical Experimenter" when writing to advertisers.

The Electrical Experimenter

233 Fulton Street, New York.

Published by Experimenter Publishing Company, Inc. (H. Gernsback, President; S. Gernsback, Treasurer;) 233 Fulton Street, New York

Vol. V Whole No. 49

CONTENTS FOR MAY, 1917

No. 1

ELECTRIC TORPEDO DESTROYER—Front Cover.....	
From a painting by George Wall	
A ONE-MAN ELECTRIC SUBMARINE.....By H. Winfield Secor	5
ELECTRIFYING THE AEROPLANE.....	7
THE AUTOGRAPH OF YOUR HEART.....By Samuel Cohen	8
COMBATING THE SUBMARINE.....By H. Gernsback	10
SOURCES OF ELECTRICITY.....	12
MAGNETISM PRODUCES REMARKABLE PHOTOGRAPHS.....	14
By F. F. Mace	
THE THERAPY OF LIGHT AND THE NEW "R-RAY".....	15
By H. Rosenthal	
"EDDY CURRENTS"—A Scientific Story.....By C. M. Adams	20
THE WASHINGTON'S BIRTHDAY RELAY PRIZE WINNERS	
By W. H. Kirwan	23
ELECTRICITY AND LIFE—Second Paper.....	24
By Dr. Frederick Finch Strong	
EXPERIMENTAL PHYSICS—Fourth Lesson.....	25
By John I. Furia, A.B., M.A., F.K.S.	
WIRELESS TELEGRAPHY—THE MARCONI HIGH POWER	

TRANS-OCEANIC STATIONS.....	26
By E. B. Pillsbury, Marconi Wireless Telegraph Co.	
HOW THE AUDION REPEATER REPEATS.....	30
THE IONIC RADIO SYSTEM AND THEORY OF IONIC	
TUNING.....By Otto E. Curtis, A.M., I.R.E.	31
RECEIVING MARCONI 300 K.W. SPARK STATIONS WITH	
OSCILLATING AUDION.....	32
By Samuel Curtis, Jr., R.E., U.S. Navy	
DISTRIBUTED CAPACITY AND ITS EFFECT.....	33
By Samuel Cohen	
A STUDY OF THE LAW OF RESPONSE OF THE SILICON	
DETECTOR.....	34
CONSTRUCTOR DEPARTMENT—AN ELECTRICAL PARADOX	
OR SELECTIVE LAMP CONTROLLER.....	36
By Albert H. Beiler	
AN ILLUMINATED STAGE SULKY.....By Harry S. Townsend	38
A SIMPLE ELECTRIC MOTOR ATTACHMENT FOR PHONO-	
GRAPHS.....By R. U. Clark, 3d	40
EXPERIMENTAL CHEMISTRY—Twelfth Lesson.....	43
By Albert W. Wilsdon	

War and the Radio Amateur



THE Radio Act of 1912, under section 2 states:

Every such license shall provide that the President of the United States in time of war or public peril may cause the closing of any station for radio communication and the removal therefrom of all radio apparatus, or may authorize the use or control of any such station or apparatus by any department of the Government, upon just compensation to the owner.

We now stand on the threshold of war; indeed, before this issue is in the hands of our readers war will have been declared, or what is equivalent, this country will be in a state of war.

Let us then be perfectly frank with each other, and let us face the situation as it behooves upright, patriotic, law-abiding citizens. The European war has taught us that messages sent from secret radio plants by spies have been of priceless value to the enemy. Small wonder then that hysteric officials of all the warring nations have exterminated every possible as well as impossible private wireless plant in their respective countries. But to what good? True, every stationary outfit has been dismantled or confiscated by the warring Governments, but as always: where there's a will there's a way. When the German spies in England and in France found that it was not very healthy to operate their outfits in attics or in house chimneys—for a sending outfit is soon located—they simply put their radios in touring cars, cleverly concealing the aerial wires inside of the car bodies. The apparatus too were easily concealed, and the English and French were outwitted simply because you cannot locate a moving radio outfit except by pure chance.

Which brings us face to face with the question: Did it pay the warring nations to kill the few private Radio stations they had before the war? We are honestly inclined to believe that far from being an advantage, it proved an actual disadvantage. No one at all familiar with the technique of the radio art, doubts for one minute that if a spy has the courage as well as the funds—and spies always have both—he cannot be stopt from sending wireless messages if he elects to do so. Working under cover and by moving from one place to another, nothing will stop him.

If we recognize this truth we realize how absurd it is to close all privately owned radio stations during the war. It will do no earthly good and can do only actual harm. Now we do not wish to appear selfish, nor do we wish to be classed as unpatriotic. Very much the contrary. If the administration, after carefully considering all the facts, decides to close all privately owned radio stations in this country, we will not as much as raise a single word of protest. The administration knows what is best for the welfare of the country and in time of national peril we would be the last ones to annoy our officials.

But is it not true that our splendid body of over 300,000 patriotic American Radio Amateurs, scattered thickly all over the country, can be of inestimable value to the Government? Can not our red-blooded boys be trusted to assist our officials in running down spies, who probably would not be readily located otherwise? In our big cities thousands of ears listen every minute of the day to what is going on in the vast ether-ocean. Trust our very capable American youths to ferret out the senders of questionable signals or strangely worded messages. The very multitude of these amateurs is a priceless protection. Then again both our Army and Navy badly need Radio operators. What other country can furnish such a vast army of well trained and intelligent operators as ours, thanks to the amateurs?

When in 1916 the writer organized the *Radio League of America*, he incorporated in its statutes that every member should pledge in writing his station to the Government. Up to this moment the League has forwarded to Washington thousands of such pledges, among them every important amateur station in the country. These stations can be used by the administration at a moment's notice. At least our amateurs are fully prepared.

Would it not be questionable wisdom to shut down all these stations that can and will do enormously more good than possible harm?

Let our officials ponder and let them consider fairly the facts in the case. That is all that we desire.

H. GERNSBACK.

THE ELECTRICAL EXPERIMENTER is published on the 15th of each month at 233 Fulton Street, New York. There are 12 numbers per year. Subscription price is \$1.50 a year in U. S. and possessions. Canada and foreign countries, \$2.00 a year. U. S. coin as well as U. S. stamps accepted (no foreign coins or stamps). Single copies, 15 cents each. A sample copy will be sent gratis on request. Checks and money orders should be drawn to order of THE EXPERIMENTER PUBLISHING CO., INC. If you change your address notify us promptly, in order that copies are not misrouted or lost. A green wrapper indicates expiration. No copies sent after expiration.

All communications and contributions to this journal should be addressed to: Editor, THE ELECTRICAL EXPERIMENTER, 233 Fulton Street, New

York. Unaccepted contributions cannot be returned unless full return postage has been included. ALL accepted contributions are paid for on publication. A special rate is paid for novel experiments; good photographs accompanying them are highly desirable.

THE ELECTRICAL EXPERIMENTER. Monthly. Entered as second-class matter at the New York Post Office, under Act of Congress of March 3, 1879. Title registered U. S. Patent Office. Copyright, 1917, by E. P. Co., Inc., New York. The contents of this magazine are copyrighted and must not be reproduced without giving full credit to the publication.

THE ELECTRICAL EXPERIMENTER is for sale at all newsstands in the United States and Canada; also at Brentano's, 37 Avenue de l'Opera, Paris.

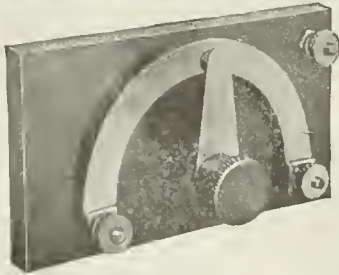

GRAPHITE POTENTIOMETER

5000 ohms resistance insures long life to batteries. Carbon contact insures long life to instrument. Don't ruin batteries and instruments with inferior imitations.

CHARGE STORAGE BATTERIES from alternating current with the BLITZEN RECTIFIER. Safe, clean, economical.

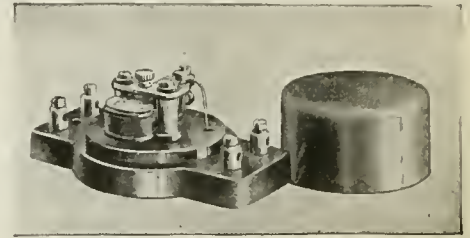
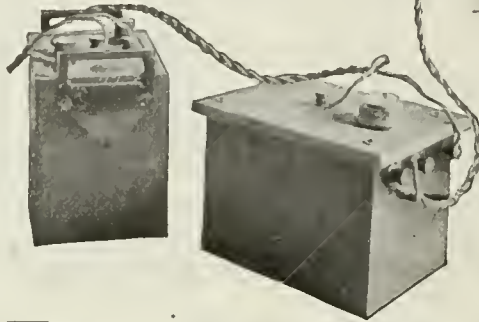

HIGH FREQUENCY, HIGH QUALITY TEST BUZZER

The smallest, neatest and highest pitched buzzer on the market.

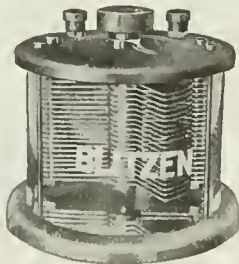

ROTARY VARIABLE CONDENSER

Our small condensers, either 17 or 43 plates, are a little better value because a little better quality. Our catalog tells why.

ONLY A FEW

instruments selected from our new Catalogs can be shown here. Complete catalogs of Wireless and Electrical Apparatus. Storage Battery Chargers, Parts and Supplies sent for 6c stamps to defray postage.

CLAPP-EASTHAM CO.

141 MAIN STREET CAMBRIDGE, MASS.

Western Representatives

Southern California Electric Co. 625 S. Main St., Los Angeles, Calif.

Berk Electric Co. Portland, Oregon



THE BLITZEN WAVE METER

A very attractive meter in portable form furnished in several types at a very moderate price. Mahogany case with hinged cover.

DAY NIGHT

TRANSCONTINENTAL

SUMMER WINTER

Your Relay Organization Demands,

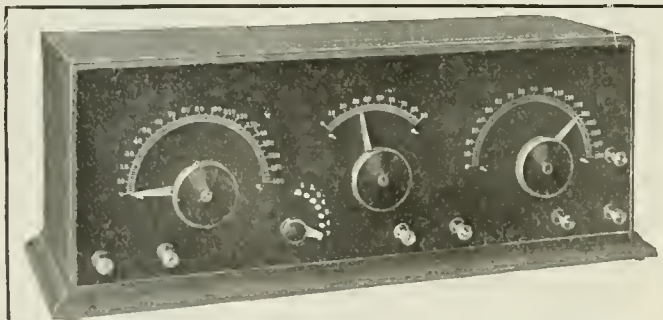

"PARAGON" RA-6 Amplifying Short Wave Receiver. Range 180 to 580 meters. Price \$35.00.

The weaker the signal, the greater the amplification; The greater the amplification, the greater the selectivity.

for efficiency, Transcontinental relay work, day or night, summer or winter

Its Users Will Tell you That the "PARAGON" RA-6 has made this possible;

That its amplifications are marvelous; its selectivity a delight.

That it is the only amplifying short wave receiver.

That it is covered by a 2-year-satisfaction-or-your-money-back guarantee, and that we back this guarantee.

And Furthermore, that we guarantee the "PARAGON" RA-6 to so far excel other short wave receivers that there is no comparison.

We list below a few of the users of this instrument. Ask them!

- 1VN 2BE 2FS 2IM 2ZS 3AEP 3WN 5DU 9ZN
- 1ZM 2BO 2AGJ 2PM 2ZL 3AFA 3ZS 7ZR 9GY
- 1ZW 2EX 2AFT 2RL 2ZK 3UF 4EI 8JZ 9MQ

"Paragon" Instruments Set New Standards

A Stamp will bring you Bulletin "O" which describes the most efficient line of apparatus ever offered

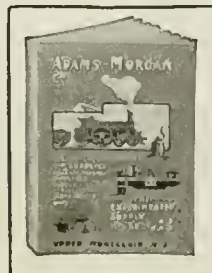

Send 8c for Our CATALOGUE No. 8

Now on the press. Contains several pages of tables, practical formulæ and information of real value—several hundred different parts and sets of parts, and complete descriptions and prices of all the latest electrical and wireless apparatus

Adams-Morgan Co., 13 Alvin Place Upper Montclair, N. J.



THE ELECTRICAL EXPERIMENTER

H. GERNSBACK EDITOR
H. W. SECOR ASSOCIATE EDITOR

Vol. V. Whole No. 49

MAY, 1917

Number 1

A One-Man Electric Submarine

By H. WINFIELD SECOR

WHILE Henry Ford has been urgently advocating the use of a one-man submarine of more or less efficacy, and comprising among other things a long collapsible pole extending from the miniature submarine, on the end of which there is supposed to be placed a torpedo or bomb which is to be exploded by the operator within the submersible, a number of other enterprising inventors have been engaged on

ception of one of these demons of war making its attack on the hull of a mighty Dreadnought, with a magnetic bomb properly timed to explode a few minutes after its attachment, in order to give the operator of the one-man submersible sufficient time in which to get far enough away from his victim to protect himself.

In the first place, it is the inventor's idea to make up these miniature submersibles of about the same size as the modern auto-

at two hundred horse-power for the above range, if the craft is to make a speed of 42 knots or approximately 50 miles per hour. In the event that the navigator of such a submersible should have to make a detour in order to get back to the mother-ship or to his shore base, it would be advisable to equip the boat with an auxiliary gasoline engine as shown in the accompanying illustration. Most probably under ordinary conditions, the operator of

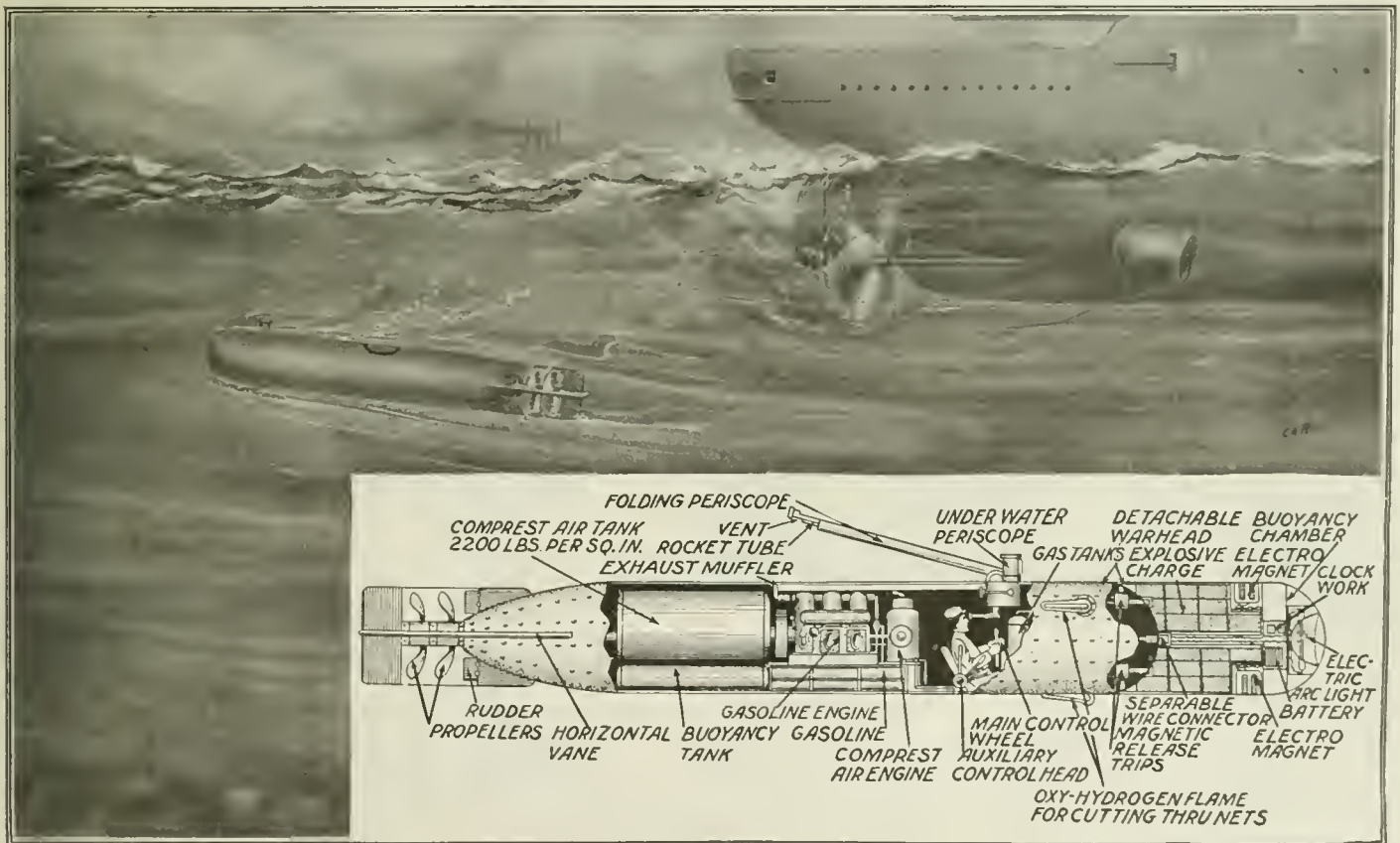

The One-man Electric Submarine Here Shown in Detail and Also in Action Has Considerable Promise. It Can Dart Thru the Water at Torpedo Speed (50 miles per hour) When, Having Attached Its Magnetic "War-head" Containing the Gun-cotton and a Time Fuse to the Hull of an Enemy Vessel, It Can Easily and Quickly Make Its Escape at Mile-a-minute Speed. It Should Prove Ideal for Coast and Harbor Defense.

a similar yet somewhat different problem. One of the most promising of these designs for a one-man submarine is that of Mr. Eric R. Lyon, the engineer who was responsible for the mastodontic two-hundred-foot high electric gyro-cruiser featured in our February, 1916, issue.

The accompanying illustration shows a detailed view of a one-man electro-mechanical submersible along the lines laid down by Mr. Lyon, and also an artist's con-

mobile torpedo, or measuring say 25 feet long by 3 feet in diameter. This compares approximately with the dimensions of the latest type U. S. torpedo with a range of ten thousand yards or 5.7 miles. When compress air is utilized for propulsion, the air being stored in the tank at two thousand pounds pressure to the square inch, the compress air engine used in the modern torpedo (and which could be adapted to the one-man submersible) is rated

this new war engine would have no trouble in getting back to his base of operation by means of the compress air equipment. It has been claimed by Mr. Ford and other investigators that it is now possible to operate a gasoline engine under water by means of special absorption apparatus attached to the exhaust manifold of the gasoline or other engine, and that this means of propulsion can be attached to submarine war vessels. If such is the case, then it

"ELEVATING" CENTRAL.

The upper stories of the West Palm Beach Telephone Company's office in Florida, which has just had two floors added to it, was the scene of a remarkable engineering feat recently.

Under the new arrangement it became necessary to remove the big switchboard, at which the operators sit and make the connections that enable people to communicate with each other on an infinite variety of subjects, important or affectionate or merely frivolous, from the third to the fourth story. The move was made in the following simple but effective manner.

A platform composed of two pieces of 4x6 timber, on which was laid a floor of

2x12 planks, was built under the heavy switchboard—wide enough to accommodate the operators' chairs around the edge of the board. Slings were then placed about the whole business, to which a tackle and three heavy differential blocks, each capable of handling a weight of four tons, attached to a sling of log chains fastened

to a heavy beam at the top of the fifth story.

The switchboard, with the girls seated at it, and still carrying on their work, was hoisted thru a hole in the floor of the fourth story.

The work was carried on without a hitch, and the girls remained suspended until the floor had been rebuilt under the switchboard. There was not the slightest interruption to business from first to last during the ascent. Nor did the subscribers, talking over the switchboard, suspect in their wildest utterings, that "Central" Switchboard Girls—chewing gum and all—were moving skyward, angel-like, all the while.

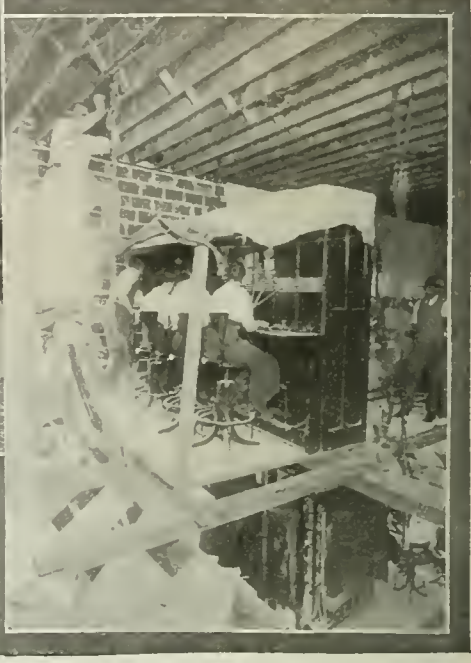
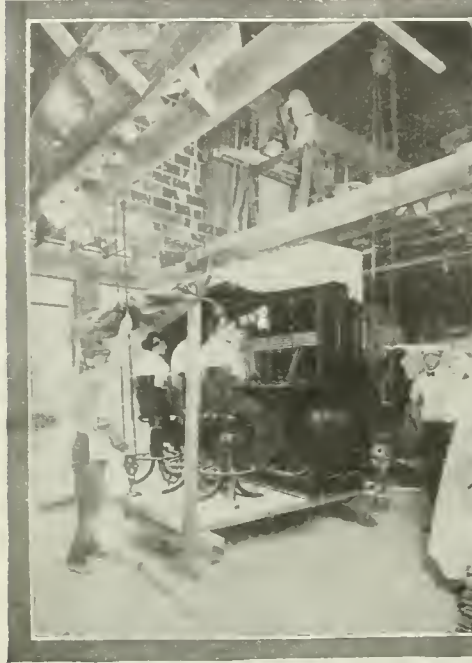

Left:—All Aboard! Central Girls, Switchboard, Wires and All Prepare to Be Elevated From One Floor to Another.

Above:—Going Up! Three Husky Chain Blocks Lift the Central Switchboard Complete.

Right:—At Last! Central's Elevation Completed. No Interruption in Traffic and the Girls Are 10 Feet Nearer Heaven.

will mean that the one-man submarine will become all the more practicable.

Coming down to the means whereby this novel engine of war is to be used in carrying out offensive operations, we see upon looking over the detail drawing that in front of the submarine there is a detachable *war-head* in the form of a steel cap which fits against the parabolic nose of the submarine very tightly. This war-head contains the usual quantity of gun-cotton or other high explosive. Suitable quick-acting magnetic clutches enable the operator to instantly release the entire war-head at any desired moment.

This submersible not only carries two distinct forms of prime mover, but also carries the necessary gas tanks to supply a set of ultra-powerful oxy-acetylene flame nozzles, suitably disposed about the forward part of the vessel on the exterior, and by means of which the operator can burn his way thru any ordinary submarine net entanglement.

This feature is one of the latest scientific discoveries and involves the operation of an oxy-acetylene flame *under water*, which is made possible by blowing a stream of compressed air around the gas nozzle, and in this way forming a flame pocket in the water so to speak.

Mr. Lyon is very enthusiastic on this particular innovation, and has drawn plans for a one-man submarine which utilizes an extra powerful and especially contrived set of these high power oxy-acetylene nozzles with which to burn a hole thru the bottom of a Dreadnought, causing it to founder sooner or later.

Among the other interesting features of the idea here pictured we find a collapsible periscope which may be folded down into a suitable pocket provided in the top of the hull, and attached to which there is an air tube and also a (distress) rocket chute. When running submerged, a special air machine is used to supply the necessary oxygen to the navigator. A powerful electric searchlight is fitted to the front of the detachable war-head and by means of the small periscope shown the operator can see ahead at a considerable distance under the water. A compact but powerful battery is contained in the war-head which can supply sufficient energy to energize the electromagnets which hold the explosive chamber to the hull of the enemy war vessel once the operator has managed to approach close enough to accomplish this result.

The war-head also carries a special electric time switch, which functions a few minutes after the war-head has been attached magnetically to the hull of the enemy vessel, and which causes an electric spark to detonate the gun-cotton charge.

It has been argued by a number of naval experts that the *One-man Submarine* is doomed to failure for several different reasons. This, however, does not seem to be the case so far as we can see, and providing the submersible is properly designed in its details.

Let us take a concrete case for example to show how the Lyon one-man ship destroyer would go about its task.

Assuming that these engines of destruction, of which there would be most probably several in each attack to make doubly

sure that the enemy would not escape, have been despatched either from a fort or other point on the coast, or from a mother-ship several miles distant from the enemy, the intrepid navigator of the 50-mile-an-hour submarine starts forth on his perilous journey. With only his periscope exposed and at a distance of several miles, it is well known that a periscope projecting a foot or so above the water presents an almost impossible target for ordinary gun-fire, and moreover, as the vessel darts forth on its way and as the range decreases between himself and the enemy, the buoyancy and submerging tank motor-pumps are manipulated so that only occasional sightings are made with the periscope. It thus becomes very problematical whether the enemy could hit the submarine. Also at a distance of say one mile, and in accordance with standard submarine maneuvering the submarine officer then proceeds to take accurate sightings of the enemy both with regard to the range and the direction geographically, after which he submerges and may proceed at high speed at a depth of fifteen to twenty feet below the surface of the water (the same as modern torpedoes) and in a little over a minute or so, and providing he has gaged the enemy's position accurately, he will find himself in the vicinity of the bottom of the hull. Owing to the high speed possible with this miniature submarine, built like a torpedo, it should be possible for the navigator (in the event that he does not strike his mark, when he has gone the range calculated up-

(Continued on page 47)

Electrifying the Aeroplane

ELECTRICITY is being rapidly introduced in the new art of Aeronautics as the illustrations herewith tend to testify. The greatest development in the art of flying is the aerial limousine or so-called *Autoplane* illustrated in Fig. 1, which was exhibited at the recent aeroplane show held in New York City. This aeroplane is built in the form of an automobile limousine and equip with three planes for the sustaining surface. Aside from its perfect mechanical features its electrical equipment is exceedingly interesting, as the engine is automatically started by means of an electric motor installed exactly the same as the mod-

ern automobile engine electric starter. The engine develops 100 horsepower and drives a four-bladed propeller placed at the rear. The interior lighting is accomplished entirely by electric lamps and its ignition is of the very latest electrical design. Altho it may seem that the machine was not made for speed, yet it has a speed range of sixty-five miles per hour and can sustain a weight of 710 pounds. It can carry two passengers and a pilot.

the minimum air speed has been reached. It is mounted in any convenient position where the air flow is unobstructed. The stallometer is adjustable for any desired air speed, depending on the aeroplane on which it is installed. When the predetermined speed is reached, an electric contact is closed in the stallometer, closing the circuit thru an indicating lamp

at a dangerous angle. The white lamp signals whenever the pilot dives at too steep an angle. The green light indicates the best climbing angle. Being of low voltage as well as low current consumption, the lights can be operated on a dry battery, encased in metal and installed wherever most convenient. The signals are regulated by a vane operated by the air stream.

The lamp bank container is seen in the background. Each lamp is equipped with the proper colored screen and each connected to the required contacts enclosed in the incidence indicator chamber. The lead wires are led thru one of the supporting tubes.

Aviators wishing to know at



Fig. 1. The latest in flying machines—the "Autoplane." It is an aerial limousine.

Fig. 3. Electrically operated "Incidence Indicator" for showing best gliding and climbing angles.

Fig. 4. Dead-beat "Clinometer" which shows angle of aeroplane with the earth.

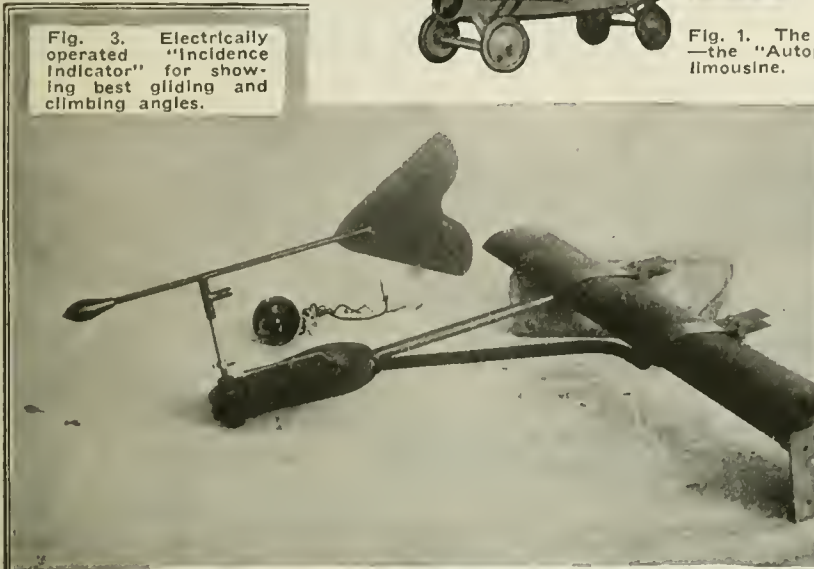

Fig. 2. The electric "Stallometer" warns the aviator when his machine is approaching a stalling condition by indicating that the minimum air speed has been reached.

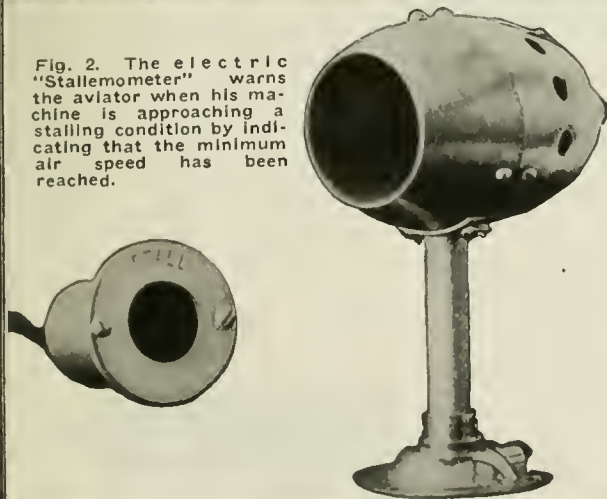

Fig. 5. The "Sperry Automatic Pilot" which, by means of electric driven gyroscopes, serves to control and maintain an aeroplane in any desired position; the pilot may drop bombs, etc.

ern automobile engine electric starter. The engine develops 100 horsepower and drives a four-bladed propeller placed at the rear. The interior lighting is accomplished entirely by electric lamps and its ignition is of the very latest electrical design. Altho it may seem that the machine was not made for speed, yet it has a speed range of sixty-five miles per hour and can sustain a weight of 710 pounds. It can carry two passengers and a pilot.

The stallometer illustrated in Fig. 2 is an electric instrument devised to warn the aviator when his machine is approaching a stalling condition by indicating that

mounted on the instrument board stationed in front of the pilot.

An incidence indicator increases the efficiency of an aeroplane by warning the aviator before he stalls and by enabling him to get the best climbing and gliding angles out of his machine.

The transmitter of the Incidence Indicator in Fig. 3, is mounted on a forward strut so as not to interfere with any part of the plane. The lamp bank or indicator is on the instrument cowl, always visible to the pilot observing other essential instruments. The red light warns the aviator before he stalls as well as when he begins climbing

any time the correct fore and aft position of the machine, with reference to the horizontal, can read it on the scale of the dead-beat clinometer illustrated at Fig. 4

The operation of this instrument is simple. Whenever the clinometer is tipped forward or backward by the motion of the plane, this movement is registered on a scale mounted on a wheel which is damped by floating in a liquid.

If the aeroplane tips forward, the scale moves upward, indicating in degrees below the zero line the exact angle. If the machine tips backward, the scale moves down-

(Continued on page 54)

The Autograph of Your Heart

By SAMUEL COHEN

ONE of the most important mechanisms of the human body is the Heart. Its action in health and disease has been the subject of attention by numerous prominent physicians in all parts of the world, par-

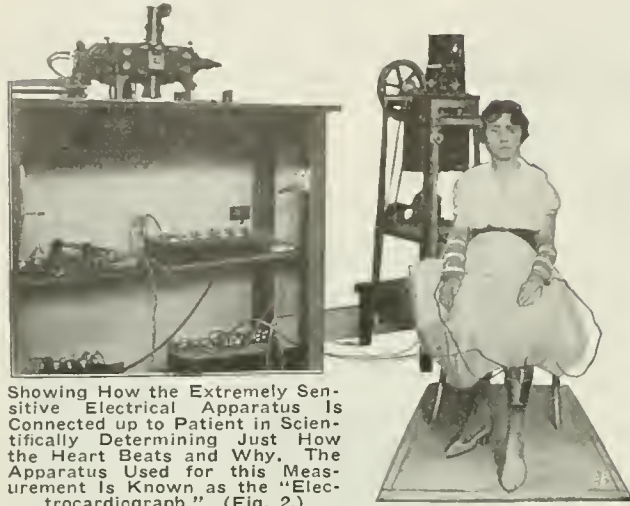

Showing How the Extremely Sensitive Electrical Apparatus Is Connected up to Patient in Scientifically Determining Just How the Heart Beats and Why. The Apparatus Used for this Measurement Is Known as the "Electrocardiograph." (Fig. 2.)

ticularly those interested in fighting *heart disease*, the most unrelenting malady with which one can be stricken. Yet it has been said that 15,000 to 20,000 school children in New York alone are suffering from it.

In view of its most important function and delicate structure, cure, by way of operation, is usually impossible. Therefore, the only thing left is to carefully study the heart, locate the trouble and determine the reasons for this trouble. A first aid in this direction is a biographical history of the patient.

The rapid growth of this disease, and the rapid advancement of science, has led to the development of a new instrument called the *Electrocardiograph*. This instrument is really a modified Einthoven galvanometer, consisting of a very powerful magnetic field produced by an electromagnet and excited by a constant direct current, such as the current given by a storage battery. A very short air gap is made between the poles of the magnet and in this powerful field a fine quartz filament or fiber is stretched. Delicate adjusting means are provided for controlling the tension of this wire. (See Fig. 1.)

A small diaphragm is placed on the center of this which closes two small holes that extend thru in each pole piece. These holes are the condensing microscopes and the projecting microscope to focus a fine beam of light to strike a moving photographic film. If the wire is slightly displaced by the passage of an electric current thru it, it will naturally displace the small diaphragm and in turn permit the fine beam of light to pass thru the openings and strike the film placed opposite to the projecting lamp throwing out the fine beam of light. It will, therefore, be seen that by displacing the quartz wire in certain movements that a record will be made on the film accordingly. This quartz filament is connected to a Wheatstone bridge of proper dimensions and also to special terminals which are connected to the pa-

tient whose heart is to be examined. These terminals are three in number and are made of German silver plates, each of them being fitted with binding posts connected to the leads, connecting the plates with the sensitive galvanometer and

Wheatstone bridge circuit. Two of the plates are secured to the arms of the patient, while the third terminal is strapped around the left ankle. Proper care is taken to see that the electrical connection between the body and the terminal is of low resistance and for this purpose a wet cloth which is saturated with a 20 per cent salt solution is placed between the foot and plate and again the cloth is wrapt about the plate. The Wheatstone bridge circuit is balanced so that the resistance of the electrical path between terminals is constant, and this is obtained when the quartz string or filament of the galvanometer is in

a zero position.

It is evident that a slight addition of current to the galvanometer circuit will cause a displacement of the filament, which is recorded on the film. Since the contraction of the heart creates an electric current as found by various scientists, and as the intensity of this current depends

IN the present article we have one of the most interesting and startling revelations of what medical science, plus electricity, is doing to bring about a clearer understanding of our bodily actions. Herewith is presented a true electrical record of a patient's heart, which shows the fluctuations occurring just before and at the critical moment when life ceased to exist. In other words, the patient died.

upon the intensity of the heart contraction, it is therefore obvious that the fine quartz wire will be displaced a certain amount by the generation of current by the heart. With the contraction wave, the electric potential spreads over the heart and thus the galvanometer records the heart beat and also indicates the origin and path by which the current spreads.

An exact replica of the apparatus used in recording the pulsation of the heart is illustrated in Fig. 2. This shows the apparatus in actual use and also how the various electrodes are secured to the patient. This photograph was taken at the time a record was actually being made of the condition of the patient's heart. The sensitive galvanometer is seen at the left, while the beam of light is derived from a powerful arc projector stationed at the extreme left, but not shown. The instrument at the extreme right is the photographic film apparatus. The film is driven at a definite and uniform speed by an electric motor mounted at the bottom of the machine. This instrument is placed in exact line with that of the telescope of the galvanometer pole-piece. The resistance box is shown on the shelf of the galvanometer table.

The instrument traces its indication of conditions in the heart by curves on the photographic film. These heart pictures

are as characteristic as finger prints or photographs. No two individuals' hearts beat alike, and the electrocardiograph, by its extremely delicate registration of the contraction of the muscle, readily shows the most minute difference.

A remarkable story of a *dying heart* is told by the accompanying curves registered by the electrocardiograph. The graphs illustrating this remarkable story are shown in the third figure, and these were taken by Dr. R. H. Halsey, of New York City.

The records here reproduced form an almost complete electrocardiographic record of the heart beat during the last movements of the patient's life. The death was expected, yet its actual advent was much earlier than had been anticipated; the transition from life to death was abrupt. The warning of change is to be found in the lengthened conduction interval and in the changed ventricular complex of Fig. 5. That fibrillation of the ventricles was not the immediate cause of death is clear from Fig. 6, taken when the usual signs of life were in abeyance; the heart was profoundly affected, and the patient past all possible hope of recovery before fibrillation ensued.

The record was obtained from a female patient thirty years of age, suffering from broncho-pneumonia of both lower lobes. The curves were taken one after the other in quick succession and are described in this order. In Fig. 1 the frequency of the heart is 75. The duration of the diastole* varies from 0.2 sec., to less than 0.1 sec., and is non-rhythmic. The up-stroke of P is quicker than the downstroke. The con-

duction time is within the normal limits of 0.2 sec. T is upward in its direction and of considerable excursion. In the second figure, the frequency of the heart is 80. There are the same vibrations in the duration of the diastole. The *electrocardiograph* Figures 3, 4 and 5 show the different frequencies of the heart at different periods. In curve 5,

the frequency of contraction of the heart appears to have dropt to 45, while association of auricle and ventricle is still present. The conduction time is 0.4 sec.; double the time in the earlier record. Dur-

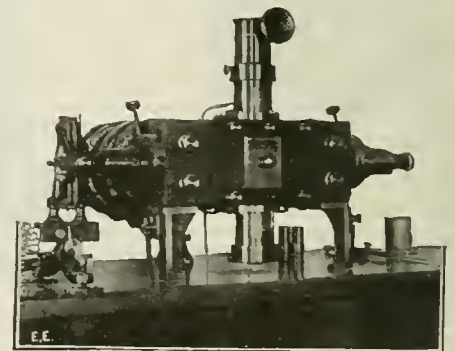

Close View of the Einthoven String Galvanometer Used in Actually Measuring and Analyzing the Infinitesimal Electrical Currents Produced by the Human Heart at Every Beat. Did You Know that Your Heart Was a Dynamo? (Fig. 1.)

ing the very brief interval between the taking of Figs. 5 and 6, convulsive gasps and a slow contraction of the skeletal muscles occurred. In Fig. 6, the change is re-

* Diastole is the period of rest between contractions of the heart.

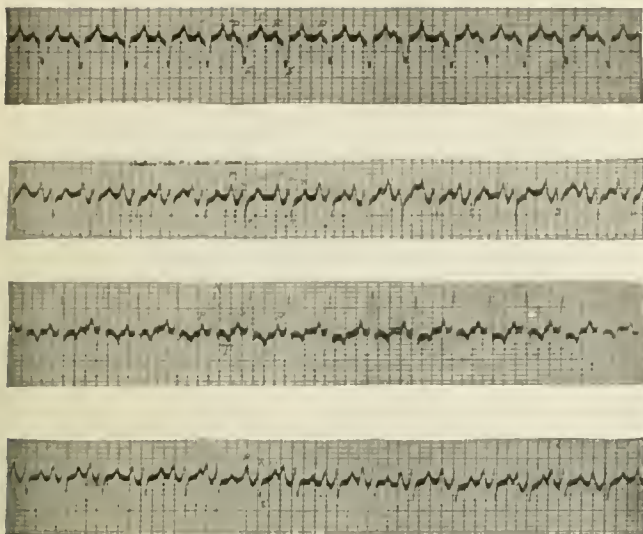

(Above)—Figures 1 to 4.

markable, and the frequency of the ventricle has increased to 63 per minute. The remaining complexes vary in their detailed form, but are similar in general outline. In Fig. 7, there are no evidences of coordinate ventricular contraction. The remaining records are similar; in Fig. 13, all movement ceased permanently, the patient having died.

When the heart takes a sudden jump to the fast rate, stops suddenly and returns to the normal rate, a typical curve is made as indicated above. This condition is called a "flutter." The auricles of the heart sometimes contracting three hundred times a minute and the ventricles only one hundred and fifty times a minute!

By the use of the electrocardiograph and a stethoscope connected with a microphone, the sounds made by the contractions of the heart are recorded with curves indicating the rhythm so that the exact point in the heart cycle of various normal and abnormal sounds may be recorded.

Electrocardiograph records showing the action of the heart under certain treatment may be made and sent to physicians in various parts of the world, who by interpreting the curves can obtain information of great value in the treatment of their own patients.

In order to standardize such records, the tension of the galvanometer quartz wire is adjusted so that a current of one-thousandth of a volt will deflect the filament to such an extent that its shadow projected on the recording film will move one centimeter in both directions! Since the wire is set to move a definite amount for a known voltage of current, the deflection shows the amount of current that caused it. The heart of the average individual causes a deflection which indicates the passage of a current of approximately one to two one-thousandths of a volt. Thus it is known that it would require the heart beats of thousands of persons to generate enough current to light an incandescent lamp.

In conclusion it may be said that the conditions of the human heart can now be studied with far greater accuracy than was ever possible heretofore, thanks to the Electrocardiograph.

RADIUM AND CANCER.

"The Other Side of the Radium Cure" is the title of an article by Dr. J. H. Blaisdell, in the *Boston Herald*. This is of such great interest that we give it below, as many of our readers have undoubtedly read the recent report of the Director of the Crocker Cancer Research Commission printed in these columns.

"Newspaper interpretation of medical subjects, vital to the interests of the health of the community," says Dr. Blaisdell, "should be peculiarly conservative and well advised. To me your editorial comments on radium in cancer on Wednesday

morning of this week seem especially open to criticism on this score.

"Briefly stated, your summing up of the findings of the Crocker cancer commission of Columbia University unqualifiedly placed radium in the discard as a 'cure,' damned it with faint praise as a palliative, and noted with the cheerful abandon of 'life opportunity given the medical profession to make the patient's condition worse than if he had been left alone.' Such is the pessimistic side of the picture based on truth but, unfortunately for your readers, only half the truth. Simply because radium cannot act as a 'cure' in inoperable or hopeless cases of systemic cancer is no reason why readers should be instructed to regard it as a discarded fad to the utter disregard of countless cases of early malignant disease that this remedy has saved.

"Point out rather to your readers (referring to the editor of the *Boston Herald*) the significance of the recent purchase of many thousand dollars' worth of radium by the Huntington Hospital of Boston, as an example of how useful it is in experienced hands. Tell them of its curative effects beyond that of any other remedy in epitheliomas or cancers of the skin. Lay your emphasis on how radium can absolutely prevent cancers of the skin if people could be taught to have the early pre-cancerous possibilities such as keratoses, warts, moles, etc., removed before degeneration starts. By such statements it seems to me you would be doing the greater services to the community and more rightly interpreting the findings of the Crocker Cancer Commission on Radium."

with forceps, and swallowed 175 milligrams of radium in three well-screened tubes. He refused immediate gastrotomy, and the tubes were past thru the alimentary canal at the average rate of nine inches per hour. No injury followed and he said: "None of the crowned heads of Europe have anything over me in luxurious repasts, for I have had the only distinction of the consumption of a \$20,400 meal."

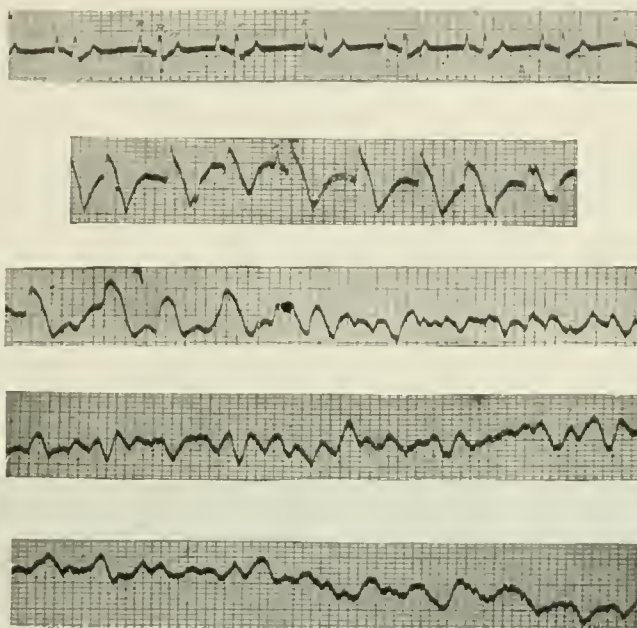

(Above)—Figures 5 to 9.

MAN SWALLOWED \$20,400 WORTH OF RADIUM.

In an article treating on the use of "Radium in Surgery and Gynecology" in *Radium*, Dr. John M. Lee relates a peculiar accident which happened in applying a valuable tube of radium. Sarcomata and epitheliomata of the tonsils in several patients have yielded excellent results. In one of my first cases, a vigorous, powerful man, with more money than judgment, jerked his head backward thru the supporting hands of the nurse, and at the same time yanked the mucous-smear and slippery braided silk thread out of my hand, just as I was about to seize the tubes in the pharynx

(Below)—Figures 10 to 13.

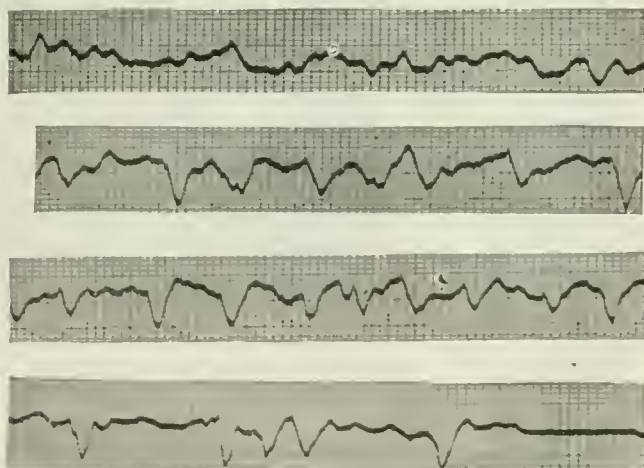

The Above Electrocardiograph Records, Numbered 1 to 13 Consecutively, Represent the Most Remarkable Scientific Analysis of Just What Does Happen in a Person's Heart Shortly Before and at the Exact Period When Life Ceases to Exist, or Death. By Inspecting These Charts of the Heart's Variations During the Last Moments of the (Female) Patient, a Victim of Bronchopneumonia One Can See How the Heart Started to Fluctuate Progressively, Finally Stopping Action at the Right End. (Fig. 13.)

Combating the Torpedo*

By H. GERNSBACK

WAR after all is but a game of chess. The greatest generals of modern civilization realized this so profoundly that every one of them had been at one time a good chess player. In war, as in chess, luck plays but an insignificant part. Given like equipment, the general who has the greatest strategical ability will win, whether it be in the field or on the chess-board. Also, if both opponents can sufficiently anticipate each other's moves, no one will win. In this case there will be a *stalemate*, as it has existed for over two years in France. But stalemates necessarily always denote equal strength of both opponents and a stalemate often turns out to be a negative victory, for it is certainly not defeat.

The present submarine warfare is no exception to the rule of comparing war to chess, for the simple reason that it is an uneven game—all the powerful pieces are on the U-Boat's side and no Queen, Rooks and Knights on the other side of the board to defend the King. At least there was no defense worthy of the name up to a few months ago.

But science, as always, is progressing steadily and soon the submarine will have found its master, or at least its equal, with which to stalemate it.

Let me first correct a popular illusion. Almost every one of us thinks or speaks of the "deadly submarine," when, as a matter of fact, the submarine itself is not only not deadly but a very weak contrivance at best. Point a 3-inch gun at it and it will vanish instantly. Send a 20-foot motor boat chaser against its periscope and the "deadly" submarine at once becomes deader than the proverbial doornail.

It is the submarine's deadly weapon—the torpedo—that has so far out-generaled the cleverest brains and has given the greatest statesmen untold sleepless nights. To fight the submarine itself is comparatively easy, given good guns and good gunners on board the attack ship, providing of course that the enemy submarine commander is foolish enough to expose his craft too much above the waves.

Several methods have been adopted of late to combat the submarine, none of which have been great successes.

First, we have the smoke-screen—perhaps one of the most effective schemes developed lately. By means of dense volumes of chemical smoke, blown around the ship by powerful exhaust pumps, the ship is enveloped almost completely in a fog-like screen and it becomes a very difficult target for a torpedo. The ship's bow, how-

ever, is nearly always exposed. The other method is to protect the ship with strong torpedo netting suspended by means of booms from the ship. The torpedo upon striking the net is thus rendered harmless, as it never reaches the ship, unless the netting is made of rope and the torpedo is equipt with cutting blades. In that case the torpedo will strike the ship and blow it up.

But the one great drawback of the net-

OUR readers will find much food for thought in this interesting article. While the idea may not effectively stop enemy submarines from torpedoing every merchant vessel, we feel confident that we have shown a fairly practical way to obtain satisfactory results.

Mr. Gernsback is donating his invention to the Nation and he wishes it to be understood that he will not require to be paid royalties or any other considerations from American ship owners. Foreign ship owners are not included in the above.

ting is that it is almost impossible to use it on a fast moving ship. It is too cumbersome and most important of all it greatly retards the speed of the ship, due to the excessive friction of the netting against the water.

The next—and poorest—means to combat the submarine is our widely advertised mounting-guns-on-a-ship scheme. No submarine commander in his right senses exposes more than one or two feet of his periscope when making a torpedo attack. And remember no torpedo attack is ever made at a closer range than 800 yards. Two thousand, and even four thousand, yards are very common nowadays. Imagine a gunner on even a slightly rolling ship trying to hit an object one foot high

ertheless is of distinct use, in so far as the guns will keep a submarine at a respectful distance and prevent the U-Boat commander from attacking the ship by means of his own gun-fire. But mounting guns on ships will never prevent a torpedo from finding its deadly mark. You can't shoot at a torpedo—the bullet is too small and the modern torpedo making 43 knots, i.e., 50 miles an hour, moves far too fast.

After much thought on the subject, I came to the conclusion that in the torpedo itself we have an effective weapon to combat the torpedo, strange as it may sound at first. You can combat a gun with another gun, and you can combat one rifle with another, as well as you can fight one aeroplane with another.

Why not combat the torpedo with another torpedo? It is all very possible and simple if you know how; as a matter of fact the idea struck me so favorably that I decided to apply for patents in all civilized countries.

Several navy experts have reported favorably on the idea, and while up to this writing no ships have been equipt with the device, I would not be at all surprised to see the idea put into practise very shortly.

Our front cover and the two accompanying drawings illustrate the idea clearly.

The underlying idea of the whole scheme is that it takes the torpedo an appreciable length of time between the instant of being released from its submarine and the moment it strikes the attacked ship. Taking the closest range at which a torpedo can be fired as 800 yards—and it cannot be fired much closer successfully—this gives

a time of 55/100th or over half a minute to cover that distance, short as it is. Taking the average range of 2,000 yards, it will take the torpedo 138 minutes before it will strike. These figures are for the latest type Bliss-Leavitt torpedo making 43 knots, i.e., 50 miles an hour.

But a torpedo, whether it runs on the surface of the water or submerged below it, always leaves a very noticeable "wake" in its course. Remember a torpedo is propelled solely by compressed air, compressed up to 2,200 lbs. per square inch. This air must of necessity come to the surface of the water, as the torpedo runs over its course. The disturbance created thus gives rise to the al-

most snow-white wake, which is very noticeable from a distance. Thus a man stationed on a ship readily sees the wake as it comes nearer and nearer and he can gage pretty accurately just where the torpedo will hit. Escape for the comparatively slow-moving ship is impossible, even if the engines were reversed instantly. The vessel's momentum would still be so great

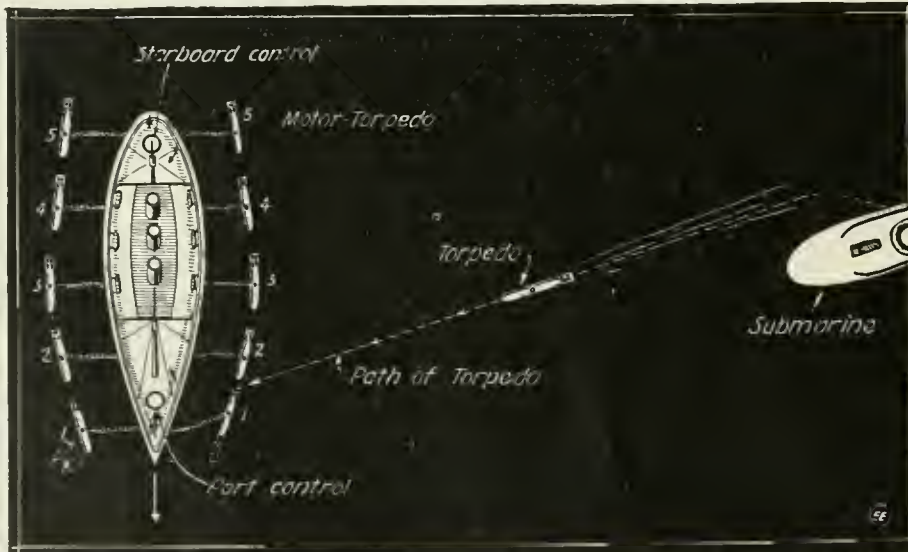

Top View of Ship with Its Ten "Motor-Torpedoes" Which Operate Independently from the Steamer. An Approaching Enemy Torpedo Is Blown Up or Thrown Off Its Course by Exploding One or More of the Little Motor-Torpedoes at the Critical Moment. Note that the Modern Torpedo Leaves the Submarine in a Curved Line After Which Its Gyroscope Rights It on the Final Straight Run. (Fig. 1.)

and less than six inches in diameter, at a distance of 3,000 yards! It simply can't be done. Scoring a hit under such circumstances is pure chance, and don't forget that the periscope itself does not stand still either. It, too, bobs up and down. In fact, at such a distance it is often almost invisible.

Mounting guns on merchant vessels nev-

*This article appeared originally in the Sunday "New York American" of April 15th.

that the deadly torpedo would surely find its mark.

My proposed means of rendering enemy torpedoes ineffective is as follows: Fig. 1

sees to it that the speed of each torpedo keeps up exactly with the speed of the ship, for there should never be a drag on the cables. This is readily accomplished by

into the torpedo and thence into the detonator placed in the gun-cotton charge. Fig. 2. Throwing this switch will blow up our torpedo.

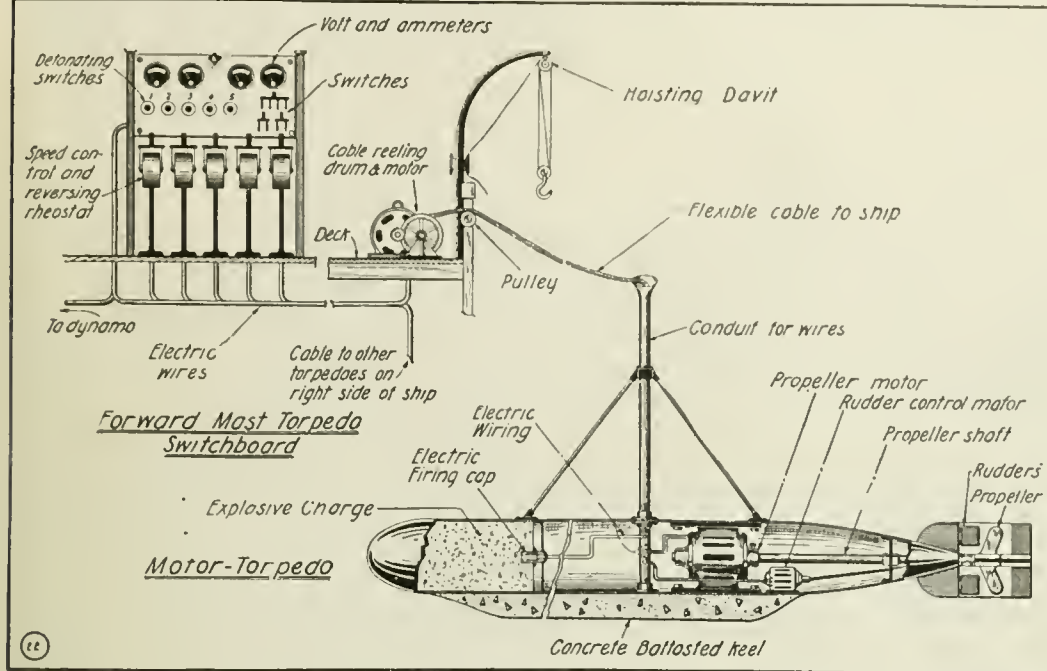

Fig. 2. The Electrically Propelled and Electrically Steered Gernsback "Motor-Torpedo." It is from 15 to 20 Feet Long and Runs Independently from the Mother Ship. An Operator High Up on the Ship's Mast Blows Up the Motor-Torpedo by Electric Contact as Soon as the Enemy Torpedo Approaches Within 15 Feet. Both Torpedoes are Thus Destroyed.

shows the plan view of an average steamer, 600 feet long. On each side we observe five (or more) independent, electrically propelled torpedoes. Fig. 2 shows the construction of the torpedo itself. Briefly, it is built along the shape of the regulation torpedo and measures from 15 to 20 feet in length and from 3 to 5 feet in diameter. It has a 12 horse-power electric motor geared to the propellers and there is also a little 1/2 H.P. motor geared to the rudder with which to steer the torpedo. Most of the space between the war-head and the motors is taken up with the usual charge of gun-cotton. This torpedo, unlike its other brethren, has a heavily weighted keel to prevent it from rolling over, for reasons which will be apparent later. On the back of the torpedo is mounted a steel mast-like structure thru which the control cable passes. This cable then runs to the deck of the ship over pulley arrangements as shown in Fig. 2. There is also a drum to take up the slack of the cable, or to play out more cable should the occasion arise. The cable then runs up on the mast into a special turret located as high up as is feasible. Here we find one or more operators sitting in front of the electric control-board. All the cables from the star-ward side torpedoes run into the forward mast-turret, while all the cables from the port side torpedoes run into the rear mast-turret. Thus each set of operators watches out for the safety of his side of the ship.

means of rheostats, one for each torpedo. By cutting in more or less resistance the 12 H.P. motor can be made to run faster or slower and the torpedoes are thus easily controlled as to speed. By means of a double-pole, double-throw switch the little 1/2 H.P. motor is revolved in either direction, thus effectively steering the little craft so that it will always keep at a distance of some fifty feet from the mother ship. On the control board furthermore there is a switch connected to a storage battery from which wires are run thru the cable

2, he leaves No. 1 in its original course but by cutting out more resistance from rheostat No. 2, he speeds up the latter with the result that it advances faster than the ship and in this case as well it will intercept the course of the enemy torpedo.

Suppose he decides to use motor torpedo No. 1. He has nearly two minutes to jockey it for position and he will find little trouble to intercept the course of the hostile engine of death. His eyes glued to the enemy torpedo (or to its wake), his

(Continued on page 68)

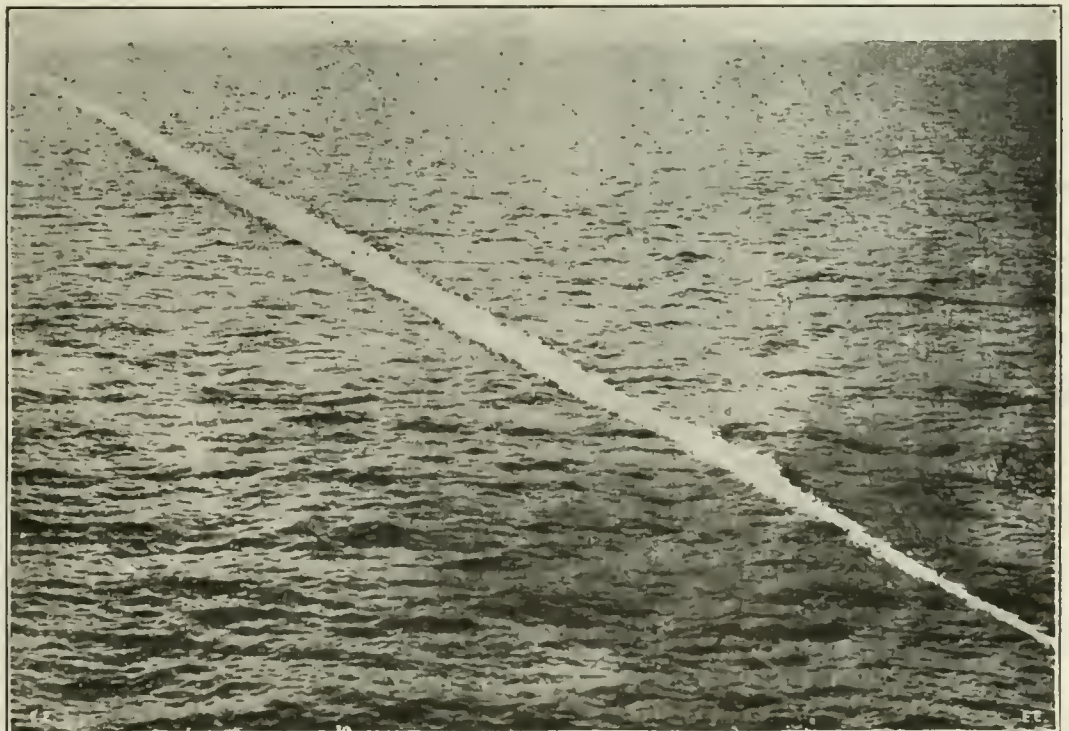

An Actual Photograph of the "Wake" of a Modern Torpedo. Attention Is Called to the Fact That This Particular Torpedo Ran About 10 Feet Under Water, Having Been Fired by a Submerged Submarine.

Photo by Paul Thompson.

All of the torpedoes are painted in such a color that the operator can watch them readily and guide their individual course. Sitting at the control-board the operator

Sources of Electricity

WHILE most of us are familiar possibly with several sources of electrical energy, we do not always stop to think of the many possible sources which are little known, especially to the layman. We have endeavored in the present article, and with the aid of the accompanying full page illustration, to describe the principal known sources of electricity.

Static Electricity: This form of electricity is that which we see when we stroke pussy's fur in a dark room and obtain a spark when the hand is withdrawn from contact with the fur; or again, we may obtain the same form of electric shock or discharge by rubbing together two dissimilar substances, such as a stick of sealing wax with a silk handkerchief, after which it will be found that the electrified stick of sealing wax will attract bits of paper or small pith balls. A rapidly moving belt often develops a considerable amount of static or frictional electricity, which will tend to discharge to earth whenever possible. One may often stand near such a belt, and by holding the knuckles or even the ends of the fingers near the belt, a heavy static discharge will take place between the belt and the fingers, the electric charge passing thru the body to earth.

One of the usual and practical sources of such electricity is the *static machine* (Fig. 1) and when the handle of such a machine is turned, one or more insulating discs are rapidly rotated, and by successive intensification of a very slight electric charge existing on the tin-foil sectors of these plates before the machine is started up, a surprisingly powerful static discharge is rapidly built up. This will manifest itself in the form of an electric spark, which crashes across the gap between two metal balls on the side of the machine. There are many other sources of static electricity but the whole phenomenon is practically the same.

Contact Electricity: It was Volta who showed that the contact of two dissimilar metals in the air produce opposite kinds of electrification, one becoming *positively*, and the other *negatively* electrified. There has been considerable discussion as to the exact action occurring in the production of electrical currents by the contact of two dissimilar methods in air, and for a long time, says Silvanus P. Thompson, the existence of this *electrification by contact* was denied, or rather it was declared to be due (when occurring in voltaic combinations) to chemical actions going on; whereas, the real truth is that the electricity of contact and the chemical action are both due to transfers of electrons between the substances under the peculiar actions of forces, about which very little is known with certainty as yet.

Volta found that the difference of electric potential between the different pairs of metals was not all equal, as while zinc and lead were respectively positive and negative to a slight degree; zinc and silver proved to be positive and negative to a much greater degree. The voltage obtained by the contact between zinc and carbon is 1.09 volts.

The phenomena of electrical currents produced by the contact of dissimilar methods is illustrated by Fig. 2. A difference of potential or voltage is also produced by the contact of two dissimilar liquids. It has been found that a liquid and a metal in contact exhibit a difference of potential or voltage, and if the metal tends to dissolve into the liquid chemical, there will be an electro-motive force acting from the metal toward the liquid. A hot

metal placed in contact with a cold piece of the *same* metal, also produces a difference of potential, and lastly Sir Joseph J. Thomson has demonstrated that the surface of contact between two non-conducting substances, such as sealing wax and glass, is the seat of a *permanent* difference of potential.

Galvanic Electricity: The primary battery is generally defined as one in which electrical energy is produced by chemical means, without having to charge the battery from dynamo or other source originally. The simplest form of such a battery comprises a glass or other vessel containing sulfuric acid and water, or any other oxidizing acid solution, and in which are immersed two clean metal strips, one of zinc and one of copper. Most of us are probably familiar with the common form of primary battery used in American practice for ringing bells and operating medical coils in the form of the well-known *dry cell*, or with the zinc-copper-salamoniac cell. In the zinc-copper-acid cell above mentioned, a continuous flow of electricity may take place thru a wire or apparatus which connects the two plates. When such a current passes, the zinc strip may be seen to waste away, or decompose by the electro-chemical action taking place, and its consumption, in fact, furnishes the energy required to drive the current thru the cell and the connecting wire or apparatus. In such a cell, the zinc strip forms the *positive electrode* or negative terminal, while the copper strip forms the *negative electrode* or positive terminal. Such a cell gives about one volt potential.

Fig. 3 shows a unique form of primary battery known as the *Hauck Circulation battery*. In this battery, composed of several cells, the electrolyte or solution is caused to pass from a tank above the battery cells, thence thru the first or higher cell, then thru the next lower container, etc. This is a chromic acid battery with carbon and zinc electrodes. The zincs are located in the rectangular porous cups while the two carbon plates are outside of the porous cups, all the space between porous cup and carbon plates, as well as between the carbon plates and glass vessel being filled out with small carbon pieces. In the porous cup there is a sulfuric acid electrolyte, while the carbons stand in chromic acid. As the latter is caused to circulate continuously from one battery to the next, all polarisation is done away with and we obtain a very steady and powerful current. The battery illustrated gives 6 volts and 60 amperes and can be used to charge storage batteries, run fans, or electric lamps. It is one of the best chromic acid batteries ever designed.

Electricity from Gases: Fig. 4 shows the famous Grove Gas Battery invented in 1839. It shows how two gases are used to produce an electric current. The two glass tubes contain platinum strips coated with spongy platinum. The glass bottle contains acidulated water in which the two glass tubes plunge, as seen. One of the tubes contains oxygen, the other hydrogen, as will be noted the gases make contact with the acidulated water. If we connect the two terminals with a galvanometer we will observe an electric current, the oxygen furnishing the positive, the hydrogen the negative pole of the battery. Incidentally we note that, as we consume current, the liquid rises in the two glass tubes, but twice as fast in the hydrogen tube as in the one containing the oxygen. As each tube is identical with the other, except for the gases, it follows that the current can be due only to the gases. Also different gases

produce different voltages and currents.

Pyro-Electricity or Electricity from Crystals: In the accompanying Fig. 5, we have several methods by which minute quantities of electricity are produced from crystals, when these are manipulated in a specific manner. Certain crystals, when they are heated or cooled, exhibit electrical charges at certain regions or poles, and such crystals which become electrified by heating or cooling are said to be *pyro-electric*. One of the principal crystals which manifest this peculiar action is *tourmaline*. The tourmaline has been cited in history, and is mentioned by Theophrastus and Pliny under the name of *Lapis Lyncuricus*. The tourmaline possesses the power of polarizing light, and is usually found in slightly irregular three-sided prisms which, when perfect, are pointed at both ends. It is interesting to note that in heating such a crystal as the tourmaline, it attracts light pith balls to its ends when electrified. If the temperature is kept steady, then no such electrical effects are observed either at high or low temperatures, and again the phenomenon ceases altogether if the crystal is warmed above 150° C. If a heated crystal of tourmaline is suspended by a silk fiber, it will be attracted and repelled by electrified bodies or by a second heated tourmaline. Among other crystals which belong in the pyro-electric family are silicate of zinc, boracite, cane sugar, quartz, tartrate of potash and sulfate of quinine.

Electricity is produced by the disruption and cleavage of certain substances, as for instance, when a sheet of mica is split apart, which action is usually accompanied by the production of a number of sparks, and both laminae are found to be electrified. If sulfur is fused in a glass dish and allowed to cool, it becomes powerfully electrified, which action may be tested by lifting out the crystalline mass with a glass rod. Chocolate is another substance which manifests such an electrification while becoming solidified.

Piezo-Electricity is the term given to that form of electrical energy produced when certain crystals are placed under pressure in a certain direction. With respect to the make-up of the crystal, it was found that if a crystal of calspar was prest between the fingers so as to compress it along the blunt edges of the crystal, that it becomes electrified, and retains its electrical charge for some days. This phenomenon is believed to be due in certain crystals to what is known technically as *skew-symmetry* or *hemihedry* in their molecular structure.

Thermo-electricity: If we take two metal bars, one of bismuth and one of antimony, and join these together, it will be found that an electric current is produced of an appreciable magnitude when the juncture between the metals is heated in the flame of a candle or other source of heat. To demonstrate that there is an electric current produced in all such cases, it is but necessary to connect a sensitive electric current-detecting device, such as a galvanometer to the free ends of the bismuth-antimony couple, as it is called. If all parts of the circuit, including all sections of the bismuth-antimony couple, are at one temperature, there will be no current produced, since the electro-motive forces are in perfect equilibrium. However, when a junction between two such metals is heated, this equilibrium of the electrons and molecules no longer exists, and gives way to the production of an E.M.F. or difference of potential.

(Continued on page 71)

SOURCES OF ELECTRICITY

THE STATIC MACHINE



CONTACT OF DISSIMILAR METALS PRODUCES ELECTRICITY



THE PRIMARY BATTERY

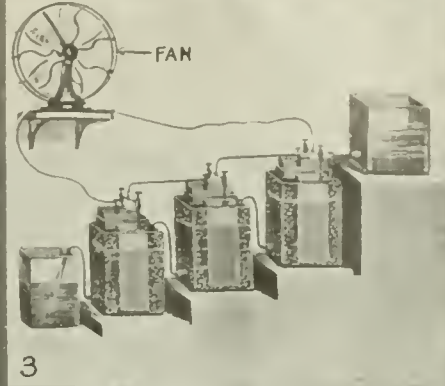

THE GAS BATTERY

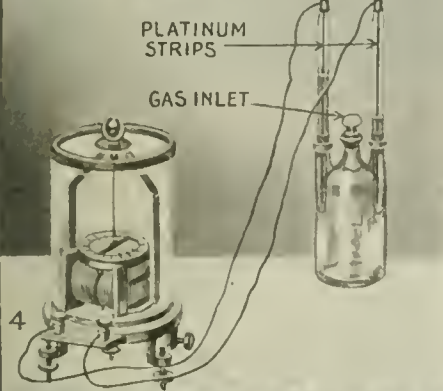

ELECTRICITY FROM CRYSTALS

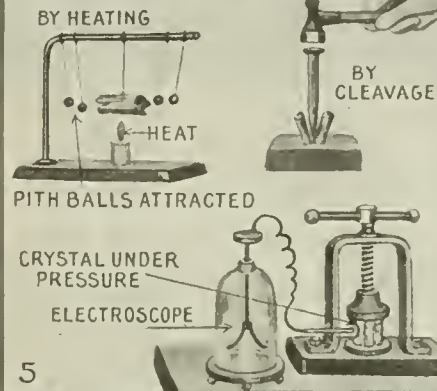

THE THERMOPILE

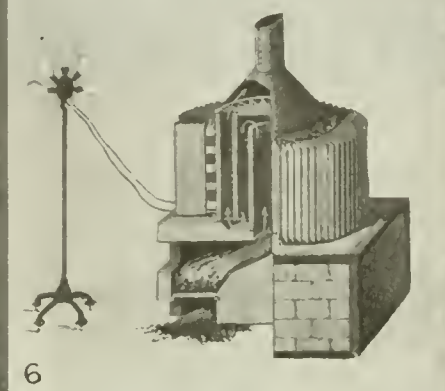

THE DYNAMO

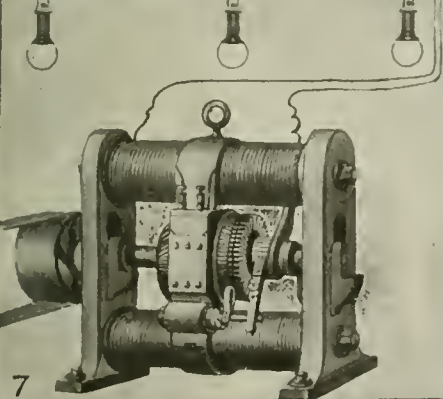

ELECTRICITY DIRECT FROM COAL

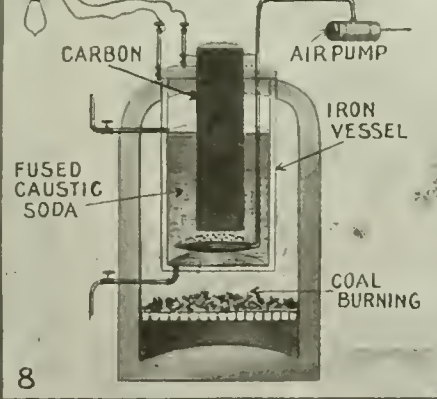

ELECTRIC PLANTS



ELECTRIC FISH



PHOTO-ELECTRIC CELL

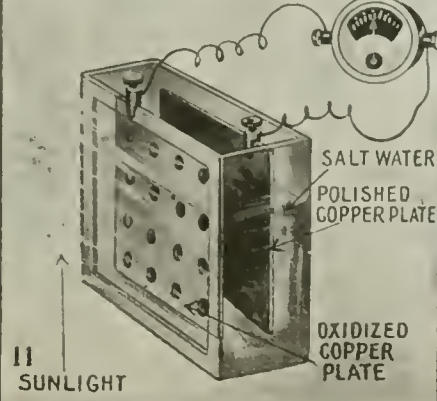

RADIUM ELECTRICALLY ACTIVE



(For description see opposite page.)

Magnetism Produces Remarkable Photographs

BY F. F. MACE

Superintendent of Public Schools, Pecos, Texas

WHAT causes iron, a dense, heavy substance, to ignore or overcome the laws of gravity and to dart thru space to a magnet? What is this mysterious, so called, attraction? Can this swift and sure motion of a heavy body thru space be caused by *lines of force without motion, by lines of tension in ether* or

sistent with the laws of nature, for all the facts of magnetism.

But even this was not sufficient. The facts of nature had been distorted for years. These experiments, conclusive as they were, might be distorted and thrown aside. It must be proven beyond a shadow of doubt in some striking manner that there are actually *currents* about the mag-

net, be such as to effect the photographic plate? I could only try it, as I had tried other things, and hope to obtain the result sought.

The result justified the hope. Taking every precaution known to a photographer to prevent the result being effected by light or other influences I exposed a plate on which were placed a number of objects



Fig. 2. Photograph Taken in Usual Manner, Showing the Various Objects "Magnetographed."

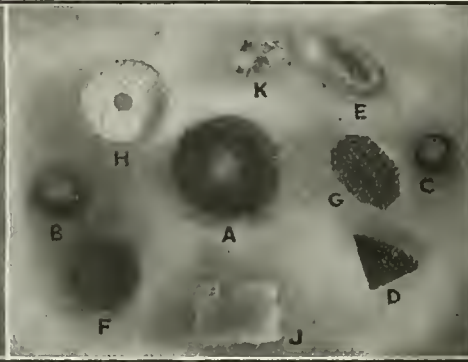

Fig. 3. Here We See the Best "Magnetograph" of the Objects in Fig. 2; It Was Made in a Vacuum.



Fig. 4. Exposure of Photo Plate and Various Objects Placed Over a Magnet Under Atmospheric Pressure. Compare with Fig. 3.

by mere *lines of direction*, like lines of latitude or longitude? Can these lines of force tending or extending, moving without motion from one pole to the other, or lines of force or tension "emerging," without motion, from one pole and "entering," without motion, the other pole, produce the same result at both poles? Can any possible arrangement of the molecules of the magnet, supposing this arrangement to be brought about, possibly extend thru space and accomplish this result? Can any or all of these miracles, these things themselves contradictions of the known laws of nature, bring about another miracle—a result opposing, apparently, one of the laws of nature? Is there a cause for these things in keeping with the known laws of nature?

These questions presented themselves when I first studied physics. They asked themselves more insistently when I began to teach physics, and they have been reiterated again and again in varying form by every class of beginners whom I have appeared before. For more than fifteen years I sought to obtain an answer, a true answer, to these questions—an answer which would really account for the facts and which would be in accord with the other known laws of nature. For years only a faint glimmering of the truth appeared. Then gradually the light grew stronger until I had worked out a clear and logical answer. But to answer these questions by pure logic based on the known facts of nature was not sufficient. Modern science demands experiment; tho Newton and Galileo, and Laplace never performed an experiment but based their discoveries on the facts before them. Therefore, I worked patiently for years to demonstrate in a new way that which I knew to be true, until I had proven by experiment that which I had proven by logical deduction, that the attraction of the magnet and all of the phenomena of magnetism are produced by the motion of *ether currents* about and thru the magnet, and until I was able to demonstrate the cause, nature, and direction of these currents, and by the direction of these currents to account logically, con-

net—that there is *motion*. How could this be done? I had worked with photography for years and was familiar with the X-ray. While pondering this situation the thought occurred to me: will the photographic plate—a photographic plate in a vacuum—prove this? A photographic plate is only affected by motion; by light, which is *ether motion*; by chemical action, which is molecular motion; by heat, which is molecular motion; and by the X-ray, which is in

under an exhausted receiver. At the end of three days I removed and developed the plate. *Images were there, faint but unmistakable.* The experiment was a success! I am sorry that I afterwards dropt and broke this first plate while attempting to handle it during a spell of illness.

With certain success before me I took every precaution to render the result beyond question. In a dark room from which every ray of light was excluded, using only a perfectly safe ruby light, I placed objects on a common photographic plate and placed them under the receiver of an air pump as shown in Fig. 1. These articles are shown in Fig. 2, as they appear when photographed with an ordinary camera. "A" is a lead ring or washer. "B" and "C" are metric weights. "D" is a piece of gasket rubber. "E" is a broken metal buckle. "F" is a bone button. "G" is a scrap of acid-eaten zinc. "H" is a wooden button. "J" is a piece of sealing wax. "K" is a lump of resin. The magnet used is an ordinary steel U-magnet, weighing one kilogram (or 2.2 lbs.). The sensitive side of the plate is above and the objects lie on the sensitive side.

After the objects were placed on the plate under the receiver, twelve thicknesses of black cloth were placed over the receiver and the air was exhausted. Then over all of this was placed a light-tight box and the whole was finally wrapt in ten thicknesses of black cloth. The ruby light was then removed from the room and the room was locked and not reopened for twenty days. I may add that the whole operation took place after nightfall.

At the end of twenty days the room was entered after dark and the plate was taken from the receiver and developed by ruby light as with an ordinary photograph. The result is shown in Fig. 3. The articles are lettered to correspond to Fig. 2. The one marked "D" was lost and is not included in Fig. 2.

Here is incontestable proof that there is *motion*, that there are *currents*, about a magnet. No mere line of force, no tension in ether, no mere line of direction (Continued on page 70)



Fig. 1. How the Author Arranged the Objects to Be Photographed by a Magnet, Placing Them on a Photo Plate Under the Bell of a Vacuum Pump, Permitting the Air to Be Exhausted.

motion. Even granting the ether currents about the magnet as I had proven them to exist, would their wave length, their rate

The Therapy of Light and the New "R-Ray"

By H. ROSENTHAL

THE therapeutic use of light has been known for ages; in fact, it belongs to a period so remote that we are unable to determine even approximately the time of its introduction as a healing agent.

In the far East the earliest writings mention the use of light in the cure of disease, and in the comparatively more recent records of Central American aborigines we

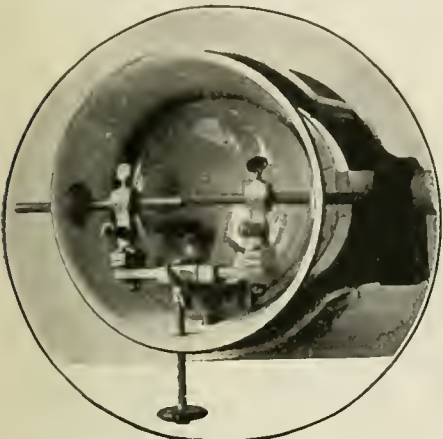

Fig. 1. Appearance of Special Electric Arc Device for Producing the "R-Ray" Radiations, Which Have Proven Extremely Satisfactory in Light Therapy Treatment for Certain Diseases and Ailments.

find accounts of miraculous cures performed by the Sun God. Even at the time of our early pioneers on this continent there are authentic reports of a custom practised by many Indian tribes, who treated wounds and pulmonary afflictions, rheumatism, neuralgia, et cetera, by exposing the naked skin to the mid-day sun, allowing the rays to fall directly on the part afflicted. This custom was in vogue ages before the Spanish Conquest, and was common among the aborigines of America, from Yucatan to the Arctic Sea.

We have, therefore, historic proof that light rays have been used from time immemorial in the treatment of disease, and while modern science and modern methods have attained the same ends, they have not changed the principles known to primitive man—but have merely developed the art.

As light rays are the oldest and most universally accepted therapeutic agent, we naturally ask—how are they translated into terms of therapy by the human body? To which the answer is, thru the medium of vibration and penetrative force of quantity.

Light and electrical radiations are both waves that are projected thru space at the same velocity. They are identical in nature, the one wave length or radiation may differ from another, the same as one sound wave may vary in length from another, as found in the various tones or vibrations of music. Yet all wave lengths, whether light or sound, produce their own corresponding vibrations and we therefore recognize all such vibrations in terms of light or sound.

In further proof of this existing vibratory theory we have color, which in reality exists only in the mind, for color

value is dependent solely upon the number of vibrations impinging upon the retina of the human eye. As for instance when the retina is stimulated by a vibratory force that approximates 400 trillions per second, the impression produced upon the brain is that of the color red; 750 trillion vibrations per second is interpreted by the brain as the color violet. And so on thru the scale of our visible spectrum. Yet, were the human retina sufficiently sensitive to receive and distinguish the many intermediate vibrations, it would perceive, thru the brain countless millions of tints and numerous values that lie between these two extremes.

When these countless millions of tints are all combined we see only white. And tho we perceive and interpret white light as being white, still we know that it is not white, but the combined primary colors and their countless intermediate tints. This fact is easily proved by simply passing a beam of white light thru a prism, which will show the primary colors making up the white beam.

Light vibration without penetration, force or quantity is in itself therapeutically negligible. To have force, it should be direct, and to have penetration the source and quantity should furnish vibrations of practically uninterrupted intensity.

One source of light which fulfills the above conditions is our own sunlight, which penetrates every portion of the human body and exerts a most powerful influence on its economy by oxygenating the blood, generating hemoglobin and producing red corpuscles. And when we become *Sun-Dodgers* we cannot expect any other physical condition than that which takes place in plants under like circumstances, and which entails on human beings the necessity of resorting to other means for making up the deficiency—generally drugs.

Summing up therefore the laws that govern the therapy of light, we find it has the same relation to chemical actions which are governed by the chemic response set up in the substance or tissue, and not by the inherent quality of the ray; while all physical conditions are secured in direct ratio to the penetrative power, quantity and vi-

in a given interval. So that from a therapeutic standpoint it is always highly important to have at our command as great a number of these vibrations as possible; i.e., of the oscillations. It has been avowed by the medical profession that each and every corpuscle and cellular structure in the human body is composed of an infinite number of delicate receivers, each of which respond only when the right *tune* or *vibration* strikes them. Thus when given ma-



Fig. 3. Spectrogram of the New "R-Ray," Showing Clearly its Great Range in the Field of Light Therapy, Extending as it Does Beyond the Visible Spectrum.

major, minor and chromatic scales to operate with, the skilled therapist can compel the vibrations of any cellular structure to respond to those which are produced artificially; and call into action complete therapeutic results, just as in music we call in to play the various gradations of tone and produce perfect harmony.

The period of vibration or oscillations which make up light waves and which the human eye will respond to, are those above the infra-red rays or heat rays and those below the ultra-violet or invisible light rays. The difference between the two is that the vibration of the infra-red is very small and the wave length very long, while those of the ultra-violet region have a tremendous period of vibration and a very short wave length.

The therapeutical work that has been conducted points to the fact that the *ultra-violet rays* are most advantageous and consequently of greatest use in light therapy.

We know that light rays from such sources as the Pinsen, Minin Ultra-violet and X-ray are each capable of exciting a normal, subnormal or abnormal human receiver.

However, our scientists not being satisfied with the belief of the existence of another source of vibration beyond the ultra-violet region, took another step in this direction which proved to be successful, inasmuch as they have found a region between the extremity of the ultra-violet and the beginning of the X-rays. The region is still unexplored, but there is little doubt that the greatest therapeutic secrets lie hidden there.

It is believed that we are only beginning to learn of the real benefits to be gained by the scientific application of light rays by skilled therapists.

The author, who has been engaged in this, as well as the electrical field of research for many years, discovered a new ray which he has christened the R-ray. The production of this new source of (Continued on page 47)

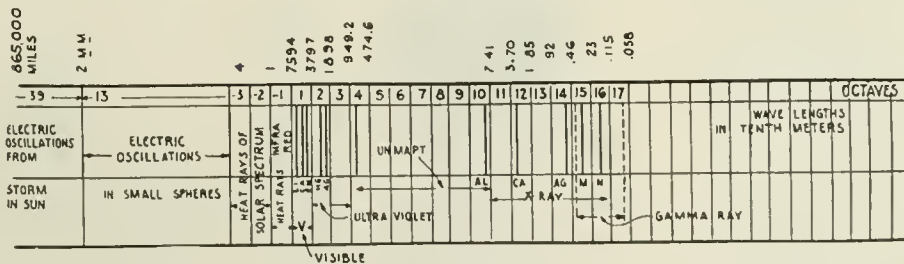

Fig. 2. Chart Showing the Position Occupied by the New "R-Ray" in the Spectrum, Including the Relative Position of the X-Ray Vibrations and Ultra-Violet Rays.

- 4,503,599,627,370,496 = Ultra violet photog. in vacuo
- 789,000,000,000,000 = Violet end of visible spectrum
- 562,949,953,421,312 = Green light
- 451,000,000,000,000 = Red end of spectrum
- 281,474,976,710,656 = Infra-red
- 70,368,744,177,664 = Heat rays of solar spectrum
- 47,000,000,000 = Electric oscillations in small spheres
- Once in 4.7 seconds = Electric oscillations from storm in sun

brating quality of the light employed. All light waves possess two main characteristics that differentiate the effect produced namely: first, the *number* of vibrations in a given interval of time, and second, the *length* of each oscillation or wave

Powerful Electro-Magnets Perform the Work of Many Men

The ordinary work of a man loading pig iron from the ground upon a railway car was from 12 to 13 tons per day. The



The Crucible Steel Company Have in Use at Their Pittsburgh Plant This Gigantic 62-inch Electro-magnet. It Can Lift $4\frac{1}{2}$ Tons of Steel Bars and the Trip of a Switch Releases the Entire Load Instantly. This Class of Work Spells "Economy" in Big Letters and Foundries Everywhere Are Rapidly Awakening to the Fact.

lifting magnet, however, has rendered it unnecessary for this laborious work to be performed by human effort, and the results, as given in the unloading of the steamer, *Erwin L. Fisher*, at Indiana Harbor, Ind., are given in brief below:

With a cargo of 4,000,000 pounds of pig iron, the time required to unload this vessel with twenty-eight men was two days and two nights, which corresponds to about 3,000 pounds per man per hour, or about 15 tons per day of ten hours. When the lifting magnet was introduced, the total time required for unloading was reduced to eleven hours and was done by two men, whose labor consisted in manipulating the controllers in the cages of the cranes. Thus two men and two magnets duplicated the work of twenty-eight men in less than one-fourth the time. Under these conditions the handling capacity of a man and a magnet was nearly one thousand tons in eleven hours, or about 900 tons per day of 10 hours. This is fifty times as much as was accomplished by hand labor, or twenty times as much as is possible even under scientifically managed manual labor. Furthermore, the operation was chargeable with less than one-fourth the overhead charges, while the vessels were enabled to double their number of productive trips.

The lifting magnet has been adapted for the handling of materials in all branches of the iron and steel industry. It is used for handling pig iron, scrap, castings, billets, tubes, rails, plates, crop ends; for loading and unloading cars and vessels, and for handling skull-cracker balls and miscellaneous magnetic material. In fact it seems to be axiomatic that wherever magnetic material, and especially raw material, is to be handled in any considerable quantity, a lifting magnet can be used to advantage and will be a profitable investment.

The accompanying illustration shows in

a marked manner the practical application and efficiency of large electro-magnets used industrially. The first illustration shows a gigantic electro-magnet measuring 62 inches in diameter and swung from a crane at the plant of the Crucible Steel Company at Pittsburgh. This mighty magnet has been photographed in the act of lifting 17 steel billets, each weighing 575 lbs., or a total of 8,925. It takes but a moment's reflection to readily conceive just how much man-power would be required to move this same weight of steel, not to mention the time occupied in moving it. A single operator, in this case the man operating the crane, lowers the magnet onto the steel bars and when in contact or nearly so, he closes the switch supplying the magnet with electric current. The magnet instantly becomes alive and exerts several tons of magnetic tractive power and holds the billets to its face securely, as pictured in the illustration. The crane may swing along for several hundred feet, carrying its suspended load, and as soon as it reaches the desired location the magnet is lowered; when the operator opens the switch the magnet instantly releases its $4\frac{1}{2}$ tons of steel.

The second illustration shows a powerful electro-magnet at work in the yards of the Chicago, Milwaukee and St. Paul Railroad's West Milwaukee shop, the magnet measuring 43 inches in diameter and lifting in this case a locomotive drive wheel. The lifting magnet is an attractive proposition to-day and not only appeals in large sizes but in the very small sizes as well. The small hand type electro-magnet is particularly efficacious for picking up quantities of iron nails, screws, etc., in hardware stores and stock rooms and finds application in a thousand and one different ways daily.

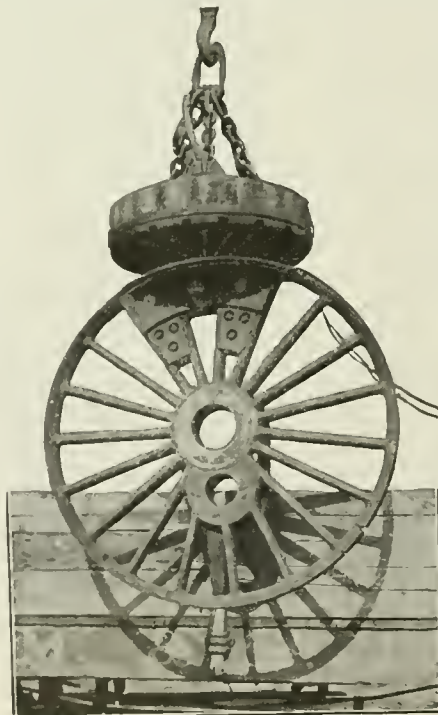

43-inch Magnet Lifting a Locomotive Drive Wheel at the West Milwaukee Shop of the C. M. & St. Paul Railway. Another Instance of What the Lifting Magnet Is Capable of Doing.

THE ELECTRIC HEATER FOR THE KITCHEN BOILER.

The accompanying semi-sectional view of an ordinary kitchen boiler shows how a recently perfected electric water heater is attached to it. This heater heats the water before you turn the faucet and not—some time afterward. The tank is always charged with scalding water at any temperature you wish up to 200° F. (212° F. boiling point), or enough heat for about five baths—always on tap.

The heater has six steps—and the regulator is a six-point current control. When no water is being drawn the heater will probably be cut entirely out so that no electricity is being used. Then as some water is drawn the regulator picks out that step of the heater which will pump back into the boiler the same amount of heat that is drawn from the faucet in the hot water. At the sixth step the regulator applies two full horsepower, storing heat at 100% efficiency. It is claimed that this particular electric water heater will operate on 15 to 20 per cent less energy than the circulation type heater, for the same monthly gallon production.

The present heater has been specially designed to make it self-cleaning. Under the intermittent operation of the thermal control there appears a slight but constant opening and closing of the split heating tube, which readily cracks off all scale and any precipitate forming on the tube. This deposit accumulating at the base of the heater is then easily flushed out of the full size $1\frac{1}{4}$ -inch drain. This self-cleaning feature is, perhaps, next to efficiency in importance to the housewife to whom a burned-out heater means not only needless expense but several days' interruption in the hot water service and a recent engineering report gives the external circulation type water heater four months in which to become absolutely choked with scale.

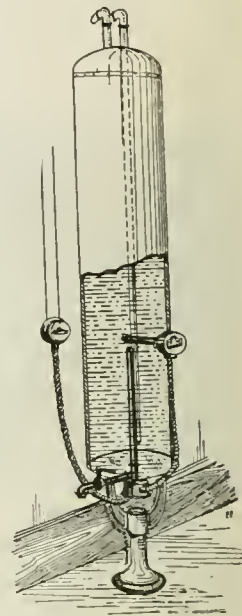

An Electric Heating Unit That Fits the Kitchen Boiler.

CAN SINK SUBMARINES BY WIRELESS, SAYS INVENTOR.

Theodore Eichholz, a young engineer and architect of Pittsburgh, has invented a wireless device that may be used to destroy submarines by causing an explosion of gases that are always present in submarines, he claims. For several years the inventor was connected with the United States Corps of Engineers.

Mr. Eichholz stated that just recently a small experimental apparatus in his home on Neville Island sunk a small "dummy" submarine in the Ohio River, five miles away. The destroyed model was of steel and submerged to a depth of ten feet.

All submarines while under water are propelled by electric storage batteries which throw off a gas that pervades the hull. This gas, Eichholz says, he detonates by the wireless current and destruction follows. The apparatus will be submitted to the U.S. Government at once.

NOVEL TELEGRAPH INSTRUMENT THAT RESPONDS TO VOICE.

Strange as the title may seem, yet the successful operation of such a device has been accomplished thru the researches of Mr. Christian Berger of New York City.

The accompanying photograph shows the complete equipment of the electric voice-operated telegraph instrument. The operation of the device is not attained by the employment of a microphone of any kind, but by means of a sensitive sound-operated circuit-breaker, which controls a special relay and which in turn operates electrically either a sounder or recording instrument. The circuit-breaker is placed in a metal box which is seen in the center background of the photograph. This consists of a bent wire, properly balanced on an insulating block. The end of this wire presses lightly against the side of the box, which makes a permanent contact when it is not disturbed. The second connection is made thru the metal box and this is terminated with one binding post of a battery, while the bent wire is connected to one side of the relay electro-magnet, the opposite side being linked to the other binding post of the battery. The electro-magnet actuates an armature which controls a cog-wheel by means of a projecting strip on the armature. On the same shaft with the cog-wheel is a drum upon which a number of contacts are secured. These are alternately connected, so that one will complete the electrical circuit when desired and when moved to the next stud, the circuit will be opened. It is built on the lines of a step-by-step relay, which has been used some years ago for controlling moving vessels by radio waves. The drum circuit and the horizontal brushes which touch the drum studs, are connected in series with the recording instrument and battery.

The operation of the apparatus is exceedingly simple as one must only be familiar with the telegraph code, but not experienced in handling a telegraph key, as the transmitting is done by calling out the dot and dashes to the instrument. When a signal is made the sensitive sound actuated circuit-breaker opens the circuit which causes the armature of the relay to release it, thus giving a rotary motion to the cogwheel and in turn closing the recording instrument circuit. The complete equipment is very interesting when in action and possesses many diversified possibilities.

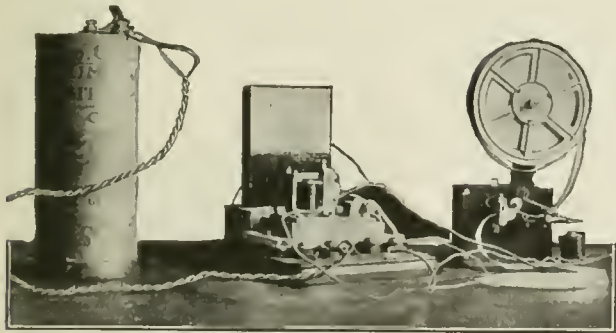

Speak to This Telegraphic Novelty and It Records the Equivalent Dots and Dashes on a Paper Tape.

ICELAND'S ELECTRICAL PAPER.

Elektron is the name of an electrical magazine published monthly at Reykjavik, Iceland. The leading article is on the Icelandic telegraphs and telephones, by Mr. Gisli J. Olafsen, who visited this country a year or more ago and studied American telegraph and telephone methods. This article is printed in the Danish and English languages.

LOS ANGELES HAS WONDERFUL ELECTRIC FIRE TRUCK.

THE electric equipment of a new fire-fighting apparatus recently built by the Los Angeles fire department has no equal in the country. This equipment is mounted on a ton and a half motor truck

As a precaution against any one accidentally touching the foot throttle and speeding up the engine to too great a speed, when the wagon is standing at a fire, a special protective device has been provided, which consists of a hood which can be lowered and locked in a position, completely protecting the foot throttle from the curious.

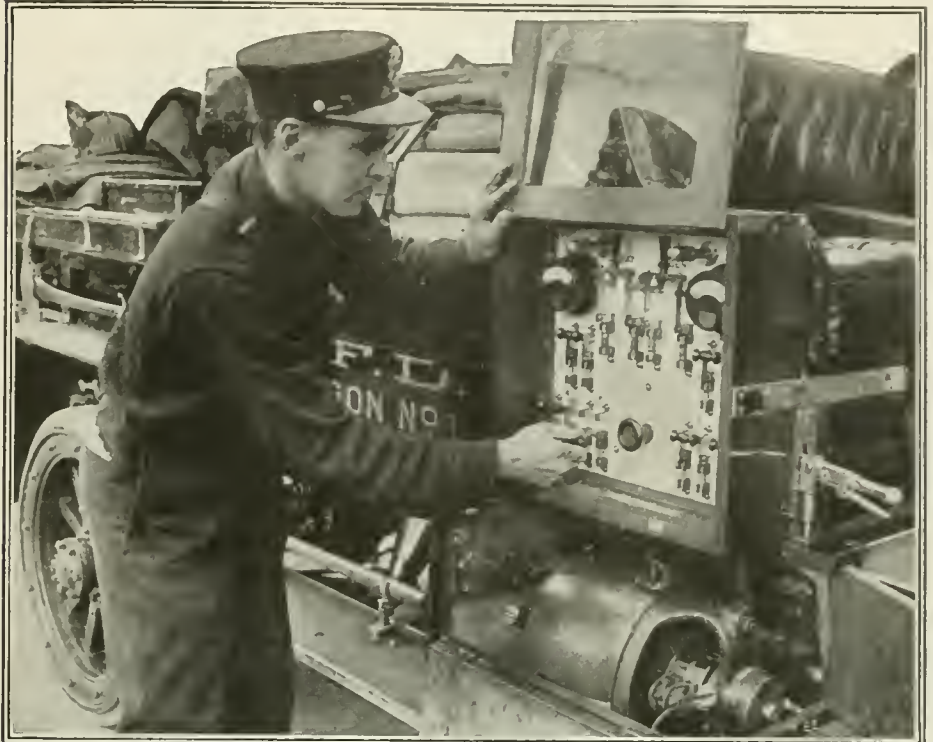

Los Angeles, Cal., Boasts of Having One of the Most Complete Electric Fire-fighting Trucks in the United States. The Equipment Comprises Five Powerful Searchlights Which are Supplied with Power from Either a Large Storage Battery or the Dynamo Shown in the Picture.

and was both designed and built by members of the fire department.

The equipment consists of five powerful searchlights, each rated at 250 watts, capable of throwing a brilliant beam of light over 500 feet away. At this distance work at a fire can be carried on with great efficiency. Yet these lights are so arranged with diffusing lenses that it does not blind the firemen, even a few feet away.

The lights are 16 inches in diameter.

Three are permanent and two are portable, each being attached to 320 feet of heavily insulated cable wound on a reel which can be unrolled, permitting the lights to be carried this distance into a burning building.

The handicap of a strange and smoky building is overcome by the use of these portable lights. They will penetrate smoke to almost an unbelievable distance, permitting the firemen to fight fires thru dense smoke with the greatest of ease.

Power is received from eight large storage batteries placed behind the seat. These batteries themselves are capable of furnishing current for the lights for seven hours. Also installed on the right foot-board is a generator of 50 amperes, 25 volts, 1.25 K.W. This is run by a silent chain drive off the main propeller shaft and is controlled by a separate clutch, shown in front of the switchboard seen in the photo. The generator may be cut in or out at will, by means of this clutch.

A perfectly equipped switchboard is mounted on the right side immediately above the generator, having a marble back in an enclosed case with a glass front. It is equipped with a master switch for both the batteries and generators. Also an individual switch for each light and gages to show amperes and volts, a resistance cut-out and small lights to illuminate the board. Fuses of proper capacity are installed for each switch. To prevent damage to generator or batteries an under-load and an over-load switch is installed. This acts as a governor, the purpose of which is to automatically disengage the charging line from the generator when the rate of charge reaches a dangerous value or when the rate of charge is so low that there would be danger of the batteries bleeding.

The portable lights are adapted to be used on a tripod. They are mounted on the wagon on a swivel connection with a one-inch diameter stem projecting, which fits into a socket fastened with a nut. A similar socket is provided on the tripod and when the light is set on the tripod, a large hand nut is provided which holds it securely. The light mounted on the tripod can be readily moved from place to place by one man. As he carries the light to the fire the reel automatically unwinds.

A wireless telegraph distance record of 11,500 miles was established by the steamer *Sonoma*, which picked up messages from Eilvese, Germany, when two days off Australia, according to Royden Thomberg and Clio Bowers, operators on the *Sonoma*. Ellery Stone, assistant United States radio inspector at San Francisco, said it was the greatest distance achievement in wireless telegraphy.

MONSTER MOTOR GREATEST EVER BUILT.

We are told that at one time this old world of ours was inhabited by gigantic monsters. Well, we still have monsters—mechanical ones—that are far more powerful than any of which our ancestors

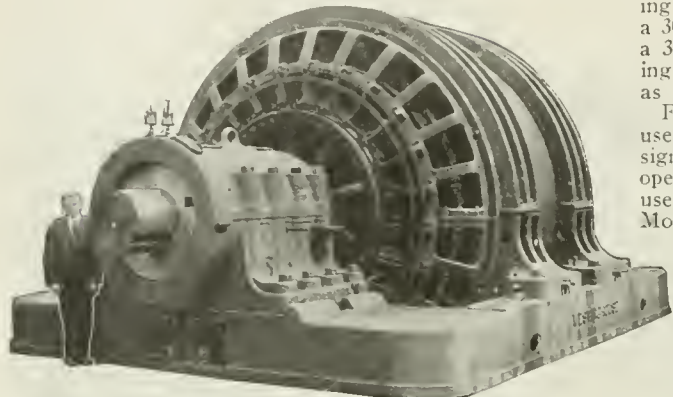

The Egyptians Built the Pyramids—but See How Modern Man Builds an Electric Motor Developing the Combined Power of 15,000 Horses. This Is the Largest Motor Ever Built.

knew. Take, for instance, the mastodonic Westinghouse reversing motor here shown, which was specially designed for driving 35-inch reversing blooming mills in large steel plants. When we realize that it has a capacity of 15,000 horsepower, the largest electric motor ever built, we need no further proof—we know it is monstrous. Some idea of its size may be gained when it is stated that the man standing alongside the motor is six feet tall.

ELECTRIC LIGHTS CHEAPER THAN KEROSENE.

How much cheaper are gas mantles and electric bulbs than candles? The Society for Electrical Development, anxious to encourage a wider use of electricity for lighting, has prepared figures showing that both are much cheaper than candles or kerosene, and that electric light, while it is more expensive than light from a gas mantle, is much cheaper than light from an open gas flame.

A recent test of six candles showed that for one cent only 2.68 candle-power hours were obtained. If electricity for lighting costs nine cents for a kilowatt-hour a 20-watt lamp can be lighted for 50 hours for nine cents. The efficiency of a 20-watt incandescent is a candle-power for 1.17 watts. Thus a 20-watt lamp will provide about 17 candle-power. It will burn 50 hours for nine cents or 850 candle-power hours will cost nine cents. One cent will buy 94.4 candle-power hours, or 35 times as much light as can be obtained from a candle for one cent.

Ordinary kerosene lamps with kerosene at 15 cents will give 72 candlepower hours for one cent. Figuring electricity at nine cents a kilowatt hour as above, we find 72 candle-power hours for one cent balanced against 94 for electricity, or a margin of 22 candle-power hours in favor of electricity. With an open gas flame and gas costing 85 cents a thousand cubic feet, one cent will buy 51 candle-power hours. For this price electricity will provide 94 candle-power hours. Thus balancing gas against electricity, we find the margin to be 43 in favor of electricity. Gas mantles have become very popular and with best mantles one cent will buy 201 candle-power hours.

TRAVELING ELECTRIC SIGN FOR SHOW-WINDOWS.

The traveling electric sign here illustrated is a new moving feature sign for window attraction that can be operated where heretofore the ordinary signs have been used. It displays the same amount of reading that ordinarily requires a 30-ft. length of space into a 3½-ft. space. The wording can be changed as often as desired.

Four 10-watt lamps are used for illuminating the sign, and the motor which operates the moving band uses only about 20 watts. Motor and lamps together use about the same amount of current as a 32-c.p. lamp. During the daytime, when the motor only is working, it uses less than one-half as much and the sign is equally effective.

Any length of film from 6 ft. to 30 ft. can be used and changed in a few minutes.

This sign can be operated on either 100 to 120 volts direct current or 100 to 120 volts (60 cycle or less) alternating current by changing the connections at the terminal board.

The sign comes complete, ready for use,

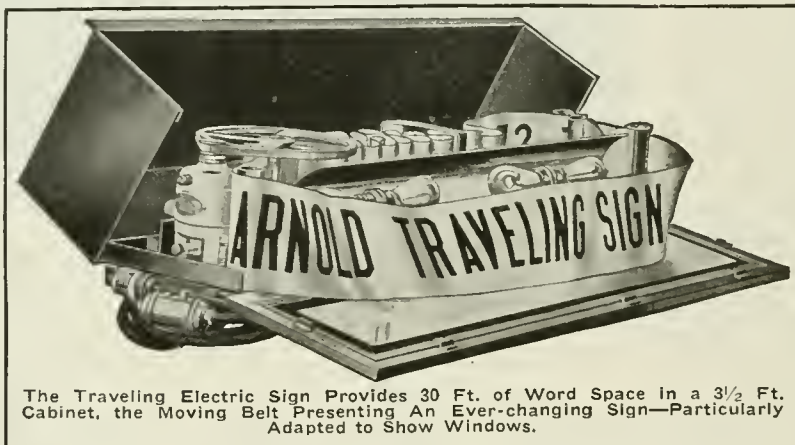

The Traveling Electric Sign Provides 30 Ft. of Word Space in a 3½ Ft. Cabinet, the Moving Belt Presenting an Ever-changing Sign—Particularly Adapted to Show Windows.

and can be operated from any convenient lamp socket. It can be set anywhere, or suspended with cords to hang at the top, middle or back of any show window.

MUNICIPAL TROLLEY OF SEATTLE LOSES MONEY.

The municipal street railways of Seattle, Wash., continue to lose money, as shown by the report of A. L. Valentine, superintendent of public utilities, in his report for October, the net loss being about \$2,000 monthly. Since the city light department took over the street railway substations the power cost is being checked against the value of the substations, so that in October the street railways received \$1,069 worth of power without cash outlay.

SAYS U.S. SHIPS HAVE GREATEST RADIO RANGE.

After he had inspected radio apparatus on a number of vessels recently, Secretary Redfield of the Department of Commerce said that American vessels have a wider range in sending and receiving messages than ships of other countries. He also asserted that, from a comparison which he made of apparatus on an American and a British steamer, the wireless regulations past by Congress give greater power to radio inspectors than do British regulations.

NEW VACUUM BULB RECTIFIER FOR BATTERY CHARGING.

The latest novelty in small rectifiers for charging storage batteries rated at 2 to 6 amperes charging rate and from 7.5 to 75 volts is here illustrated. It operates on a new principle for this class of apparatus. The discovery that made it possible is the perfection of the small bulb similar to that of an incandescent lamp, in which rectification of the current takes place. This bulb is filled with an inert gas and contains a tungsten filament and a graphite anode. It screws into a lamp socket in the outfit.

A black-japanned casing with perforated top furnishes the mounting and incloses all live parts. This casing carries the bulb, a fuse to protect against reversal and other overload and the compensator which reduces the alternating current without wasteful resistance and excites the tungsten filament. For charging, the rectifiers need only be connected to a convenient lamp socket and the pair of leads attached to the proper posts on the battery.

The smallest unit is of 2 amp. maximum capacity. From a 115 volt, 60 cycle alternating current circuit it will charge three lead battery cells at 2 amp., six cells at about 1 amp., and eight cells at 0.75 amp. Between these figures the charging rate is proportionate. At 10 cents the kilowatt hour for current, the cost is about 1 cent the hour, including tube renewal costs. The weight is about 15 lbs. Medium size rectifiers have a capacity of 6 amp., 7.5 to 15

volts, and are designed primarily for charging three or six-cell automobile starting or lighting batteries in home garages. This type is designed for 115 volts, 60-cycle current, but may be used on 105- to 125-volt circuits. The weight is about 15 lbs. The largest type is designed for use in public garages and service stations, and has a capacity of 6 amp., 7.5 to 75 volts. It will charge from one to ten three-cell storage batteries from a 115-volt, 60-cycle, alternating-current circuit. A compensator with fifteen taps is part of the device and a dial switch for instantly adjusting voltage according to the number of batteries to be charged. Amperage can be regulated between limits of 1 and 6 amp. A single

three-cell battery may be charged by itself or any number up to and including thirty cells. The controlling devices, including ammeter, switch and regulating handle, are located on the front of the case as seen.

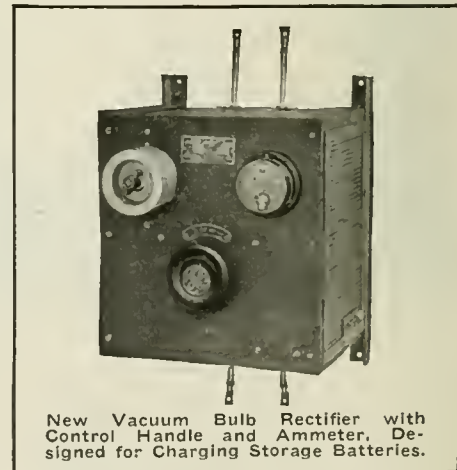

New Vacuum Bulb Rectifier with Control Handle and Ammeter, Designed for Charging Storage Batteries.

CIVIC FORUM MEDAL FOR DR. BELL.

Dr. Alexander Graham Bell, inventor of the telephone, before a gathering which filled Carnegie Hall, received the Civic Forum Medal of Honor for Distinguished Public Service on March twenty-first. This medal was presented in 1914 to Major-general George W. Goethals and in 1915 to Thomas Alva Edison. After many eloquent speeches in his praise, Dr. Bell responded modestly, endeavoring to share the tributes to him with those who have been associated with him in developing the telephone.

"I may perhaps claim the credit of blazing the trail," he said, "but I am embarrassed at all the honor which has been done me, because so much of it should go to the many men who have since improved upon and extended its use—to such men as Mr. Carty and his associates. Why, I am not even able to understand some of the mechanism which they have introduced into the use of the telephone. When they telephoned from Arlington and were heard at Eiffel Tower in Paris, I could not see how it was done, nor could I understand how an operator in Hawaii was able to pick up the message."

Dr. Bell told how, shortly after he got the idea of the telephone in 1874, he had called on Professor Henry at the Smithsonian Institution, who was then recognized as the greatest authority on electricity in America. Professor Henry listened kindly to his plan, and told him that he thought he had the germ of a great invention.

"I told him that the trouble was that I did not have enough knowledge of electricity," said Dr. Bell. "He said, 'Get it.' Now the fact is that, had I known much about electricity, I would never have invented the telephone. I would have thrown up the idea as wildly improbable. My study had been that of sound."

A NEW INSULATING MATERIAL.

"Galalith" is a hone-like substance similar in many respects to celluloid. It is manufactured from casein and formaldehyde. A solution of casein is obtained by treating skimmed milk with caustic alkali, after which the solution is clarified and the casein then precipitated by means of acids and filtered. The water is then extracted under pressure and the product slowly dried over a period extending several weeks. The product obtained is casein plate, which is treated by thoro saturation with formaldehyde and dried again. Galalith is said to be an excellent insulating material somewhat transparent, altho never completely so, and of a yellowish-white horn-like color. It is workable either in the hot or cold state, the cold galalith being softened by treatment in hot water. It is odorless, and much less inflammable than celluloid. It cannot be made into very thin sheets.

Senator Sheppard recently introduced an amendment to the naval appropriation bill calling for \$50,000 to be expended in the erection of a radio station at Galveston.

HEINRICH HERTZ.
Born Feb. 22, 1857. Died Jan. 1, 1899.
Inventor of Wireless.

HEINRICH HERTZ was born on February 22, 1857, in Hamburg, Germany. He received his early training in the engineering schools but at the age of twenty-one he decided upon an academic career



Heinrich Rudolph Hertz—Father of the Wireless Telegraph. Upon His Scientific Researches and Practical Demonstration of Maxwell's Electromagnetic Theory, Marconi and Others Have Built Up the Commercial System We Know To-Day.

and entered the University of Berlin as a pupil of Von Helmholtz and Kirchoff.

Of the many gifted students of physics who have come forth from the celebrated

tem proposed by the Berlin Academy of Sciences in 1879.

From 1880 to 1883 Dr. Hertz was an assistant in Von Helmholtz's laboratory; he then lectured for two years as instructor at Kiel. From 1885 to 1889, he was professor of physics in the Polytechnische of Karlsruhe. In the latter year Clausius, a professor of this institution, died, and Hertz was selected as his successor in the University of Bonn, where he spent the few remaining years of his life.

Hertz's career as a scientific investigator covered a period of scarcely more than ten years, during which time he published thirty-six papers. Of these, a series of thirteen which appeared in Wiedemann's Annalen, were upon the subject with which his name will forever be connected, *the laws of the propagation of electro-magnetic induction thru space*. Of this great work, which afforded a complete experimental verification of the Maxwellian theories concerning electro-magnetism and the relation of electricity to light, there is no need to speak of its great importance to the scientific world.

The importance of Hertz's contributions to this great subject received instant recognition. It would indeed be difficult to find any other instance in which researches bearing upon a most subtle and difficult question, and absolutely devoid of basic elements of a utilitarian or even of a popular character, having secured to their author such sudden fame. In addition to the recognition of those who were able to appreciate his work, Hertz received the acclamations of the entire world of thought. Fortunately, he possessed a nature of such complete simple-mindedness that his sudden rise into a position akin to notoriety had no effect upon him. The unassuming bearing which had always characterized him remained with him to the end.

In delightful harmony with the genuine and simple nature of the man were his surroundings in the quiet university town of Bonn. His laboratory was situated in the apartments formerly occupied as a dwelling by Clausius in a wing of the old palace. Since electricity has become utilitarian, we find it associated everywhere with moving machinery and with the rush and bustle of modern industrial life, but in Hertz's laboratory, there was nothing to suggest the science of electro-technics. The place seemed to breathe that spirit of academic repose which to the inmates of the present day must have seemed to have vanished altogether from the world. What might such a man, in such an environment, have not been able to achieve, had he lived?

The promulgation of the theories of Dr. Heinrich Hertz in connection with *Wireless waves*, stimulated universal interest all over the world, which led to their use in the propagation of intelligence thru free space.

In 1892, Hertz's researches upon the electric waves were gathered together in a volume under the title "Untersuchungen ueber die Ausbreitung der Elektrischen Kraft." Almost on the day of his death, another excellent translation of Hertz's researches appeared.

TO ALL RADIO AMATEURS.

THE Department of Commerce of Washington, by its Secretary, the Hon. Wm. C. Redfield, has kindly sent us the following information of particular interest to all amateurs in the United States at the present time.

Secretary Redfield has issued orders that for the present no new licenses to radio amateurs will be issued and the renewal of outstanding amateur licenses will be granted only by the Department upon special favorable reports by the radio inspectors. (This refers to sending outfits only.)

The Department also informs our readers, reminding them of the fact that the operation of transmitting radio instruments without licenses is prohibited under severe penalties, which, under the conditions of the time, would be exacted in the case of those who showed no regard for the requirements of the law.

Up to the time that we go to press, the Department has not formulated final plans as to what steps will be taken in regard to radio amateurs as a whole, and whether they will be allowed to continue to operate the same as before. It is our personal impression, however, that no drastic steps are likely to be taken by the Government as long as the amateurs cooperate with the Department.

In view of this we most urgently and earnestly request all amateurs at the present time to refrain from using their transmitting stations except for regular work. In other words, all unnecessary gossip and fooling should be rigidly suspended for the present, particularly the "Q.R.M." nuisance which at best, only serves to irritate our officials, and makes their work harder. If amateurs do not voluntarily stop such annoyance the Government will certainly prohibit the use of all privately owned radio outfits.

These are no times to use the ether for a lot of nonsense; we all wish to help our country as much as we possibly can until normal conditions are restored again.

Always remember, that our Government has granted the radio amateurs more powers than any other country in the world, and in times of stress, it is up to the amateurs to show of what stuff they are made by cooperating with our officials to the fullest extent of their powers.

THE EDITOR.

Berlin laboratory, there are probably none who have become so world-famous as Heinrich Hertz. His qualities as an investigator were speedily recognized by Von Helmholtz, who urged him while still a student, to undertake the solution of the prize prob-

"Eddy Currents"

By C. M. ADAMS

LIEUTENANT Commander Parker, U.S. submarine 'F-609.' Our torpedoes useless. Proceed at once and see if you can do anything. Enemy's defense perfect. Admiral Gregg, U.S.N., Commanding Flotilla."

I glanced up from reading this message, scrawled on a scrap of paper, to ask Parker what it meant, but he was not there. I heard him in the forward compartment issuing orders in his rapid-fire manner.

It puzzled me, this brief dispatch which Parker had translated from the muddle of code words that had come in over my wireless. Could it be that the great fleet of submarines now in mid-Atlantic, supposed to be torpedoing the enemy's fleet

we went out, thirty-two knots an hour, headed for the open sea.

As we went I picked up a message with my wireless which seemed to be related to the information in the code message Billy had received. It was a press dispatch and read:

"There is a report that the defensive submarine flotilla which was to meet the imperial fleet in mid-ocean, is helpless because of the excellent defense of the imperial fleet against torpedo attack. The report says that the submarines have discharged every torpedo aboard and have not damaged a single enemy ship.

"The imperial fleet was reported by aero-scouts to be of sixteen battleships, together with eight destroyers and followed

by our navy with its present equipment. How could we save our country from the invader? How could we stay off the defeat which seemed imminent when that wonderfully trained army got into action against our meager forces?

I voiced these sentiments when, about nine o'clock I found Billy standing beside the conning tower on the open deck, looking forward over the double wave that marked our bows.

I felt free to ask Billy Parker much, for we had been old classmates at the Tech. school before he went into his electrical engineering work and I drifted off into mine, not seeing each other until I dropt into this craft as its wireless operator when the call came to me from the navy.

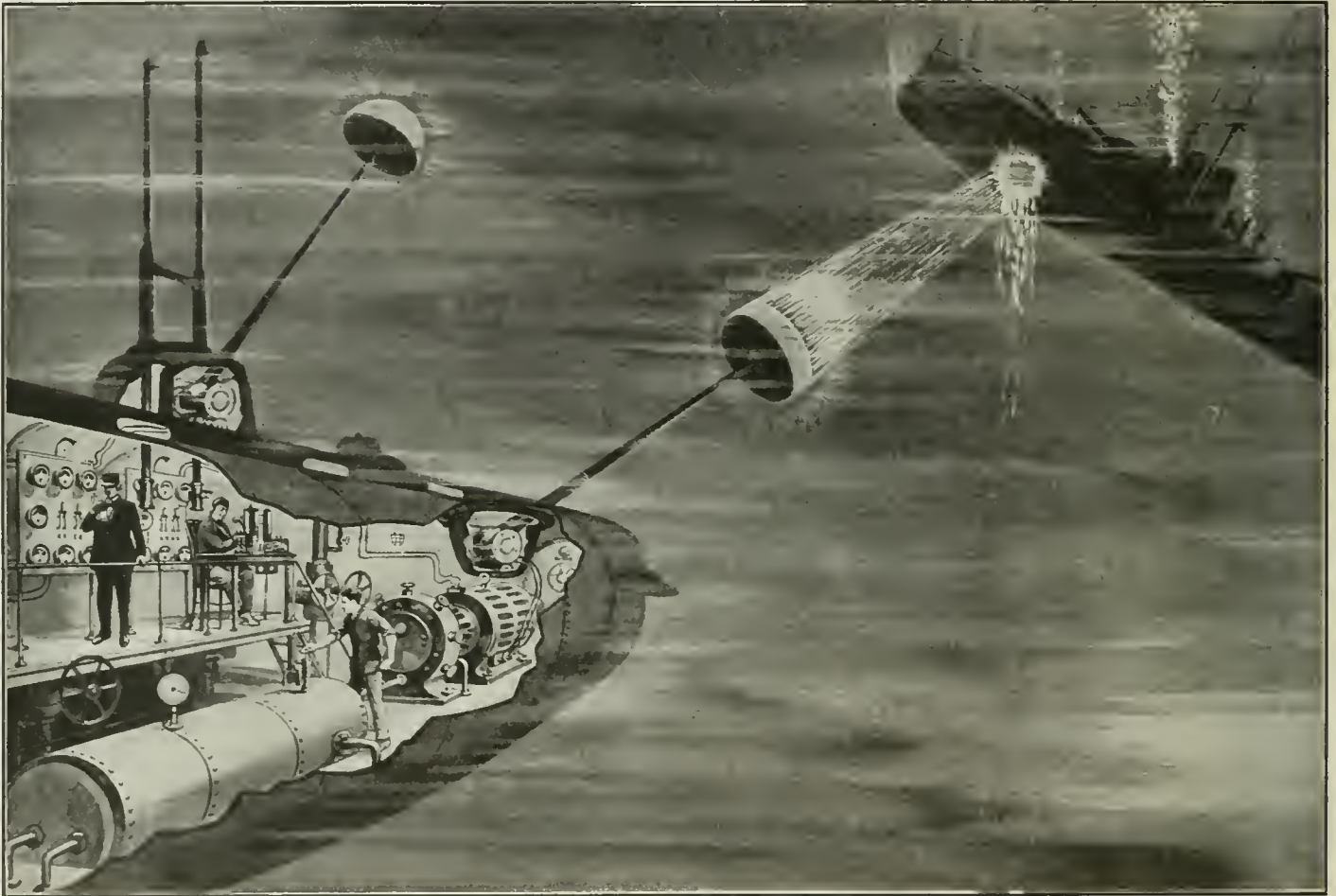

Once Again He Called to Start the Alternator. The Hum of the Machine Sounded and as Before the Switch Was Deprest. I Timed It Now and Found That It Was Held Down Six and a Half Minutes.

as it tried to approach our shores, had failed in its mission? Were the new powerful torpedoes, loaded with hundreds of pounds of high explosive, and the great mechanical fish which launched them, useless as far as defense was concerned? I wanted to ask Billy Parker these and many other questions but he was busy.

An hour after this message had come buzzing in we cast off our moorings and were slipping out thru the harbor dotted with hurrying navy craft. We did not attract any unusual attention, for submarines were quite common sights in these times. Soon we past Sandy Hook, thru the line of patrolling cruisers, then out into the open sea. Our turbines were purring smoothly and our driving motors were spinning like great smooth-running tops as

by twenty transports carrying the invading army. There are also several enemy aeroplanes which accompany the enemy fleet."

Evidently something was wrong with the defense planned by the navy officials. The fifty great under-sea craft were not doing their duty, which had been to sink as many of the invader's ships as possible. I puzzled over this as I sat about waiting for my call and wondered what we would do now that our chief defense had gone.

What would happen when the army in those twenty transports landed on our shore, unprotected save by the scanty coast defense guns, made scantier by the appropriation for submarines, and met our volunteer army in a pitched battle? This truly was a surprise, an overwhelming, unexpected contingency which could not be met

Wireless operator was all I was good for, owing to my lame leg.

"What will happen now that our submarines are helpless?" I asked.

"It's up to the coast defense and the fleet if we can't stop them," he said, looking away ahead where the sea rolled under the faint stars.

Billy confided in me. His showing me the translated code message proved that. But this was a new turn.

"If we can't stop them?" I repeated blankly.

It had not occurred to me that we were going to try to stop them at all. I did not know why we were going, but it seemed obviously impossible for us to do anything in that direction when the rest of the submarines had failed.

"Yes, if we can't stop them," he repeated after me.

"Why, we won't be any better than the rest of them. That torpedo defense is too good," I argued.

"Who said anything about torpedoes at all?" he demanded, wheeling and staring at me aggressively.

"Well, we're only a submarine," I retorted.

"Does that mean that we necessarily have to use torpedoes?" he countered.

"Why, don't we?" I asked.

"We haven't a thing that resembles a torpedo on this boat except the shells for that three-inch gun under the deck, and they will be about as effective against a battleship as birdshot against an elephant."

I stared at him a long time then. He was serious as I could see, even in the starlight, but he was not lucid.

"Well, how are we going to get them then?" I asked, thinking that this natural question was expected of me.

"I'll show you," he answered, and stepped down the ladder leading below.

I made to follow.

"No, stay there," he commanded.

I did, leaning against the steel conning tower. A moment later I heard the sound of mechanism close to my head and glancing up I saw something appear above the conning tower. I climbed upon the low rail and looked up to see what it was.

The steel plates had opened in the center and from the opening had emerged a hemispherical object, made of what appeared to be very heavy glass and measuring about three feet in diameter. Inside it was what looked to be a small mechanical device which seemed to run on a small circular track.

I was busy examining the device when I heard Parker beside me.

"That," he said, "is the *Feeler*."

"The *feeler*?" I repeated, this was new to me.

"Yes, the *feeler*, a device that will locate any ship within ten thousand yards, without any part of our boat being seen."

I looked at the device again with increased interest. I could not see anything distinctive about it.

"Don't you see how it works?" Parker asked.

"No, I can't say that I do," I admitted.

"Come on down in the control room and I'll show you."

He led the way down the ladder and we went into the little box of a room under the conning tower where one is afraid to lean against the wall for fear of starting or stopping something necessary to the life of the boat.

He picked out a glass case from among the litter of instruments on the walls and pointed it out to me. It was not a very big case. In it were three dials, an electric lamp and below it were three small control wheels. It looked very much like the other dials and wheels so thick about me, and was distinguished only by the word "*Feeler*" on the case.

"This device," he said, "works on the principle of electro-magnetic induction. You know what that is, the setting up of a current in something that cuts the field of force caused by a magnet. Well, up there in that glass case which will stand any pressure the boat hull will, is a mag-

netic coil mounted on a revolving and inclined carrier. This coil is shaped and wound so that its lines of force are kept within a very small area, in this case about one and three tenths square feet. Consequently when a metal object passes thru this relatively intense field, the induced current in the metal object will be sufficient

the coils clear of the conning tower."

I saw then the whole perfect simplicity and accuracy of the device. I marveled at it.

"Then you can run under water without even a periscope exposed and locate the exact position of the enemy," I said.

"Exactly, you understand it perfectly," he replied.

"Then you can aim your torpedo with accuracy," I went on.

"Torpedo!" he snorted with an exasperated frown. "Didn't I tell you that we didn't have one of those antiquated devices aboard this craft?"

"But," I went on, "you must have something to sink the enemy after locating him."

"We have," he said, his face brightening hopefully.

"Well, what is it?" I asked, puzzled.

"Look here, Dick Hartman," he said in mock seriousness, "do you mean to tell me that after seeing this *feeler* work, you can't understand how we could sink a ship? You, a graduate of the best technical school in the country and a practical electrical engineer, can't understand that?"

I confess that I did not.

"Then you're either asleep or haven't the least trace of imagination," he said, turning away in disgust.

"Well, how do you do it anyhow?" I asked.

"I'm not going to tell you. I'll let you find out for yourself first," he retorted with a show of his old boyish perversity, and walked into his room and left me wondering in front of the *feeler* dial.

But I could not follow his line of reasoning to its end. I thought of it as I tried to sleep that night, while the motors thrust us forward and our long hull swayed gently as we topt the crests and fell into the hollows. I puzzled over it as I sat at my instruments and waited for my call, or anything else my receivers could pick from the ethereal vibrations about us. But I could make nothing of it. I could see no way, no means by which we could sink an enemy ship with this curious little *feeler* device which with all, was exactly accurate.

All that night we ran and all the next day. I did not ask Billy any more about our boat. Pride perhaps kept me from doing this, and impatience at my own lack of perspicuity and imagination. And then too I was busy with my own work and other things that came up, which had to be done in the crowded under-sea craft.

I prowled about it in what spare time I had, trying to see what I could between tricks at my table. I found that it was quite the usual large-sized submarine, of which the navy had an even hundred not counting ours. It was driven by electric motors supplied by turbine driven generators forward. It was provided with the usual gas absorption system which made it possible to run under water with our steam power, without discharging any exhaust gases; this, the first important invention of the Naval Consulting Board. But I found the forward torpedo room locked and none on board had gone into it since they had been on board, none save the chief engineer, Dickenson, a man from Parker's own electrical company, which had built this curious boat and sent it out

(Continued on page 66)

WE have published a great many stories in the past, but we do not hesitate to state that "*Eddy Currents*" is one of the very cleverest we have ever printed. Not only is it a rattling good story, but the scheme is so plausible that we venture to prophesy that it will be actually tried in the not too distant future. And then, the submarine will earn its adjective "*deadly*" in the fullest sense of the term.

to make a difference in the load on the coil. You see that don't you?"

I did. That was perfectly plain sailing, electrically.

"Well then, when this load comes on, the lamp lights up as a signal, and this dial here which is really a calibrated galvanometer, shows how far away the object is."

He pointed to one of the three dials which I had noticed was calibrated in yards.

IN THE JUNE "E. E."

An interview with Thomas Alva Edison, including some new photographs of the famous inventor.

Electricity and Life by Dr. Frederick Finch Strong. Part III of this interesting and valuable series.

Woman's place in the Wireless game—A page of female radio operators who have made good.

The How and Why of Radio Apparatus. Part IV. Spark Gaps.

The Calculation and Measurement of Inductance. Part III of this valuable series by H. Winfield Secor and Samuel Cohen.

Another gripping electrical tale—"In the Way" by C. M. Adams. Don't miss it!

Feature Article—"Electricity's Aid to the Fair Sex"—of interest to everyone.

Building a High Frequency Alternator for use in Radio by S. Cohen.

Experimental Physics. Fifth Paper by John J. Furia, A.B., M.A.

An Electric Player for Tubaphones.

A home-made electric searchlight for the amateur by Frank M. Jackson.

"What are the other dials for?" I asked.

"They are to give the angle of the coil, both in the horizontal and vertical planes. You see both are calibrated that way. These wheels here turn the coils about and raise and lower them, and this third wheel operates the mechanism which raises

118 VOLTS CAN KILL.

The Ontario Electrical Inspection Department of the Hydro Commission are out hot foot after delinquents who try to work in jobs without permits and convictions are being rendered every week, says a writer in the *Electrical Safety Magazine*.



Never Touch Electric Light Fittings or Wiring While Standing In a Bath-Tub or On Damp Floor, as the Consequences May Prove Fatal.

One person is to come up before the board for refusing inspector admission to premises and others for not returning to remedy defects on jobs before expiration of inspectors' notices.

In the City of Toronto, in the month of October, a young man, nineteen years of age, was in the bath-tub and, so far as his parents knew, he was enjoying the harmless and healthful pastime immensely, judging by the sounds of splashing and rubbing emanating from the keyhole.

The happy sounds were suddenly interrupted by a deathly shriek, and his parents upon breaking into the room, found him doubled up with the coils of a long portable lamp cord wound round him and the portable lamp in the bath. The lamp was an ordinary brass desk lamp provided with the silk cord.

The cord was worn, showing bare copper spots. What he was doing with a lamp in the bath no one knows.

The bathroom was provided with a brass bracket well up above the bath with a portable socket.

Test revealed that 118 volts, 25 cycle current was used, one side grounded, the fixture itself clear of ground and well insulated from both the grounded and ungrounded sides of the circuits.

The investigations show that he was killed by coming in contact with brazed cord carrying 118 volts, 25 cycle current.

This proves two things: First, that 118 volts can kill, and secondly, that indifference to bare spots on cord is dangerous.

One quarter of a dollar spent on renewing this cord would have saved a young life, a doctor's bill, an undertaker's bill, and the parents' grief. Is it not worth while? Safety First! should be the slogan of every user of electric service, whether for half a dozen lamps or for a large factory. Again—when you stand on a damp or wet floor or in a bath-tub, don't touch an electric switch or fixture!

A LINEMAN'S SHOE THAT WITHSTANDS 20,000 VOLTS.

A leading American maker of lineman's protective devices, which for several years has been marketing protective shields to cover wires and cross-arms where men are working, has now developed an insulating shoe for electrical workers. Thruout

their entire life a pair of these shoes, the manufacturer states, will provide the wearer protection against circuits at pressures up to 20,000 volts and will not cause the discomforts of many of the rubber soles.

The shoes are molded by a process similar to that used in making automobile tires. The shoes contain no cement and have no seams, but are vulcanized into a solid piece under high pressure on aluminum molds. No hand work is employed in the process. This method of manufacture makes it impossible for the completed shoe to peel or come apart and prevents injury from oil, gasoline or grease.

In order that the shoes may, in the interest of safety, be distinctive, they are all made exactly alike with brown heels, white soles, brown vamps and black tops. The white soles are made of a rubber composition like that employed in certain types of coal miners' shoes, which have been found to give eighteen months of constant wear. When this white sole wears thru, a layer of red rubber, which will itself withstand a pressure of 20,000 volts, is exposed. The appearance of the red rubber is a signal or reminder to the wearer that, altho his shoes still will withstand 20,000 volts, a new half sole should be immediately cemented or vulcanized in place.

The brown rubber also extends under the white sole. It is this piece of material which is capable of withstanding high potentials. One of these shoes, when tested

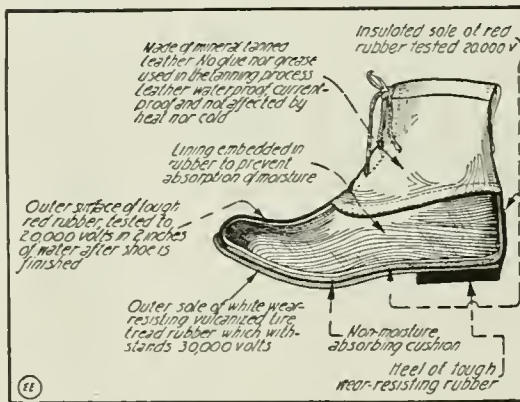

Remarkable New Shoe for Lineman Which Is Capable of Withstanding 20,000 Volts. Note That No Nails Are Used.

in the laboratories of the Edison Electric Illuminating Company of Boston, under the direction of the accident prevention committee of the National Electric Light Association, showed the following characteristics:

"Side of shoe, dry, punctured at 31,500 volts, and again at 34,000 volts; sole of shoe between electrodes in oil punctured at 55,000 volts; 20,000 volts applied from salt water to salt water for one minute and 30,000 volts applied from salt water to salt water for forty-five seconds did not puncture the rubber."

ELECTRICITY LIGHTS NEW PIPE.

An electrically ignited pipe which lights the tobacco at the bottom of the bowl instead of at the top, thus avoiding the collection of moisture in the stem, is the newest in smokers' inventions.

PECULIAR ELECTRICAL PHENOMENA.

By Walter J. Howell.

While standing about one hundred feet away from the tracks of the New York, New Haven and Hartford Railway January 10, 1917, a large steam engine pulling a heavy freight train past at the rate of five to eight miles per hour. The railroad is electrified by overhead wires, which, at this

point, were about seven feet above the locomotive, and current is sent thru them at a pressure of 11,000 volts, 25 cycles.

Directly over the engine, which was giving off a medium black smoke, the air seemed to flicker at the rate an electric light would if connected to a 25 cycle circuit. This was only noticeable when the quality of the smoke's carbon element was just right. That this flickering was not due to heat waves I proved by the fact that objects when looked at thru heat waves seem to bend or wave from side to side and move upward, while objects seen thru this vibrating air did neither, and when the quantity of carbon decreased as the wind blew, the flickering effect disappeared.

The cause of this phenomena I attribute to the attraction and repulsion of the carbon particles in the smoke and as the current reversed they were drawn upward and downward for a very short distance, while being dissipated into the atmosphere. The effect was not noticed a few inches above the wire. The weather on January tenth was slightly hazy, with no sun at 3.30 p.m., when this effect was noticed. In bright sunlight it could not have been seen. If my explanation is in error I shall be pleased to hear the views of some of your technically inclined readers.

MAKE YOUR PHOTO PRINTS BY ELECTRICITY.

The electric photograph printer illustrated has been brought out for both professional and amateur use. A feature of the device is an automatic switch which is operated only when full pressure is placed on the pad. The pressure pad is placed in position by a hand lever which controls the automatic switch, the light being turned on only when full pressure is exerted on the pad. The light is turned off before pressure on the pad is released, thus avoiding any blurring in the prints and assuring absolute contact. A locking device is provided which relieves the operator of the necessity of maintaining pressure on the lever during the exposing period. With a slight grip on the release catch, the lever can be freed. A locking device is also provided, permitting the white light to be turned on and the pressure pad elevated to permit accurate adjustment of masks or vignettes. In the light box of the smaller printer are one ruby and four clear incandescent lamps, and in the larger one there are one ruby and six clear incandescent lamps. The printers are designed to take 100-watt gas-filled lamps.



Electrically Illuminated Photograph Printer Equipt with Automatic Switch Actuated By Printing Frame.

The printer is being made in two sizes—8 in., by 10 in., and 11 in., by 14 in.



The RADIO LEAGUE of AMERICA

HONORARY MEMBERS
CAPT. W.H.G. BULLARD, U.S.N. NIKOLA TESLA.
PROF. REGINALD FESSENDEN. DR. LEE DE FOREST.



H. Gernsback, Manager

W. H. Kirwan, Master of Radio Relays

The Washington's Birthday Relay Prize Winners

By W. H. KIRWAN, (9XE)

Master Radio Relays, Radio League of America

WELL, boys, you did it; the first official Trans-continental M.S.G. (message) No. 1 from the Mayor of New York to the Mayor of Los Angeles, went thru with the customary speed and

by the writer, the necessary notices of which were published in this magazine. Some of you did not hear about the Relay because you are not regular subscribers. Let this be a lesson—Get your name down so that you will receive your magazine promptly and regularly.

Now, here comes the sad part. You will see "by the papers," that on this night we had good radio weather as far as the Rockies, but the writer had studied the weather man and looked for trouble southwest and west, and we had it! A healthy young cyclone was dancing merrily over Texas, Arizona, New Mexico and California, and the tail end of a regular old-time "QRM" storm was making life miserable for the boys in the war west, but with it all, 6 EA got the message direct from 9 ZF. 6 DM, who volunteered to help 6 EA, put on full power and promptly blew the fields of his gap motor, leaving 6 EA to do the honors and, by golly, he did.

Seefred Bros., delivered this message to the Mayor of Los Angeles, and promptly received his reply, but QRM and QRN were so bad by this time that it was a physical impossibility to get it thru to 9 ZF. 6 EA stuck to his post, however, and got the message thru the next night, too late for 9 ZF to find anyone out of bed. 9 XE arranged for all eastbound amateurs to be on the job, and the message came thru fine, being delivered to the Mayor of New York by Mr. Geo. C. Cannon, 2 ZK, the next morning early.

Lots of you kept me company by staying up all night waiting for the return message and now you know why it could not get back on schedule. The return message was as follows:

To the Mayor of New York City:
On behalf of the City of Los Angeles,

sage. (Signed) Fred I. Woodman,
Mayor of Los Angeles.

By counting up the total time consumed on each message, we call the race between Specials and Amateurs a tie, with the



Mr. Edward B. Duvall, Who with Mr. A. P. Smith, Operating Station "3AK," Baltimore, Md., Won "First Prize" in the Washington's Birthday Relay.

reliability of all the Relay messages we have worked on. The special stations sent the westbound message from New York on this night from 2 ZK at New Rochelle, using 8 YI, 9 XM and 9 ZF to 6 EA, which last station is in Los Angeles, Cal. Considering the time, one and one-half hours, and the great "QRM" (interference) and the repeating of message on account of misspelt words, it was truly wonderful.

The westbound message used special stations only and was as follows:

To the Mayors of Los Angeles, Cal., and Seattle, Wash.:
On behalf of New York City, I send cordial greetings to Los Angeles and Seattle, and best wishes for the success of the Radio System.

(Signed)

John Purroy Mitchel,
Mayor of New York.

Thousands of amateurs copied this message with varying degrees of exactness thruout the country, as four heaping bushels of letters have shown. This was the first relay attempted

I return your greetings and wish you continued prosperity. Congratulations to Amateur Radio on the successful mes-



Mr. A. P. Smith, Joint Operator of Radio Station "3AK," and to Whom Full Share of the Credit for the Receipt of the Relay M.S.G. Is Due.

handicap of the low wave length of the amateurs, giving them a slight preference for a decision in their favor, but my former contention still holds—that the amateurs are not yet prepared to handle these trans-continental messages with as great a degree of certainty as the Specials, unless they can get together and have emergency stations in the long jumps.

I am not posing as an expert, but candidly believe that fifty miles, worked absolutely sure, with a great number of relay stations, is more reliable than a few with long jumps, working only when the conditions permit. This is what we propose to do now by organizing the "Q.R.M. League." In it, there will be a chance for all of you to help and not just a few thruout the country who want to work every night, and who want you to shut up. You know, boys, this good old U.S.A. is a pretty big place and these Relays are run for your benefit, but there are some few in this country who
(Continued on page 61)



Radio Station "3AK," Baltimore, Md., at Which the Washington's Birthday M.S.G. Was Successfully Received in Record Time.

Electricity and Life

The Construction of High-Frequency Apparatus for Medical and Lecture Use.

By FREDERICK FINCH STRONG, M. D.

Lecturer on Electro-therapeutics, Tufts Medical School, Boston

(Second Article)

IN the March number of THE ELECTRICAL EXPERIMENTER the author pointed out that high-frequency currents, when properly tuned, acted as "Vital Boosters," increasing all the functions of the body and helping it to resist and

The author has interviewed a number of the more prominent authorities on medical electricity and they agree as to the vitalizing effects resulting from daily high frequency treatment.

Anyone who possesses a $\frac{1}{4}$ or $\frac{1}{2}$ K.W. wireless transformer, operating on 110 volt, 60 cycle A.C., can easily construct an efficient high-frequency outfit for medical or lecture use. The complete equipment includes a .01 microfarad glass plate condenser, Tesla coil, inductance, spark gap and electrodes.

The Tesla coil is made as follows: (Fig. 3) On a paper mailing tube $2\frac{1}{2}$ " diam. and 14" long wind 480 turns of No. 34 D.C.C. copper magnet wire. Set up the tube in the lathe, apply a coat of orange shellac, spin on the wire, apply a second coat of shellac and allow to dry thoroly. The winding occupies twelve inches, leaving a margin of one inch on each end of the tube. Leads of light auto (ignition) cable are soldered to the ends of the winding. A strip of waxed, corrugated paper M, 5" wide is wrapt around the center of the secondary tube and on this is wound the primary, consisting of four turns of heavy high tension auto cable, and thoroly secured by tape; at least a foot of cable should project from each end of the winding to form the primary leads. Place the coil in a wax tight box made without nails and embed it in a mixture of four parts rosin and one part beeswax. It is safer to boil the coil for an hour in the insulating mixture before placing it in the box. Coils made in this way by the writer are still giving good service after fifteen years of use.

The greatest source of trouble in a medical high-frequency outfit is the spark gap; the one described below is the outcome of many years experiment. If properly

made it will run daily for months without deterioration. The spark takes place between two pieces of brass rod $1\frac{1}{4}$ " diam. and $3\frac{3}{4}$ " long, turned and tapt as shown. The sparking surfaces are turned in annular grooves with a 60 degree angle. If

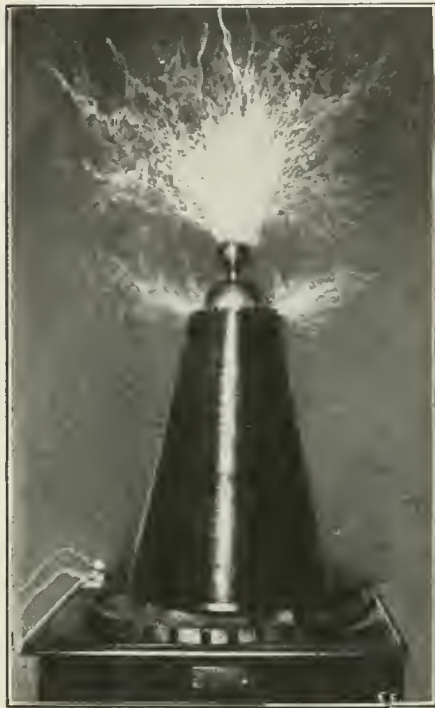

Fig. 1. View of the Strong Conical Oudin High Frequency Coil Delivering a Veritable Tree of Sparks Several Feet in Length.

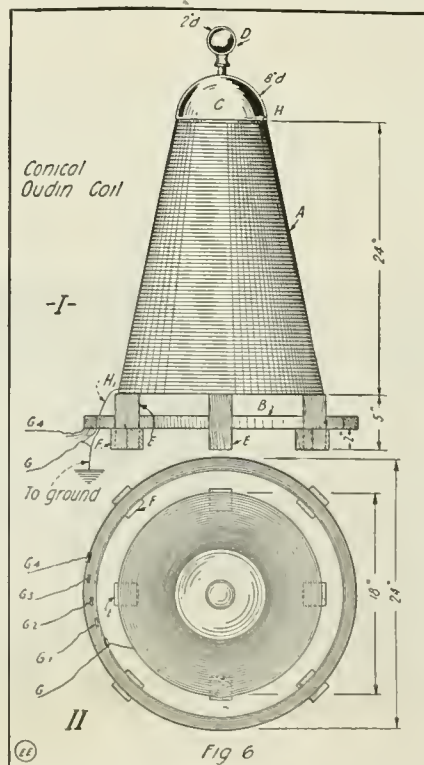

Fig. 2. Another View of the Strong High Frequency Coil Producing a Perfect Sheet of Flaming Sparks to a Grounded Conductor. The Exciting Energy is but 1 Kilowatt.

throw off disease. This vitalizing effect is not due to the mere liberation of heat in the tissues, for it is produced by the very high-voltage ("Tesla") currents as well as by the heavy amperage ("D'Arsonval") currents from which the thermic effects are usually obtained.

When the writer demonstrated the first therapeutic Tesla Coil and the first Vacuum Electrode—in 1896 before a Boston Medical Society—and suggested that this method was destined to come into general use as a vitalizing agent, he was laughed at by his colleagues; yet to-day there is scarcely a well equippt physician's office in this country or in Europe that does not contain some form of therapeutic high-frequency apparatus. Even the barber-shops of the present time have their small "Violet Ray" outfits; and these are not by any means "fakes" for they produce real results, such as the relief of headache, neuralgia, skin diseases, et cetera.

Unlike other forms of electricity, these currents may be administered to patients with perfect safety. In twenty years' experience in electro-therapeutics the author has never known of harmful results from the use of Tesla Currents applied thru a vacuum electrode. The heavy amperage ("D'Arsonval") currents, owing to their deep thermic effects, should be used only under the direction of a physician. The writer is a firm believer in the use of Tesla currents in the home—if each member of the family could receive ten-minute daily treatments from a small high-frequency apparatus, the general standard of health would be greatly increased. This has been demonstrated in hundreds of cases.



Details Are Given In This Article for Constructing a Reliable and Powerful Oudin or Tesla High Frequency Coil, Suitable for Physicians' Use. This Type of Coil is the Most Efficient Ever Designed.

your lathe has an automatic cross-feed you may set it to twenty turns to the inch, and turn a spiral groove instead of the annular rings. After finishing, the brass pieces are heavily silver plated and mounted in the usual manner as shown. (Fig. 4.) For currents over $\frac{1}{4}$ K.W., a plate of silver should be soldered to the brass before turning the grooves. This gap will also give greater efficiency in wireless work as compared with the usual stationary gap.

The connections for the various parts of the apparatus are shown in Fig. 5. An important feature is the use of an external inductance or tuning coil "d" in series with the Tesla coil. It consists of 32 turns of No. 8 bare copper wire, wound on a frame 8" diam., with $\frac{1}{4}$ " between turns. Edgewise wound flat copper strip is better but more expensive. (d Fig. 8.) This coil when used in series with the Tesla primary enables us to tune the oscillating system in perfect resonance when the capacity of the patient's body is added to the Tesla terminal. Effects are produced which are impossible with any other method. The beautiful High-frequency Effluve or brush-discharge, so valuable in treating pulmonary diseases, and which so few modern high-frequency machines can produce, is obtainable by the use of this series inductance. It may also be used, by short-circuiting the Tesla primary, as an auto-transformer from which may be derived heavy "D'Arsonval" and "Diathermic" currents as described in the next article of this series.

For stage demonstration and public lecture work the writer employs a large high-frequency resonator which produces a tree-

(Continued on page 59)

Experimental Physics

By JOHN J. FURIA, A. B., M. A.
Instructor in Physics and Science Master, Riverdale Country School

LESSON FOUR GASES AND THE ATMOSPHERE (Concluded)

AIR expands when heated and becomes lighter in weight. If we have a confined body of air such as in a room, for example, and there is a source of heat in the room, the air near the source will expand

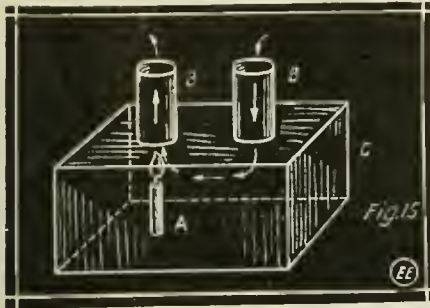

Simple Apparatus Comprising Box, Candle and Two Lamp Chimneys for Demonstrating the Principle of Ventilation.

and become lighter and the heavier air at the top of the room will fall, forcing the lighter air upward. Thus it is that the air near the ceiling is always warmer than that near the floor. This shows the necessity of opening a window at both the top and the bottom, for best ventilation.

EXPERIMENT 19—

Fig. 15 shows very simple apparatus which can be made with practically any material available, for demonstrating the behavior of air near a source of heat. C, is a box thru which holes have been cut to admit tubes (or glass lamp chimneys) B. A is a lighted candle. The arrows show the direction of the current of air.

EXPERIMENT 20—

An interesting experiment giving surprising results and having a simple explanation can be performed by the use of a spool and a visiting card. (If no visiting card is available, the ace from a poker deck which you may have "up your sleeve," will do very well.) Place the card up against the bottom of the spool as in Fig. 16-A and the mouth against the top of the spool. Blow vigorously and then let go of the card. One would naturally expect that blowing against the card would blow

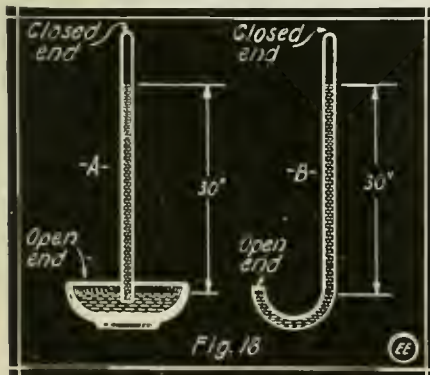

A Glass Tube, Sealed at One End and Filled with Mercury, Will Support a 30-inch Column of Mercury, Owing to Atmospheric Pressure Acting Against a Vacuum. The Principle of the Barometer.

it away whereas actually the card stays fast, close to the bottom of the spool. Sometimes, when the conditions are not

just right, the card slides off perpendicular to the direction in which one blows, but to avoid this a pin should be stuck thru the card's center and then into the hole in the spool (care being taken not to stick it into the wood of the spool). Fig. 16-B shows diagrammatically what happens. The air from the mouth passes down the hole in the spool and out along the upper surface of the card. It is a well-known fact that the pressure is greatest where the speed is least and *vice versa*. The air underneath the card is practically still, while that just above the card is in rapid motion, and hence the pressure against the card from beneath is greater than that from above. Hence the card tends to get as close to the spool as possible and does not fall.

EXPERIMENT 21—

In the First Lesson we learned that at any depth in a liquid there is a pressure due to the weight of the liquid above that depth. We also learned that air has weight and consequently we conclude that the air (at the surface of the earth) has pressure due to the weight of the air above it. The higher up we go, the less air there is above us and hence the pressure is less. If one sucks in at the stem of a pipe (see Fig. 17) at the bowl of which is stretched a piece of sheet elastic, the pressure of the air above it pushes the elastic down. Suction is not a mysterious force; it is simply a removal of the air from one side so that the pressure from

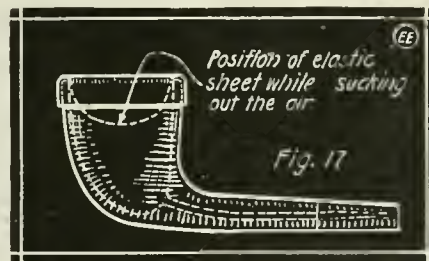

Removing the Air Within a Pipe Bowl by Sucking In Thru Stem Allows the Pressure of the Air to Push Elastic Diaphragm Inward.

the other side can act without being opposed. Actually, when the air is entirely removed from the pipe, the pressure above the elastic sheet is fifteen pounds on each square inch; i.e., the weight of the column of air from the earth's surface to the end of the atmosphere on each square inch of the earth's surface is fifteen pounds. A column of water thirty-three feet high and one inch square weighs fifteen pounds and a column of mercury thirty inches high and the same area, weighs the same (mercury weighs 13.6 times as much as water).

EXPERIMENT 22—

Seal one end of a narrow tube having a diameter of about one-quarter inch and about fifty inches long. Fill the tube with mercury and invert it carefully and place the open end in a cup containing some mercury. The mercury in the tube will fall until the height of the mercury in the tube is about thirty inches above the level of the mercury in the cup. The same level is kept no matter how long and how wide the tube is. The air pressure on the cup's surface acts against the mercury in the cup and it is transmitted thru the mercury to the open end of the tube. Since the tube was filled with mercury and there was no air at the sealed end, we get the same effect as if air was there originally

and was sucked out; i.e., there is no air pressure in the tube and the air pressure outside can hold up the mercury to a level of about thirty inches. If now the seal is broken the air rushes in and the mercury in the tube falls into the cup. (See Fig. 18-A.) The pressure of the atmosphere changes from place to place and from time to time. It is, therefore, im-

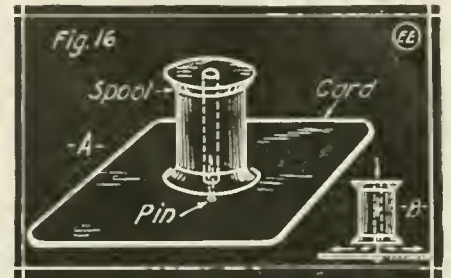

If You Blow Down Thru the Spool the Card Sticks to the Spool, Contrary to General Opinion.

portant to measure the exact pressure at each locality. It is possible to determine one's height above sea level by the reading of the barometer. Also the readings of the barometer show how the weather conditions are. The barometer is nothing but an instrument to measure the pressure of the atmosphere. Obviously our Fig. 18-A represents a crude barometer. Its great disadvantage is that when carried about from place to place one is likely to spill the mercury. An improved form is shown in Fig. 18-B. The same tube used in A is sealed again, bent at the open end and filled with mercury. The air pressure acting at the open end supports a column in the closed section, so that the height in the closed section is thirty inches above the level in the open end. In the commercial form a scale (yard stick) attached so that one can read the levels directly. This form can be carried about more freely without danger of spilling the mercury but is nevertheless cumbersome and inconvenient. The aneroid barometer is much more compact (it can be had even as small as an ordinary alarm clock). Instead of mercury to be acted upon, this instrument employs a diaphragm which is moved in and out by the atmospheric pressure just as the



A Simple Air Thermometer—Utilizes the Expansion of Air on Heating to Vary the Height of a Water Column.

sheet elastic was in experiment 21. The motion of the diaphragm is magnified by a system of levers and is communicated to

(Continued on page 47)

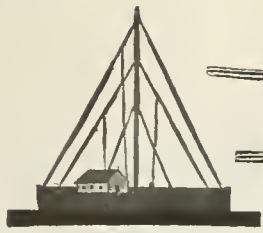

RADIO DEPARTMENT



Wireless Telegraphy*

By E. B. PILLSBURY

General Superintendent, Marconi Wireless Telegraph Company of America, New York

THE history of wireless telegraphy repeats once more the old story that is so often connected with great inventions. The world being possessed of a new scientific principle, many minds in many parts of the world are simultaneously bent upon its practical application, with the result that the fundamental principle finds embodiment in various methods of accomplishing a similar purpose. The startling nature of the discovery of electric waves was bound to give rise to unprecedented activity in the field of experimental investigation, and such experiments as were particularly successful were bound to prompt investigators to seek patent protection on their modifications, and this in turn gave rise to several systems of radio-telegraphy.

A voluminous list of names could be given of those who have contributed to the advancement of radio-telegraphy in regard to both theory and practise. Among the best-known American investigators are Fessenden, Shoemaker, de Forest, Clark, Stone and Massie. Each of these men has devised a system which bears his name. In England the work has been carried on by men

of such unqualified distinction as Lodge, Alexander, Muirhead, Fleming, Thomson and Rutherford. Slaby, Arco and Braun are the names best known in Germany. The French are represented by Ducretet, Branly, Rochefort and Tissot, besides other men of lesser fame. Italy has contributed largely to the subject, principally thru Marconi, Bellini, Tossi and Righi. Denmark is represented by Poulsen. Spain, Austria, Belgium and Argentina have all produced systems which have been more or less used in their respective countries. The Japanese have also devised a system that successfully stood the test of service in the Russo-Japanese War.

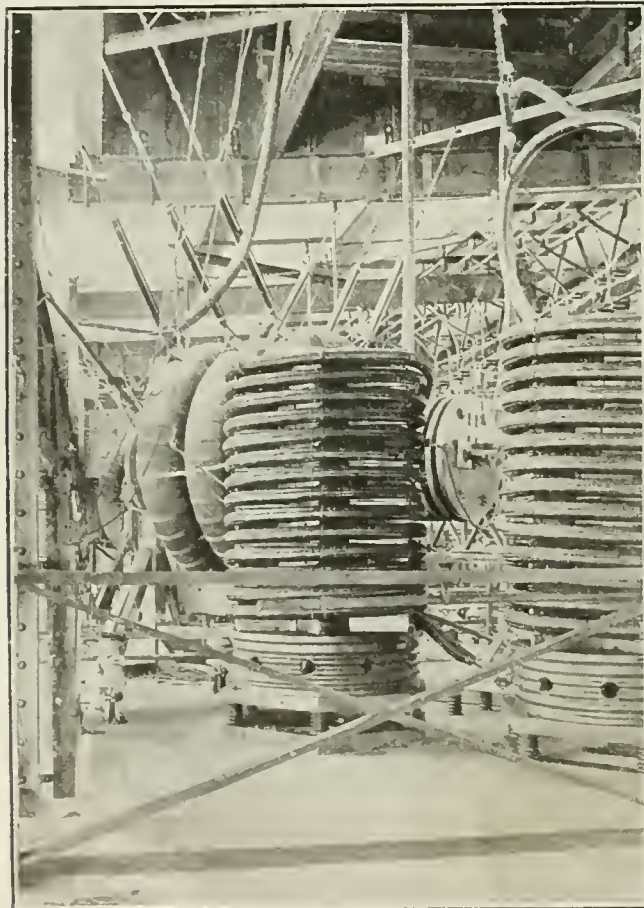

Gigantic Oscillation Transformers and Tuning Inductances in Marconi Trans-oceanic Wireless Transmitting Station.

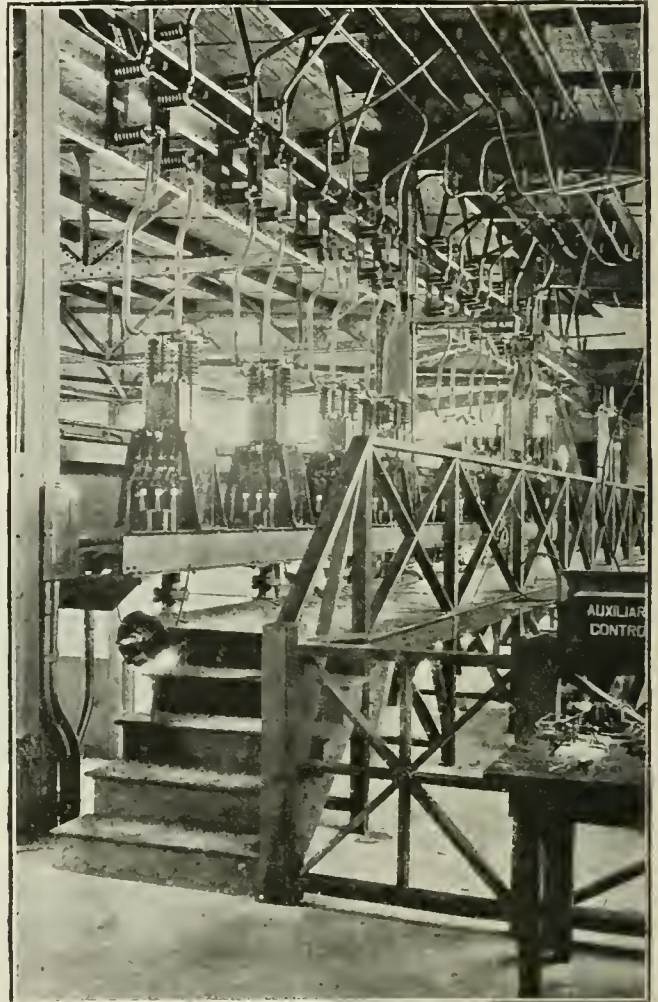

Interesting View of a Bank of High-speed, Automatic Sending Keys and Bus-bar Connections in a Typical High-power Marconi Radio Station.

The development of the art in the various countries has been carried on largely by representative investigators, and in many instances the governments have adopted a system exploited by their subjects. The United States government, however, has experimented with most of the prominent systems offered, and, as a result, the army and navy equipments are comprised of quite a variety of apparatus of different inventors.

Wireless telegraphy was the subject of earliest experimentation as

early as 1838, but, as far as the public mind is concerned, the science began when Marconi sent his first message across the Atlantic from Cornwall to Newfoundland in 1902. This wonderful accomplishment had so much of the spectacular element in it that wireless telegraphy and Marconi became famous at once and, measured by results, he has eclipsed all other inventors.

Marconi first interested himself in the problem of wireless telegraphy in 1895. In the following year he took out the first patent ever granted in England for a practical system of wireless telegraphy by the use of electric waves. In 1897 he successfully communicated across Bristol Channel, a distance of nine miles. At the invitation of the Italian government, Mr. Marconi subsequently went to Spezia, where his system was put to practical test on board two Italian battleships. A station was erected on

*International Cable Register Supplement.

land, and the ships were kept in constant telegraphic communication with the shore up to a distance of twelve miles. Returning to England he made further experiments and succeeded in communicating be-

sea-going vessels has been recognized by all nations, the United States law requiring two licensed operators on any ship carrying fifty or more persons and sailing between ports 200 or more miles apart. It is estimated that upward of 5,000 ships are now equipped, and a large number of freighters carry wireless for their own protection, altho not required to do so by law. In fifteen years wireless has placed to its credit the saving of thousands of lives and property valued at several millions of dollars. It is an inestimable boon to mankind that we can go to sea with the knowledge that we are kept in touch with home and can summon aid in case of disaster by means of the S. O. S. signal.

Radio-telegraphy is a most potent factor for naval, military and airship use in the present war. On July 30, 1914, five days before the actual declaration of war, the English fleet, which had just left Portland, was recalled by wireless; and on August 4, 1914, Germany flung around the world on its chain of wireless stations this vital message to its mercantile marine: "War declared on England; make as quickly as you can for neutral port." This first dispatch unquestionably saved Germany many millions of dollars of property and secured for possible future use a fleet of passenger and cargo boats which may yet play a great part in her recovery from war's ravages.

As long distance wireless rang up the curtain on the greatest war the world has yet witnessed, so it has continued to play a great part therein. One of the most striking points in connection with wireless, which has been developed by the war, is that public attention has been directed upon it as never before, owing to the fact that so much of the official communications, particularly German information, has been brought to the notice of newspaper readers thru this medium, owing to obstruction of the German cables.

One of the objections made against wireless telegraphy is in regard to the possibility of interference between various stations and the confusion likely to arise when a number of stations are simultaneously operated in the vicinity of one another. Altho this confusion does rarely arise in practise with proper up-to-date stations and apparatus, yet even with the old instruments when it did occur it was not by any means such a serious matter as generally appeared to the imagination of the public. In most countries the operation of wireless telegraph stations in regard to ship and shore communication is subject to judicious rules tending to prevent mutual interference. It is well known that without proper organization and discipline, serious difficulties due to interference would occur with the great majority of ordinary land wire telegraphs which work several offices by means of a single wire. In the case of wireless telegraphy it is often an advantage that any station should be able to pick up a message which may not be actually addressed to it, as, for instance, in the case of a ship in distress calling for assistance. The most practical method of isolating any particular receiver so as to make it sensitive only to signals coming from a certain station lies in the principles of resonance; that is, to tune the sending and receiving circuits in exact correspondence.

When the war broke out a German company had high-power stations in communication between Sayville, L.I., and Nauen, Prussia (3,262 miles), and between Tuckerton, N.J., and Eilvese, Prussia (3,383 miles). In order to protect our neutrality the American government took over these stations and is now operating them in the interests of the owners.

The government has erected a high-power station at Arlington, within sight of the Capitol at Washington, with a radius of 3,000 miles under ordinary conditions. It represents the first step of the Navy toward the establishment of a great chain of high-power wireless stations to girdle the earth and bring the Navy Department into direct communication with the fleet thruout the length and breadth of the seas. Unless a war vessel be in the Arctic, Antarctic or Indian Oceans, it will be at all times within the range of one of the seven contemplated stations, the other six of which are to be located at San Francisco, Honolulu, Manila, Guam, Panama and Samoa.

From the Arlington station messages can be sent to vessels stationed beyond the
(Continued on page 77)

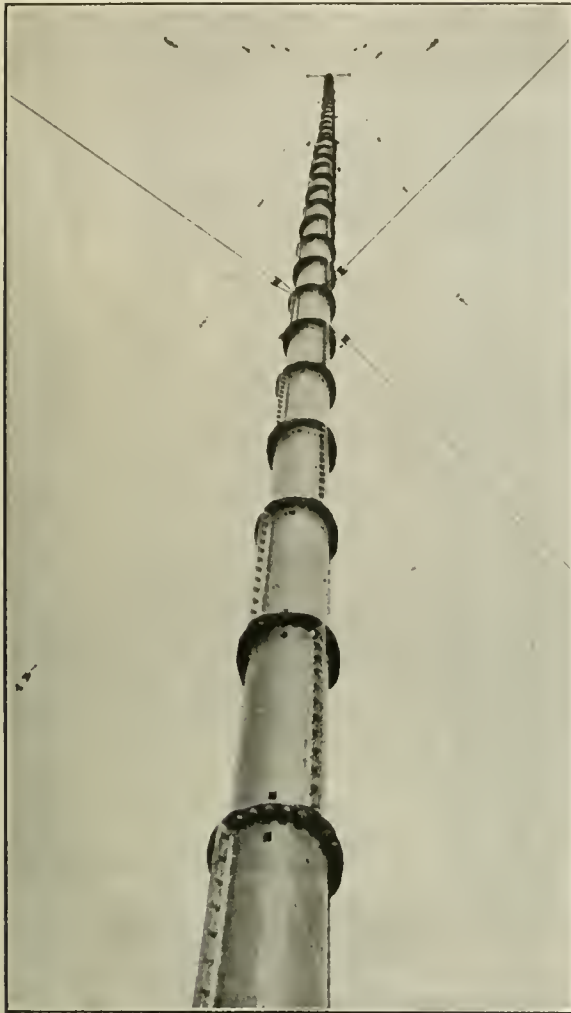

Looking Up One of the Towering 450-Foot Tubular Steel Masts, Which Support the Immense Aerials Used to Bridge the Ocean-wide Signaling Spans.

tween Salisbury and Bath, a distance of thirty-four miles.

Mr. Marconi came to the United States in 1899, in connection with the America yacht cup race between *Columbia* and *Shamrock I*. In the same year a number of ships of the British navy were equipped with his apparatus. Early in 1901 telegraphic communication was established between two points more than 250 miles distant. In February, 1902, he received, on board the steamship *Philadelphia*, in the presence of the ship's officers, good messages on a recording tape when at a distance of over 1,500 miles from the transmitting station. In December, 1902, he established a station at Cape Breton for transatlantic service, and maintained communication with the Cornwall station at Poldhu, transmitting inaugural messages to the King of England and the King of Italy, the *London Times* and others. A year later, during the voyage of the steamer *Lucania*, Mr. Marconi maintained communication between the ship and the Marconi station at Glace Bay, in Cape Breton, and Poldhu, in England, and a newspaper was published and issued daily to each passenger. A powerful station at Clifden, on the west coast of Ireland, was opened early in 1907, by means of which public communication across the Atlantic was established, which has been maintained ever since.

The importance of wireless equipment of

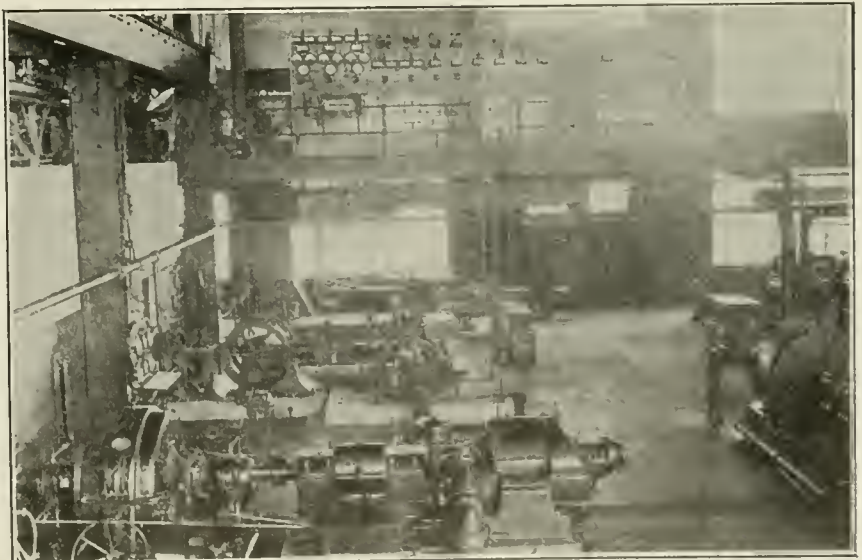

500-horsepower Steam Turbines and Generators in Marconi Trans-oceanic Radio Station.

San Diego—Largest Radio Station in U. S.

By J. BASSETT

THE new \$300,000 wireless telegraph station at San Diego, Calif., has just been completed and officially put in commission January 26, 1917. It is the largest and most powerful radio station in the western hemisphere. It is capable of flashing messages 12,000 miles. Messages

three 100 kilowatt transformers 2,800 pounds each.

Establishment of a distant control system will enable operators at any naval radio station on the Pacific Coast from Point Loma to Alaska to operate its sending instruments. This is accomplished by a system of land telegraph lines. The radio apparatus is what is known as the Federal Poulsen arc transmitter and was manufactured by the Federal Telegraph Co., of San Francisco. The Poulsen arc employs a direct current arc of 600 to 1,000 volts, burning in a closed chamber of hydrogen, the terminals being placed at right angles in a powerful magnetic

places Washington in closer touch with the Pacific Coast and particularly with the navy's larger development at San Diego. It must be gratifying to California to know that the apparatus installed is the product of a California company."

This was followed by a message from Congressman Kettner. It was as follows: "Washington salutes San Diego, first port of call by wireless. Felicitations extended thru you to people on completion of the greatest radio station in the United States made possible by your esteemed friends, Secretary Daniels and Admiral Griffin."

It was answered by Howard Veeder, vice-president of the Federal Telegraph Co., as follows:

"Please accept the felicitation of the Federal Telegraph Co. and myself personally upon the successful opening of this great radio station. It is a great pleasure to our company that the first example of this most remarkable advance in the radio art, which has been developed by us in San Francisco should be installed in San Diego, a sister city."

The radio plant is located in a section called Chollas Heights, ten miles from the business center of San Diego, on an elevation of land, reached by auto.

U. S. RADIO INSPECTORS USE CODE MACHINE IN TESTING APPLICANTS.

All applicants for U. S. Government Radio Operator's License must pass a test in receiving messages in the telegraphic code, i. e., in the form of dots and dashes. The accompanying illustration shows a new complete automatic telegraphic code transmitter, known as the Omnigraph, complete with high-note buzzer and exciting batteries, which latter are contained in the base of the cabinet. The various discs, which are properly notched on their peripheries to correspond with the dots and dashes of the different letters of the alphabet, are placed one above the other on a rotatable drum or plate, which is driven by a strong spring motor provided with a suitable governor, in order that the discs may be caused to rotate at any desired speed.

The toothed disc makes contact with a special light spring brush connected with the high-note buzzer circuit. Thus, as the discs slowly rotate, the buzzer circuit is made and broken in accordance with the long and short notches on the edges of the discs.

This instrument has been used for a number of years by the government officials in examining applicants for Radio Operator's License and has been found very satisfactory. The messages may be signaled with this apparatus at any speed from 12



Automatic Code Apparatus Used by U. S. Radio Inspectors in Examining Applicants for Operator's License.

words up to 30 words, or more, per minute, thus giving it a wide range of usefulness.

A large variety of code disc are available and the machine may be set up to give different code combinations as often as desired.



View Above Shows Mission Style Operating Building and Fan-Tail Lead-in at Powerful New U. S. Radio Station, San Diego, Cal.

At Right:—Looking Up One of the Gigantic 600-Foot Latticed Steel San Diego Wireless Towers. Below:—Concrete and Porcelain Base Support for Insulating the Steel Tower Legs.

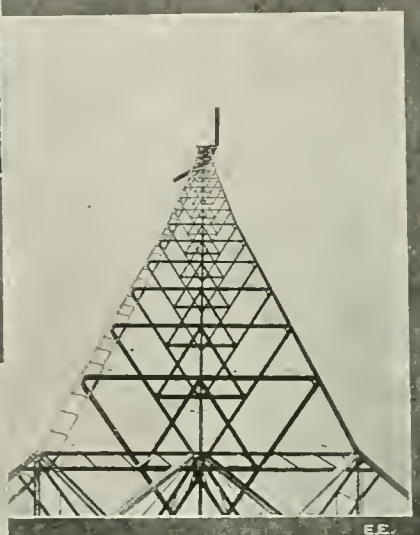
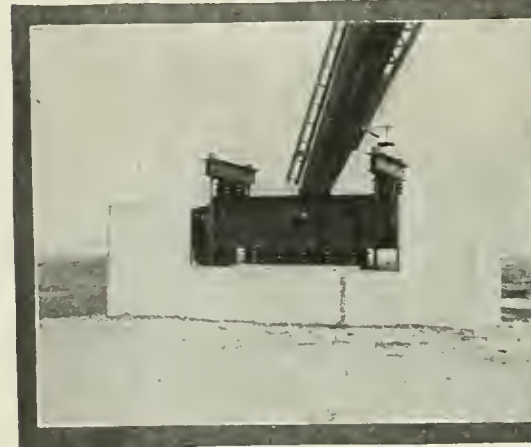

field. Electric current for the radio set is furnished by a 200 kilowatt—1,000 volt direct current generator, driven by a 300 horsepower 2,200 volt 60 cycle induction motor.

Six buildings costing \$39,590, in mission style architecture, form the quarters for those on duty. Here we find a large, airy dormitory, gymnasium and well-furnished library.

A silver plated telegraph key was presented to Commander Hooper after he had dispatched the first message. The following inscription was on the key: "High Power Radio Service, First Message, Com'd'r S. C. Hooper, Jan. 1917, San Diego." At exactly 11.02 January 26, 1917, Commander Hooper called the station at Arlington and sent this message from the Mayor of San Diego to Secretary J. Daniels:

"In behalf of the citizens of San Diego I have the honor of extending to you the season's greetings and their good wishes and congratulate you upon the completion at San Diego of the world's most powerful radio station. Space has been completely annihilated and the Atlantic and Pacific seaboard are as one."

Arlington acknowledged the message at 11.05 o'clock. It was immediately transmitted by telephone to Secretary Daniels. His reply was returned at 11.18. It was thus:

"Your greetings and congratulations much appreciated. The navy department rejoices with San Diego that the completion of the new radio station at San Diego

from the British high seas fleet cruising in the North Sea, from the high powered German plant at Berlin and from Australia have been intercepted thus far.

The three 600 foot aerial towers form a triangle. They contain one million pounds of fabricated steel and are the largest radio towers in the world. The towers are triangular in section, 150 feet in width at the base and eight feet at the apex. They are placed 1,100 feet apart. Porcelain insulators imbedded in concrete form the base of each leg of the towers.

The receiving room is absolutely sound proof, the walls and floor being padded with asbestos. There are four distinct and complete controlling sets installed in the receiving room, enabling any one of the four operators or all four at once to send and receive messages.

The aerial or antennae weigh 16 tons and has a sag between towers of 100 feet. The aerial is twice as large as that strung from the Eiffel Tower in Paris. The helix is 14 feet in diameter and 11 feet in height or 9 feet higher than the helix used in ordinary naval and commercial stations.

The generator weighs 60 tons and the

WIRELESS OUTFIT ON MOVING VAN TRACES MESSAGE.

After a search of three months for an amateur wireless operator who sent out unsigned "SOS" messages in the neighborhood of New York and caused great annoyance to the New York Navy Yard and navy vessels the federal authorities recently arrested William F. Eckoff, sixteen years old, who had a wireless station on the roof of his home in Brooklyn.

When the messages were first heard there were reports in shipping circles of submarines operating near New York. After several of these calls stations nearby recognized them as the work of an amateur. The New York Herald's wireless station worked with the operators at the New York Navy Yard in an effort to locate the station. The log at the Herald's wireless station shows that these distress messages were sent at all hours of the night. The mysterious operator used the calls of the Navy Yard and naval vessels.

Louis R. Krumm, chief radio inspector of the Department of Commerce, engaged a moving van and installed in it a small wireless set which could detect messages within the radius of only a block. Operators had traced the messages to Brooklyn, and, with the moving van, Mr. Krumm went about Brooklyn until he arrived in front of the Court Street house.

It is alleged that Eckoff used a United States code signal on the night of January twenty-first last, sending an "SOS" call which which was picked up by the Herald station and relayed to the super-dreadnought Arizona at the New York yard.

Eckoff was arraigned before United States Commissioner Louis Bick and admitted he had been sending messages, but asserted that if he had used the United States code he had done it innocently, for he did not understand the code thoroly enough to commit a nuisance.

The efficiency of such portable radio stations has been markedly improved in recent years by the advent of spiral aerials.

An Exceptional Amateur Radio Station

The accompanying photographs show the long distance, undamped wave receiving set owned by Harvey L. Gamer, Electrical Engineer of Omaha, Neb., with which the

The amplification feature is obtained by the use of inductances and capacity in the wing circuit of an Audiotron, then a further amplification with two ordinary



Above:—General View of Extremely Efficient Experimental Radio Station Owned by Harvey L. Gamer, of Omaha, Neb. Note Phonograph at Right of Photo; the Signals are Recorded on it.

Upper Right View Shows the Well Designed Antenna Used With the Apparatus Here Illustrated.

Lower Right:—Close View of 15,000 Meter Precision Loose Coupler and Audion Tuning Inductances. An Engineer's Idea of How an Amateur Station Should be Built.

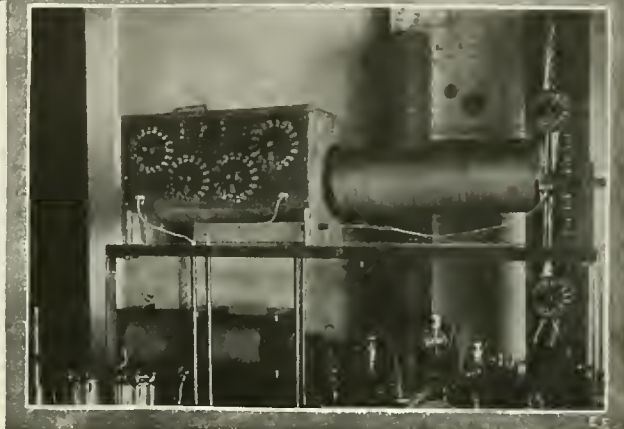

German Stations OUI, (Hanover), POZ, (Nauen) and the Honolulu Station KHL, are easily heard.

Some of the stations in the United States, WSL (Sayville), and especially WGG (Tuckerton), when the Goldschmit alternator is used, come in so loud that the signals can be transmitted over the telephone to any part of the city or vicinity. Also wax phonograph records have been made with a special recorder, as shown in the photograph.

Andions and their respective coils and circuits as well as a micro-phone arrangement leading to the recording machine.

The large loose coupler was designed to tune to wave lengths up to 15,000 meters when used with this particular aerial system.

SECRETARY OF COMMERCE SUSPENDS ISSUING OF LICENSES

Issuing of licenses for amateur wireless apparatus was suspended on March twenty-seventh by Secretary Redfield. Virtually none of the amateurs have sending equipment, so the military and naval authorities have not considered them a source of immediate danger, but Mr. Redfield decided that no more should be licensed for the present. Sending wireless plants are under the strictest possible surveillance now, and if a state of war is declared efforts will be made to locate apparatus of every description.

Many of the amateurs now licensed by the Government belong to the Navy radio reserve and will be called upon to perform certain duties in war.

TO TEACH GIRLS WIRELESS

At a meeting of the National Special Aid Society recently, a school offering a course in wireless telegraphy for young women was organized. Instruction will be given at the society's headquarters, 259 Fifth Avenue, New York City.

Miss Daisy Florence, chairman of the new branch, urges that all young women who would like to take up this class of work send in their applications. E. T. Bicak, a New York radio expert, has been retained and will have entire charge of the classes. This new department, the society says, is the first of the kind.

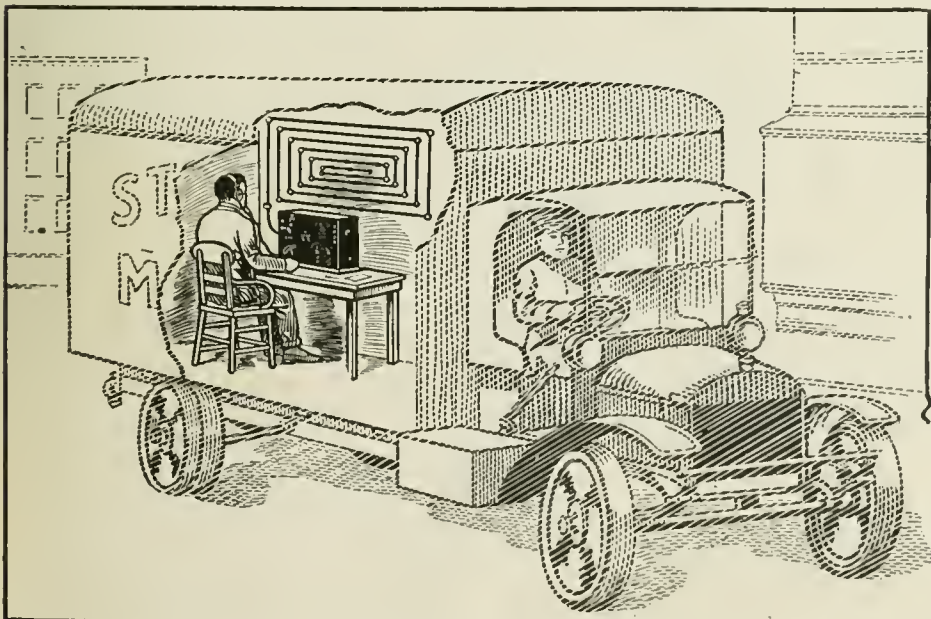

Uncle Sam's Radio Inspectors Find It Difficult at Times to Accurately Locate and Run Down Stations which Disobey the Law, but a Radio Set and Aerial Erected Inside an Auto Van Helped to Solve One Problem.

How the Audion Repeater Repeats

A Twentieth Century Fairy Tale, Wherein the Mystery of the Audion Relay Is Explained for the Benefit of Radio "Bugs" of All Ages—From 9 to 90

YOU all remember what you learned at school about matter being made up of *molecules* and molecules being made of *atoms* beyond which matter is indivisible. That is, with a meat axe, you can divide a substance into small pieces like hash; and with a microscope and hair-splitting equipment you can divide a substance into pieces smaller than the naked eye can distinguish; after that by means of chemicals you can separate molecules from each other altho you can't see them, even with a microscope; then with more chemicals you can separate the atoms from each other, but beyond this no treatment has any effect; at least that's what we learned at school and that effectually proves that there are no such things as fairies or daemons.

But now come our highbrows with another story. Mind you, you don't have to believe it. They say that atoms may be made to *throw off particles* like a small boy throwing gravel at the passing trolley car, only the kiddies do it voluntarily for the fun of the thing, whereas the atoms must have some provocation; for example, if they get good and hot they commence to throw gravel like a terrier pup at a woodchuck hole.

Now, all ordinary people know how to take such talk as this. It's just like Arabian Nights and Dr. Cook stuff about stones talking and mountains splitting open, or the beautiful stripes around the North Pole. Nevertheless one of our cloister experts will draw you a picture like Fig. 1, to represent the interior of a vacuum bulb repeater, and says that "F" is a filament, which is heated red hot by the electric current from battery "A," and "P" is a plate which is connected to the outgoing line. In the space between the filament and the plate is the piece of picket fence "G," which is connected to the incoming line, and this gridiron is what puts the *fire* in amplifier.

To make the matter perfectly clear, as a fairy tale should be, look at Fig. 2, where instead of a filament there is an iron stepladder on which you can see a lot of atoms, or daemons—it doesn't matter which you call them—and on the other side you see the plate as in Fig. 1. Between these two is an ordinary window blind with slats which are all operated together by the usual center stick. Now, suppose a strong electric current is past thru the iron stepladder so that it heats up like the filament in Fig. 1, then each little daemon gets as mad as a hen on a hot griddle and begins to throw pebbles at the window shutter. What's that! Where do they get the pebbles? Say, this is a fairy story and you must not ask foolish questions. Lord Kelvin thought the atoms were made of these pebbles or corpuscles, and that these pebbles or corpuscles were, in fact, electricity itself, hence the name *electrons*. In other words, matter is made of electricity and electricity is imponderable; therefore, there is no matter, and if there is no matter,

it doesn't matter, and we should worry.

If while the daemons are bombarding the shutter we should open the slats, enough pebbles would go thru and strike the plate to make a noise like a hailstorm on a tin roof and the number that strike the plate would be in proportion to the amount the slats are opened. Therefore, if the slats are opened and closed in time with music it would be possible to play a tune on the plate, and if each *electron* carried a little bit of electricity with it, the effect would be like a current from the stepladder to the plate, and this current would pulsate, increasing when the slats are opened and decreasing when they are closed.

This is just what happens in the vacuum repeater bulb shown in Fig. 1. The filament is heated red hot by the current from battery "A," and at this temperature mil-

You all remember that *unlike* polarities of electricity attract each other while *like* polarities repel, and so if the gridiron is made negative to the filament the electrons will be repelled by it and very few will get thru between the slats; in fact, if the slats are too close together no electrons at all will get thru to the plate. The effect would be the same as tho the slats in Fig. 2 were entirely closed.

It is generally known how the sound waves produce electrical pulsations in a telephone line; and you have only to imagine these pulsations of current coming to the induction coil "T" at the left side of Fig. 1. These pulsations are, of course, very weak because of the long line over which they have traveled and the purpose of the repeater is to amplify or strengthen these pulsations.

Now, while it takes considerable power to open and close the slats of a window blind, especially if you painted them yourself last spring, the operation of the electric shutter is frictionless and even the weak impulses of speech transmitted over 500 miles of line are sufficient to give the desired results so that as each increase or decrease of current raises or lowers the negative potential of the grating "G," more or less electrons each with its infinitesimal charge of electricity get thru from the red-hot filament to the plate and give the exact same, but much stronger, impulses of current from the plate to the induction coil at the right side of the picture, and so out on the line for another 500 miles, the amount of additional *pep* put in the impulses, depending on the strength of the battery "B."

Now you are probably wondering why this apparatus is put in a glass case. The reason is that the scheme will only work in a very good vacuum because a clear space is necessary for the electrons to travel in. You must remember that everything, even an invisible gas, is composed of atoms, so if there was air or any kind of gas in the space between the filament and the plate, the electrons would bump the atoms of the gas while the daemons might put a good many across, the number would not be constant from minute to minute, depending on how successful they were in dodging the atoms and the result of this would be a jerky current which would entirely mask the telephonic pulsations. Therefore, in order to obtain the required accuracy of control of the rate at which the electrons strike the plate, it is necessary to pull out of the space between the filament and the plate every loose atom that it is physically possible to get hold of.

This is so important that our highbrows have developed an extremely interesting method of inducing daemons themselves to call the game when the space is cleared, but that is another story to be told when you have recovered from this one.—"H.E.N."

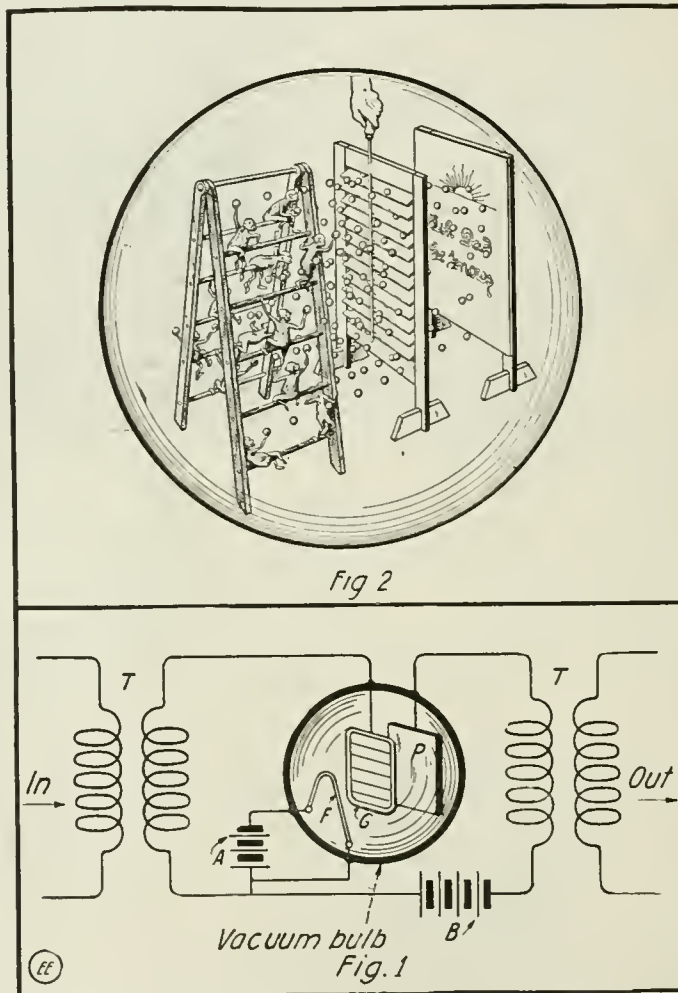

The Above Illustrations Help to Make Clear in the Most Simple Manner, the Action of the Audion—That Mysterious Radio-electrical Device. Considering the Top View, Just Imagine That the Host of Daemons on the Ladder (the Filament) Start Throwing Pebbles Thru the Movable Slats (the Grid) at the Target (the Plate). How Do They Get the Pebbles?—Oh! Well—Read This Remarkable Tale.

lions of corpuscles or *electrons* are thrown off. The electric current is not necessary to cause this; the same thing would happen if it were heated by a gas flame. These electrons are considered to carry charges of *negative* electricity itself. Here again we should worry, because the result is the same, no matter what anyone thinks; because a current actually does flow from the filament to the plate.

The Ionic Radio System and Theory of Ionic Tuning*

By Otto E. Curtis

Associate Member of the Institute of Radio Engineers

THE physico-chemical science pertaining to the elemental constitution of matter and the relation of the *ion* to the organization of matter dates back to the time of Thales of the so-called "early school of Ionic Philosophers," which came into existence about six centuries B.C. Thales, and



The Apparatus Used in Ionic Tuning of Radio Messages According to the Method of Mr. Curtis, as Described Herein.

the other scholars of this time, made little real progress toward a scientific development of the subject, altho in the light of recent discoveries many of their heretofore seemingly crude experiments and theories appear to have surprising significance.

For example, the ancient Alchemists of this period made many attempts at "transmutation," that is, at converting basic metals such as lead into precious metals such as gold, and in connection with these experiments they developed theories which, while entirely too vague to lead to useful conclusions, bear similarities to the modern theories pertaining to the transmutation or transformation of various radio-active compositions of matter into other compounds having different *ionic groupings*. However, the secrets pertaining to the part played by ions in the constitution of matter have not, at least up to the present time, been discovered and subjected to the use of man.

During the past eleven years I have been continually striving to fathom some of these secrets and it is my present purpose to disclose one of the more important discoveries which has resulted from my investigations, this particular discovery forming the basis of one of my earlier patent applications. And in order more clearly to set forth this discovery I shall first describe some of my experiments and the apparatus employed.

The first machine I built with the object of recording messages was completed in 1906. It consisted of an E. I. Co. "Auto-coherer" connected to a "Telimco-meter" galvanometer with contacts on the needle. Impulses received by the auto-coherer were intended to deflect the needle and close relay contacts, but they did not do so and this machine failed to operate. This was an attempt to find a self-restoring coherer, but, while the coherer was self-restoring, it was not sufficiently responsive to current of the magnitude which I then employed.

A later machine, completed November 25, 1916, and shown in the accompanying photograph, follows the same original idea but its special parts have been much more highly developed. It receives perfectly the time from Arlington at a distance of 200 miles, *ticking it off clearly on a buzzer and making tape records of the same*, but as yet

it is not quite fast enough to copy actual commercial messages. It was originally designed as a *chemically tuned* call-bell for a wireless telephone, for which it works excellently. (This process of *chemical tuning* or *ionic tuning* will be explained further on.)

The apparatus illustrated in the photograph is made up as follows: The device shown in the upper left-hand corner is a Multi-audi-fone pocket wireless set. The wooden base in the lower left-hand corner carries two of my *ionic* detectors constructed as shown in Fig. 5, and as hereinafter described, the one on the left comprising a zincite crystal and the one on the right a silicon crystal. The rectangular instrument in the center is a Weston relay, which comprises an extremely sensitive galvanometer having a very short needle which, when deflected, contacts with one of the platinum-iridium points disposed on opposite sides of the needle. The instrument on the right is an E. I. Co. polarized relay of 1,000 ohms resistance which may be connected to an indicating or recording or other device such as a buzzer, tape recorder, motor, lamp or explosive device.

In the accompanying figures, Fig. 1 shows the circuit connections for the apparatus shown in the photograph, the various instruments being diagrammatically illustrated in the figure in the same relative positions as in the photograph for the sake of clearness. The antenna 1 is connected to ground 2 thru the primary 3 of the Multi-audi-fone set, the secondary 4, of which is arranged to be connected to the Weston relay by means of double throw switch 5 either thru detector 10 or thru detectors 7 and 8. When the switch 9 is to the left,

7 and 8 being connected to the secondary 4 by leads which are not shown. The circuit connections as existing when the switch 5 is in upper position, are shown in simplified form in Fig. 2, reference to which may be had in following out the operation.

The alternating current of radio frequency received by the open antenna circuit 1-3-2 is induced into the secondary circuit, where it is rectified by the detector 10 and conducted to the Weston relay 6. This produces a deflection of the relay 6 which in turn closes the local circuit containing the polarized relay 11 and source of e.m.f. 12. This actuates relay 11, which closes the circuit thru a second source of e.m.f. 13 and the indicating, recording or power apparatus 14. By employing one of my improved *ionic* detectors at 10, very feeble impulses may be detected; and by employing a series of relays in the manner described, the feeble impulses may be magnified to any desired extent, each consecutive relay controlling a heavier current so that the last circuit 11-13-14 may comprise a power circuit carrying current of any strength.

When using the machine for lecture purposes, with the sender in the same room a "Hertz" lineal resonator is used instead of an aerial and ground, as shown in Fig. 3. This consists of two 1/8 inch brass rods fitted on adjacent ends with brass balls of equal size and separated a short distance, this distance bearing a direct ratio to the length of the spark gap of the sender. The free ends of the rods are fitted with the movable metallic plates 15. Moving these plates together with the similar ones on the oscillator of the spark gap tunes the system. This "resonator" serves the same pur-

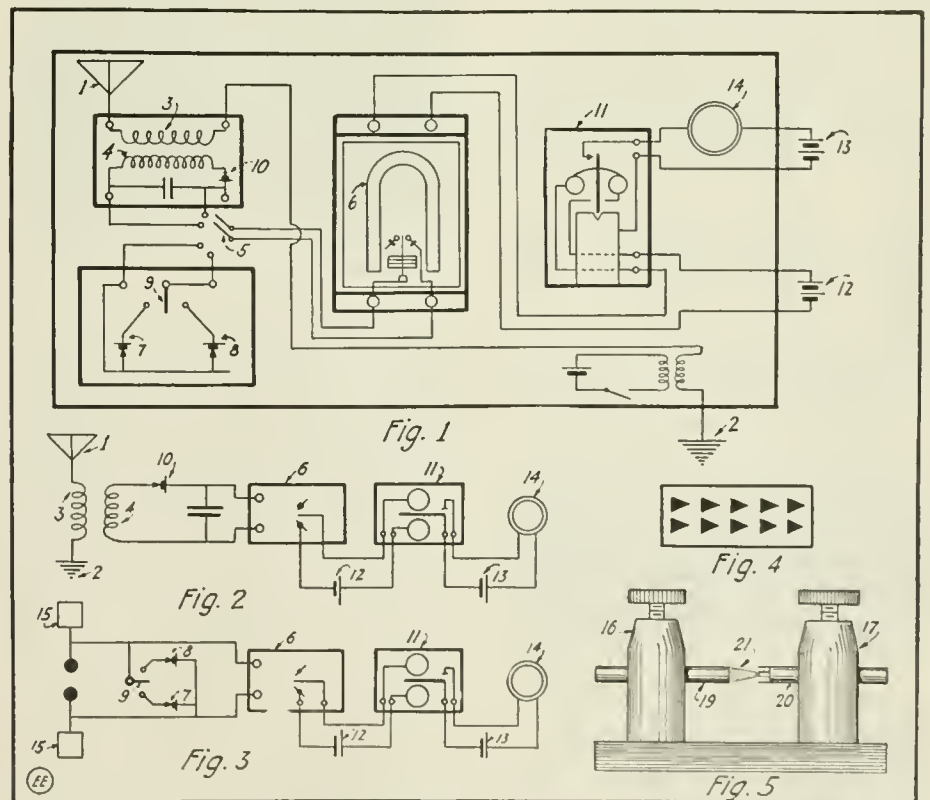

Diagram of Connections Used in the Curtis Scheme of Ionic Tuning. Whereby It Becomes Possible to Realize the Highest Efficiency in Radio Transmission and Reception, It is Claimed. Besides, It Enables the Operator to Record the Messages if Desired.

the zincite detector 7 is connected in circuit; when the switch 9 is to the right the silicon detector 8 is in circuit, the detectors

pose as the "catch wires" used on the E. I. Co. "Telimco Coherer Set." The resonator, (Continued on page 73)

* Copyright 1917 by Roberts, Roberts and Cushman. Exclusive rights to THE ELECTRICAL EXPERIMENTER.

Receiving Marconi 300 K.W. Spark Stations with Oscillating Audion

By SAMUEL CURTIS, Jr.

It is a widely known fact that the Marconi Wireless Telegraph Company has in operation a number of 300 K.W. spark stations, used for the purpose of handling their enormous traffic between different countries. The stations of this character which are actively engaged, to my knowledge, in transacting business at the present time, are: Clifden, Ireland; Glace Bay, Nova Scotia; Bolinas, California; Koko Head, Hawaii, and Funabashi, Japan.

The wave length used in transmission ranges from 4,000 to 8,000 meters, but the most common is 6,100; this is used extensively at the Koko Head and Bolinas stations.

In receiving the signals from these stations, any Audion receiver capable of attaining the wave length may be used, and it may be well to state that the undamped wave receiver described on page 575 of the December issue of THE ELECTRICAL EXPERIMENTER has been used in this respect with marked success. The writer wishes to state, however, that since the publication of his article relative to this receiving set, a fixt condenser of .005 m.f. has been added to the circuit. This is hooked up across the telephones and high potential battery of the Audion, and by its use allows the bulb filament to be burned at a much lower brilliancy, and yet get strong oscillations therefrom.

It is, of course, easily possible to receive these stations on a crystal detector, but unless an extremely large antenna is available, this cannot be accomplished over any great distance. It has been found by experiment that a heterodynic action on the incoming signals produces a remarkable increase in audibility, therefore making it feasible to incorporate the use of an oscillating Audion in this respect.

The series of graphs shown in Fig. 1 clearly illustrate the character of the momentary currents produced by a feebly damped wave train, in the circuits of a radio receiver during the process of heterodyning. In graph "A" we have the feebly

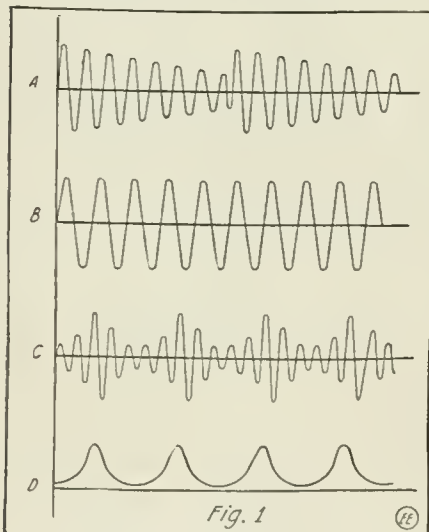

The Series of Graphs Shown Above Serve to Illustrate the Character of the Momentary Currents Produced by a Feebly Damped Wave Train, in the Circuits of a Radio Receiver During the Process of "Heterodyning."

damped wave train, such as is sent out by the above mentioned high-powered stations. In graph "B" we have the local or Audion oscillations, which are used in heterodyning the wave train of graph "A." These

Audion oscillations are tuned to a frequency either *higher* or *lower* than that of the incoming wave, so that an audible note is obtained in the telephones. In graph "C" we have an illustration of the current produced after "A" and "B" have coincided with, or heterodyned each other. In graph "D" is shown the resultant current after it has been rectified. It should be understood that the tone of this current in the telephones is proportionate to the difference in frequency of the incoming wave, and the Audion oscillations; for instance, a wave length of 6,000 meters would have a frequency of 50,000 cycles. In order to get an audible note of 500 cycle pitch, we would have to have an Audion frequency of either 49,500 or 50,500 cycles. This is assuming that we are heterodyning an undamped wave. Of course when a damped wave is heterodyned it cannot be expected that a pure note will be obtained, owing to its irregular form. In actual practise the note obtained in heterodyning the Marconi signals is very near the same as that obtained by using a crystal, only a little distorted.

The beauty of the use of the heterodyne reveals itself in an astonishing increase in the amplitude of the telephonic current, as illustrated in sketch No. 2. It can be seen by observation of this sketch that the mere rectification of a wave train does not in any way amplify it. Now, if the same wave train is heterodyned, an increase in amplitude similar to that illustrated in sketch No. 2 is obtained. The reason for this is best explained by the fact that in the mere rectification of a damped wave train, only the first few oscillations are utilized, and the rest of the energy is hopelessly wasted. In subjecting a feebly damped wave train to heterodynic action practically all of the energy is utilized, manifesting itself in an enormous increase of audibility. To those who are more or less familiar with the action of the heterodyne, this brief explanation will suffice, but to go into a detailed description thereof would be out of the scope of this article.

It might be of interest for the reader to know that at the present time, at a certain experimental station on the Atlantic Coast, signals are being received daily from the Marconi station at Koko Head, Hawaii. The receiver used is of the type described in the December issue of this journal with the single exception that an Electron Relay is used instead of the usual spheric Audion bulb for producing the oscillations. Glace Bay, Nova Scotia, comes in with remarkable audibility, while Bolinas, California, is read nearly as loud. The stations at Clifden, Ireland, and Funabashi, Japan, have not as yet been picked up, but it is expected that in the near future Clifden will be copied, as this station is not nearly as far distant as Koko Head, who is read in the daytime in good weather. The aerial used at the above mentioned station has a natural period of 276 meters, and is none too elaborate.

The results made possible by the oscillating Audion in receiving damped waves are not however confined to such long waves as are used by the Marconi stations. With careful adjustments and the use of low resistance inductances, an Audion can be made to oscillate on 200 meters or less, depending of course upon the skill and perseverance of the operator.

No one can fully appreciate the efficiency of such a method of reception until he has actually used it himself. At the present time there are a number of *Regenerative* receivers on the market. These instru-

ments are without a doubt the peer of anything in their line, but for many experimenters the price of such an outfit is prohibitively high, and the chances are they have to do without. One advantage, however, is that these receivers are not so intricately designed as to make it impossible

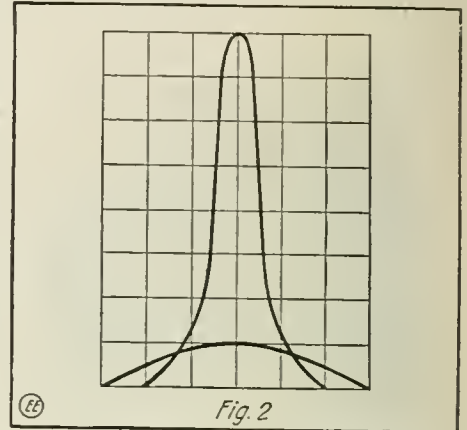

Graph Illustrating the Marked Increase in the Amplitude of Received Radio Signals Due to "Heterodyning" by Means of the Oscillating Audion.

for the experimenter to make one for himself. This is being done with great success by a large number of amateurs throughout the country. If the reader cares to take the trouble to consult page 575 of the December issue of this magazine, he will see a neat little regenerative hook-up given in set "B" of the diagram on that page. Set "A" is used for long waves, and set "B" for waves from 200 to 2,500 meters.

[We are informed by Mr. Curtis that in some tests conducted in the laboratories of the General Electric Co., in Schenectady, Dr. White has succeeded in making an Audion oscillate (heterodyne action) on a wave length as low as 1/2 meter. Of course this requires some elaborate tuning and even more elaborate apparatus.—Ed.]

RADIO EXHIBIT AT NEW YORK AERO SHOW.

At the recent Aeronautical Exposition held in New York City, serious consideration was given to radio equipments for aeroplanes and balloons. A large space was set aside for the exhibition of different types of sets, such as are used now in the European countries for directing the artillery from aeroplanes, for interfering with stations and for long distance communication to be used by observers. Models of the different types of wireless equipments using direct and alternating current generated by small dynamos which get their power from the air by means of a small propeller were shown. The Marconi Company was invited to exhibit the set which was recently purchased by the Navy Department for hydroaeroplanes. This instrument has one K.W. capacity and it is stated that up to 300 miles will be obtained. That is to say, the aeroplane can signal for a radius of 300 miles. The total installation will come within 100 pounds. Other sets made by the Sperry Gyroscope Company, De Forest Radio Telephone & Telegraph Company; William Dubilier, Wireless Specialty Apparatus Company, Cutting & Washington, Manhattan Electric Supply Company and Mr. A. B. Cole. The wireless operators were supplied by the East Side Y.M.C.A. under the direction of Mr. Boehm.

Distributed Capacity and Its Effect

By SAMUEL COHEN

DISTRIBUTED capacity may be defined as the capacity existing between turns of a helical coil. It may also exist in straight conductors where the electrostatic capacity is between the conductor and the

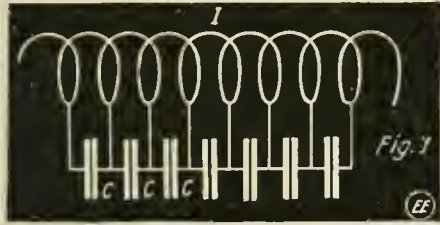

Theoretical Relation of Distributed Capacity to Inductance Coils. The Effect Is the Same As if a Number of Small Condensers Were Connected Across the Turns on the Coil.

earth, or between two adjacent conductors. It can be shown by actual experiment that a difference of potential exists between adjacent turns. This potential difference creates an electrostatic field and energy is stored between the conductors.

A condenser is a device which stores electrostatic capacity. It is evident therefore that a condenser is formed, the plates of which are the adjacent conductor turns. The capacity is stored in the space between each turn of the coil and over all of the turns, therefore the capacity is distributed over the entire conductor.

Referring to Fig. 1, it will be seen how distributed capacity is related to coils. Increasing the length of the coil, increases the distributed capacity as it is seen that the number of condensers as increased. Since increasing the number of condensers in parallel increased the capacity, therefore we may consider all the parallel condensers as one large capacity shunted across the inductance, as indicated in Fig. 2.

When capacity and inductance are linked in a circuit we have an oscillatory circuit, and the period of vibration of such a system is directly proportional to the square root of the product of the inductance and capacity multiplied by a constant. Expressing the above in an algebraic form we have:

$$n = \frac{1}{2\pi \sqrt{L \times C}} \quad (1)$$

Here n = period of vibration of the system. The wave length of the above current is,

$$\lambda = 59.6 \sqrt{L \times C} \quad (2)$$

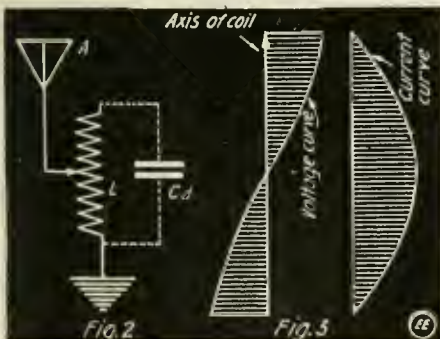

Representing the Relation of Distributed Capacity in a Coil (Fig. 2) and the Voltage and Current Distribution in Inductance Coils (Fig. 3).

where L and C are the inductance and capacity.

It is evident therefore that since the coil

has distributed capacity that the coil is an oscillatory circuit in itself, and it was found by actual experiment that when properly excited by a high frequency current, it will oscillate, the period of which depends upon the magnitude of the units of inductance and capacity.

The true wave length of a circuit containing a large inductance and shunted with a capacity is not the same when calculated with formula (2) but the exact wave lengths will be as express in the following relation:

$$\lambda = 59.6 \sqrt{L(C + C_d)} \quad (3)$$

Where C is the capacity of the shunted condenser and to it we add the distributed capacity of the coil C_d . Solving for C_d we have:

$$C_d = \frac{\lambda^2 - LC}{(59.6)^2 L} \quad (4)$$

Calling the total capacity C_t equation (4) becomes:

$$C_t = \frac{\lambda^2}{(59.6)^2 L} \quad (5)$$

It has also been found by actual experiment that whenever a large coil was excited by radio frequency current it will

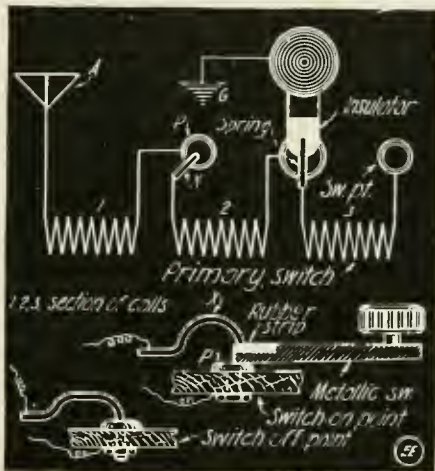

Fig. 5. Dead-end Elimination Switch for Loose Couplers Which Has Proven Very Effective in Reducing Distributed Capacity in the Windings.

oscillate in its own period just the same as a coil shunted with a condenser and excited. The current and voltage relation of this coil is exactly the same as for a Hertz oscillator, where the current value is a maximum at its center and minimum at the ends, while the voltage is maximum at the ends and minimum at the center. Fig. 3 shows grafically this relation of the coil.

The best means for determining the distributed capacity is by actual measurement. The essential instruments necessary for this kind of work are calibrated inductance and capacity which may be obtained from a wave meter, a high frequency buzzer and an additional condenser. The instruments are connected as indicated in Fig. 4. The coil, whose distributed capacity is to be determined, is placed in a single loop of wire L , Fig. 4, which is excited by the buzzer. Placing the wave meter inductance L_2 near the excited circuit the condenser C_2 is turned for indicating resonance. When the point of resonance is obtained the period of vibration of both circuits are the same

$T = T$. Substituting the observed values in the equation,

$$Cd = \frac{L_2 C_2}{L_2} \quad (5)$$

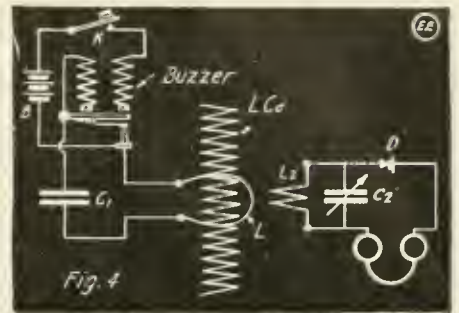

Arrangement of Apparatus for Measuring the Distributed Capacity in a Coil. A Buzzer Serves for Excitation of the Coil Under Measurement, While a Wave Meter Is Used to Ascertain the Wave Length of the Coil.

Where L_2 = the inductance of wave meter coil in centimeters.

C_2 = capacity of condenser at point of resonance in m.f.

L_1 = inductance of coil, the distributed capacity of which is to be found.

It is advisable before starting to measure the distributed capacity of a coil, to determine before-hand the magnitude of the figures so as to enable us to procure approximately the proper inductances and capacity in the wave meter circuit. It can either be found by judging it from experience or else by actually calculating its value. An approximate formula has been derived by Drude for the calculation of the distributed capacity as follows:

$$Cd = 2K \frac{2 + \frac{h^2}{r^2} + \frac{r^2}{h^2}}{10 + 4 \frac{h^2}{r^2} + 3 \frac{r^2}{h^2}} \quad (6)$$

Where " h " and " r " are the length and radius of the coil respectively. The constant K is obtained from the following table, which is for air core coils.

$h/2r$	K	$h/2r$	K
6	1.81	0.8	1.10
5	1.64	0.6	1.07
4	1.74	0.4	.94
3	1.37	0.2	.69
2	1.26	0.1	.49
1	1.12	0.05	.28

Having determined the distributed capacity of a coil, what are we going to do with this? The only thing that we are trying to do with it is to decrease its value in the coil as much as possible. There are several methods of decreasing the so-called *dead-end effects* in radio coils. The

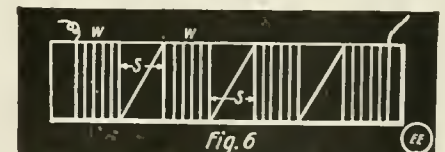

Radio Inductances Have Their Distributed Capacity Reduced by Winding the Coils in Groups, With a Space Between.

best and most practical way is to disconnect the portion of the winding which is not in use and this is what may be accomplished by employing a special switch arrangement on the coil. A highly ingenious switch which serves the purpose very nicely was described in the "Question Box"

(Continued on page 65)

AUXILIARY RELAY BREAK FOR COHERERS.

While the coherer is used but little in modern radio receiving sets, still, it is quite invaluable in making wireless demonstrations at lectures and for other radio control experiments.

One of the principal troubles developing in the operation of the filings coherer is that, it is so extremely sensitive to every

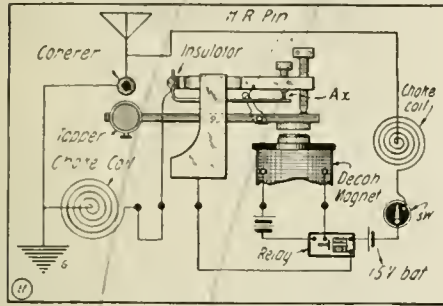

An Auxiliary Contact Fitted on the Relay of a Coherer Set Serves to Cut Off Local Oscillations from the Coherer.

little spark discharge in its immediate neighborhood and it is invariably found that the sparking at the relay contacts or at the decoherer contacts, will set up oscillations which will pass along the connecting wires of the coherer circuit and tend to act on it the same as an incoming wireless wave.

This trouble is overcome to a great extent by shunting the relay and decoherer contacts with high resistances, of the order of 2,000 to 4,000 ohms (wound non-inductively), and also by the insertion of choke coils in the lead wires between the coherer and main relay.

However, there is another scheme, not so well-known, perhaps, and which works very favorably indeed with the above purpose in mind. This consists of an auxiliary contact on the relay or decoherer, which so functions that the coherer circuit is opened as the relay or decoherer circuit "breaks," and thus the possibility of locally produced oscillations affecting the coherer are greatly reduced. Choke coils are not necessary with such an arrangement, but if used as an extra precaution, they can be made up of a fine, soft iron wire core 4 inches long by 1/4 inch diameter, wound with four layers of No. 26 gage insulated magnet wire, connected as shown in diagram.

USING "AUTO" SPARK COIL FOR RADIO.

This is a handy "hook-up" for those using an automobile ignition coil with three terminals, one of them being common to both primary and secondary. By using this connection scheme with an ordinary

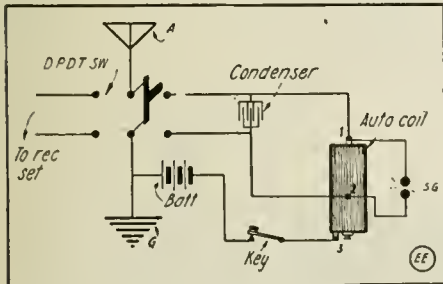

How to Hook Up an Auto Ignition Coil for Wireless Transmitting.

D.P.D.T. knife switch, it becomes impossible to press the key accidentally and knock the detector out of adjustment when receiving.

Be sure to connect that blade of the switch which connects with the common

terminal of the coil to the ground wires; otherwise a severe shock will be received if the uninsulated part of the key is touched while sending.

Contributed by
GEO. F. HARRINGTON.

SINGLE VS. MULTI-LAYER RADIO INDUCTANCES.

In the protection of radio frequency apparatus one of the most important points is the insertion of choke coils to localize properly the radio-frequency energy. I do not think it is as fully appreciated as it should be that multiple-layer coils are almost useless for this purpose, says Benjamin Liebowitz in the February, 1917, Proceedings of the Institute of Radio Engineers. Because of their large effective distributed capacity, radio frequency currents are propagated with great ease thru such coils, and often with disastrous results. Thus, in one instance, I employed as a choke coil an inductance of about 600 turns of number 18 B. and S. wire wound in 30 turns per layer, and burned out a generator in consequence. I replaced this coil by six single-layer spirals, about twenty-four inches (61 cm.) in inside diameter, of the same section. The six spirals in series had somewhat less inductance than the multiple-layer coil first used, but to currents less than 100,000 cycles in frequency they were an almost perfect barrier. It cannot be too strongly emphasized that distributed capacity is just as undesirable in choke-coils as it is in radio frequency circuits.

A "COIN" RADIO DETECTOR.

Wireless Bugs, try this on your detector. Procure a ten cent piece; if not handy try five cent piece. Put either of the coins in the detector cup and proceed to adjust for a sensitive spot, as you would with galena. If you are not satisfied with the results, try another coin.

The writer has experimented successfully with both coins, but prefers the DIME as it does finer work than the NICKEL.

(Evidently quality counts, for dimes are said to be more expensive than nickels!! Next!!!—Editor.)

Contributed by **WILLIAM MILLER.**

A SINGING SPARK INTERRUPTER.

Many amateurs, like that King of long ago, have muttered "My kingdom for a real musical spark," as they struggled with the stuttering, stammering interrupters usually attached to small spark coils. The mere note stamps them as beginners and the big fellows don't want to bother listening to the low-pitched code emitted from such stations.

But a great obstacle lies in their path in obtaining the oft wished for, high pitched note. Beside the mechanical difficulties there remains the fact that when the interrupter is speeded up, the range is shortened, due to the fact that the core of the coil does not become thoroly saturated with magnetism in the short time that the circuit is closed, with the result that the induced currents in the secondary circuit are not as powerful as they should be.

The interrupter described herewith does away with mechanical difficulties in a simple and effective manner, the only cure for the above mentioned condition being to increase the voltage of the supply current. By doubling the voltage very good results will be obtained with the following device.

The regular spring interrupter is removed from the spark coil and mounted on a conveniently sized base. Two uprights are cut from 1/4 inch square brass rod 4 inches long. Both ends of these rods are drilled and tapt for an 8-32 screw. One-half inch

A DRUM TYPE ANTENNA SWITCH.

Herewith is a diagram of an aerial switch for use in small stations. It is of the rotary drum type as seen. By referring to Fig. 1, it will be noted that the

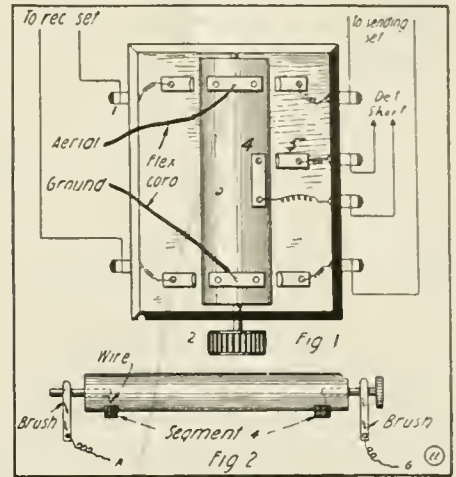

A Rotary Control, Drum Type Antenna Switch Is Easily Made on the Above Plan.

parts are numbered as follows: 1—binding posts; 2—electrose knob; 3—wooden cylinder; 4—brass segments on cylinder; 5—brass contact brushes; 6—box (wood or rubber 4x3x2 inches). The best job is made by using a hard rubber cylinder, supported on two small pins as shown at Fig. 2. The current for A and G is then carried thru the two shafts to segments 4.

Contributed by **HAROLD DAVIE.**

from one end of each rod a 1/8 inch hole is drilled to pass the two small round rods II H, as shown in the illustration. The square rods are mounted on the base as shown. The round rods put into place while screws, S S, clamp the latter in position.

The end of the interrupter spring is covered with small strips of mica held in place by thick shellac. This mica is to insulate the spring from the length of German Silver wire which passes under the spring and is wrapt around the two small brass rods as illustrated. The wire used may be No. 26 or No. 28 bare German Silver. The wiring under the base is shown in dotted lines.

To adjust, turn the vibrator screw all the way out to tighten the German Silver wire until it raises the spring slightly. Close the key and slowly turn the vibrator screw down till the desired note is obtained.

The operation depends upon the expansion and contraction of the wire which takes place at an unbelievably high rate of speed. The note obtained is very musical and in connection with the higher voltage in use, will increase the range of the set.

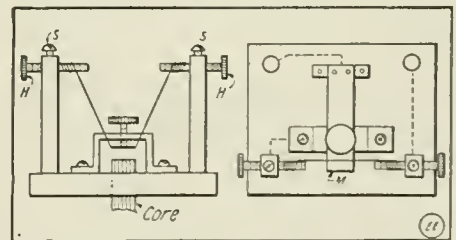

We All Desire to Have a High Note Spark. Here's How—A Piece of German Silver Wire Serves to Hold Back the Free End of the Vibrator Spring, Reducing Its Swing and Raising the Frequency.

It is advisable to renew the wire occasionally, as the heating crystallizes the molecules and after a certain length of time will refuse to respond.

Contributed by **THOS. W. BENSON.**

THE CONSTRUCTOR



An Electrical Paradox or Selective Lamp Controller

BY ALBERT H. BEILER

THE average person is always interested in a puzzle. When that puzzle is electrical, it is certain to appeal to the amateur experimenter. Can any of you think of an arrangement by means of which a single pole, single throw, knife switch may be made to operate three different lamps individually, during three successive inter-

A wooden cylinder, G, is fixed on A, which has brass segments fastened along its periphery as shown at E. It will be seen that E touches one of the brass strips I. This closes a circuit and lights a lamp. If some means could now be employed to move the wooden cylinder $\frac{1}{3}$ of a revolution, another segment seen slightly under the middle brass strip would touch the strip, while the

ratchet makes $\frac{1}{12}$ th of a turn, K will also turn $\frac{1}{12}$ th of a revolution. Thus the third of a revolution movement, which is necessary to bring each segment under its respective contact, is accomplished.

It is possible that the reader who has followed this explanation carefully will ask why the movement of the ratchet should be accomplished by the retractile spring T when the magnet exerts a greater force. In other words, why should not the segments change on the *down stroke* of the armature instead of on the *up stroke*? The answer is this: Suppose the commutator turned if a circuit was closed instead of when it was opened, then, for an instant the lamp would light which had just previously been lit. It is true that almost immediately it would go out and the required lamp would light but the result would very obviously be unsatisfactory. The time taken for the cylinder to commutate would be the time required for the magnets to pull the armature down. As this does not occur instantaneously, the above described result would occur. Another objection to having the commutator rotate on the down stroke of the armature is that a segment and a brass strip, each carrying current, would be separated from each other by the movement of the commutator and create a spark which would soon pit the segments and brass contacts and thus interfere with the satisfactory operation of the device. With the device arranged as just described the commutator moves an instant AFTER the circuit has been opened, thus preventing any arc from forming.

The wiring diagram is shown in Figure 8. B B B are the strips I of Figure 1. C represents the commutator segments. M is the electro-magnet. R is the rheostat, made of salt water with carbon electrodes, or sulfuric acid, and carbon or lead electrodes. Two 100 watt lamps in parallel may be connected in series with the magnet instead of the rheostat. The magnets must receive from $1\frac{1}{2}$ to 2 amperes, since they have quite a pull to make. The smaller circles B show where the wires from the device are connected to the binding posts seen in Fig. 1.

Anyone sufficiently interested may make one of these contrivances by following the diagrams and instructions which follow.

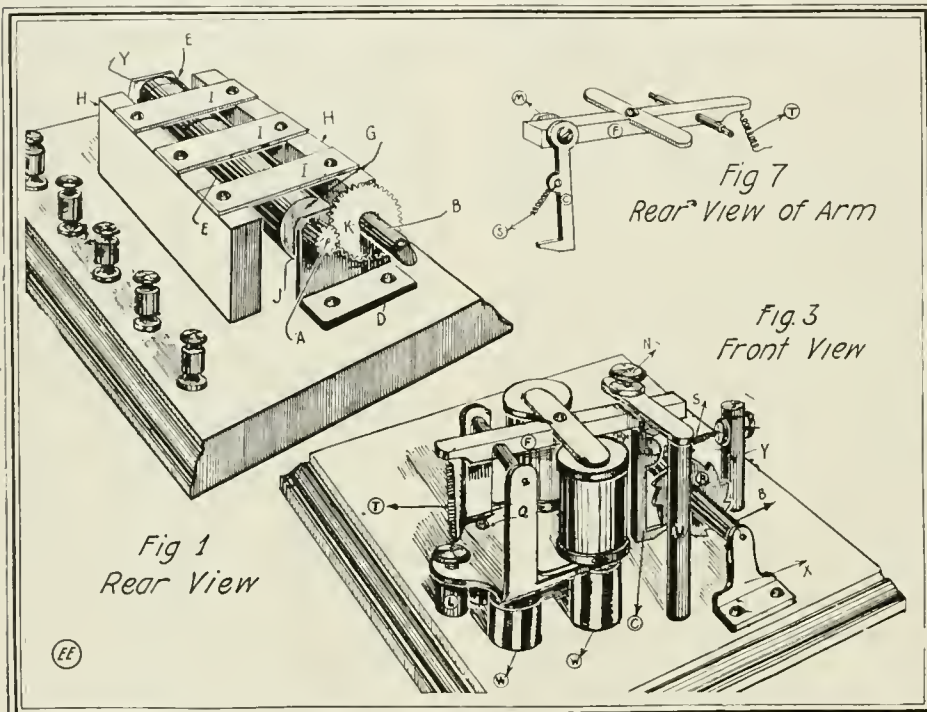

Perspective View of Selective Lamp Controller Built from a Telegraph Sounder, a Few Gear Wheels and Other Odd Parts. At the Left is Shown the Brushes and Commutator Unit with Gear Attachment for Rotating the Segment Drum.

vals that the circuit is closed? For example, if the switch is closed once, light No. 1 will light and remain lit until the switch is opened again. It will then go out. If the switch is again closed, light No. 2 ONLY will light and remain lit until the circuit is again opened. Similarly with light No. 3.

To secure the result described, an arrangement is employed somewhat similar to that used on the automatic block signaling systems of single-track electric railroads, and elsewhere. A commutator is made to move from one contact segment to another every time an electro-magnet draws its armature down (or up).

Referring to Figs. 1 and 3, when the circuit is closed, the magnets attract the armature, pulling it down. The hook C catches over a tooth of the ratchet wheel R. By noting the direction of pitch of the teeth, it will be seen that the movement of the hook will not cause the ratchet to move. The ratchet is rigidly attached to a shaft B, on which a gear wheel K is also firmly fastened (Fig. 1). This cog meshes with a smaller one, J, which is tight on shaft A.

first segment would have moved away from the end strip. Another third of a revolution would cause the foremost segment to touch the foremost I and close another circuit, while the other two circuits would remain open. When the switch is closed, the cylinder with the brass segments, called the commutator, will not move, but the hook will engage a tooth of the ratchet. Simultaneously a lamp will light. When the switch is now opened, the lamp will go out and the same instant the retractile spring T will pull the armature up again, since the magnets have lost their power of attraction. Hook C will pull the ratchet up a distance equal to its (the hook's) travel. This distance is such that the ratchet will have completed $\frac{1}{12}$ th of a revolution when the armature shaft F strikes its stop screw N. It must here be stated that the ratchet has 12 teeth, gear K, 48 teeth, while gear J has 12 teeth; the ratio between the two latter being 4 to 1. When the

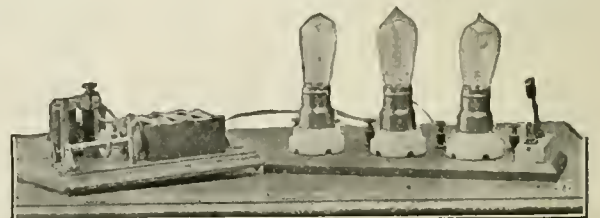

Photo of Selective Lamp Switch or Controller as Built by the Author, Together with Three Lamps to Be Controlled and Main Circuit Switch.

Secure an old telegraph sounder of the sort that is generally sold to amateurs for practising telegraphy. Unscrew the parts from the base and mount the frame, mag-

An Illuminated Stage Sulky

By HARRY S. TOWNSEND

SEVERAL years ago the author of this article had occasion to work up an illumination scheme for a small two-wheel sulky and harness to be used in a stage act.

Owing to the fact that the horse in this act performed many difficult tricks, with the result that the sulky was pitched at

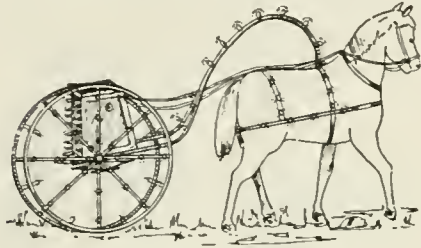

Appearance of Electrically Illuminated Stage Sulky and Harness.

many different angles and also for other reasons, storage batteries were not allowable. The scheme shown diagrammatically herewith was successfully developed and applied and the results were very satisfactory, particularly when the display of the illuminated harness and vehicle was shown on a darkened stage before black velvet drop curtains.

Briefly considered, the battery comprised 36 dry cells of standard size, connected in series-parallel to give 18 volts. The feed wires in the battery box, which was painted white to correspond with the trimmings of the balance of the vehicle and placed beneath the seat, were led to the various circuits about the sulky body and wheels and also to the harness.

The harness display consisted of a number of 16 volt battery lamps connected on parallel, the terminal wires ending in a separable connector, so that it could be instantly detached from the vehicle when desired.

A small switch placed in one of the main battery leads and arranged on the side of the seat frame, enabled the driver to switch on the lights at the critical moment when the stage had been properly darkened.

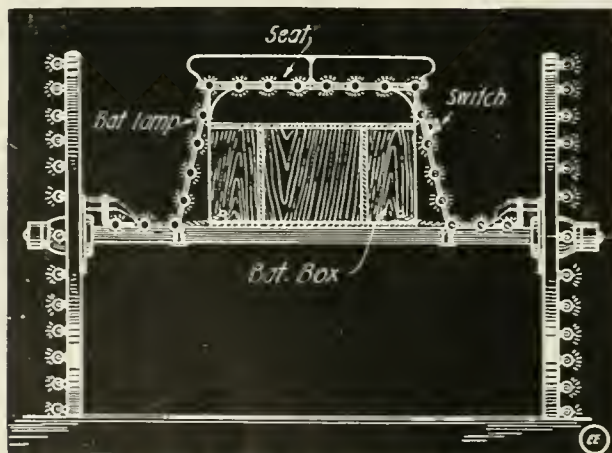

Rear View of Sulky Showing the Battery Box and Control Switch Within Easy Reach of the Driver.

One of the most difficult problems was to convey the current properly to the rotating lamp strips secured to the spokes of the wheels. This was accomplished by means of two brushes and a two ring commutator fitted to the side of each wheel.

The commutator disk was made of fiber and not more than 9 inches in diameter so

that it would be unnoticeable to those in the audience. The rear (facing the audience) side of the disk was painted white, the same as the wheels.

Three sixteen volt lamps were placed on every other spoke and several lamps were also secured to the fiber disk on its rear face so as to form a circle in conjunction with the inner lamps of the spoke strips. Lamps were also spaced in between, around the rims of the wheels, as seen in the illustration.

A detail of the round woven-wire brushes and brush holders is given in the illustration. The wiring was done with No. 14 rubber covered conductor for the main battery leads, and with No. 16 R.C. fixture wire for the independent circuits.

This arrangement, as will be observed by the reader, does away entirely with the nuisance of a trailing stage cable, which many electrical acts are burdened with. Altho not shown here, the various circuits were specially arranged so as to permit grouping into series—parallel on 110 volt lighting circuits when the occasion demanded. This required 4 contact rings and 4 brushes on each wheel, also a special disposition of the harness and vehicle circuits.

HOW TO MAKE CARDBOARD CYLINDERS.

Those radio-bugs who construct their own loose couplers and loading inductances are generally hampered by not being able to construct suitable forms on which to wind the wire. The following method I have found satisfactory and it takes but a few minutes to construct a serviceable tube of any desired size and thickness.

Having the plugs of the desired diameter ready, cut off a strip of thin cardboard slightly greater in width than the required length of the tube to be made. Now lay the cardboard on the table and proceed to roll the plugs. After making one revolution spread glue liberally over the remaining part and finish rolling it up. If the tube is not as thick as desired, another strip of cardboard can be wound over the first. It is well not to have the tube fit too tightly over plugs,

or trouble will be experienced with shrinkage during further treatment. The tube is now wound with tape or cord and placed in a moderately hot oven for fifteen minutes or more.

After removing from oven, trim edges carefully and while still hot give it a thoro coating of orange shellac inside and out. While the shellac is still fresh, take your blow torch and with a sweeping movement burn the shellac into the tube and repeat the process. It is well to make sure you are using pure shellac, not cheap glue, as some so-called shellacs are (I make my own shellac out of orange shellac flakes dissolved in grain alcohol). If you do not have a blow torch handy, a good heating in the oven will do altho it requires more time.

The appearance of the tube is greatly improved by blackening the ends. A thin paste made up of black aniline dye, dissolved in white shellac, gives a glossy black. A black looking luster can be made of lamp-black mixed with orange shellac. The for-

mer is preferable, having better insulating qualities than the latter.

A little experience in tube making will soon make you proficient in the art. At a

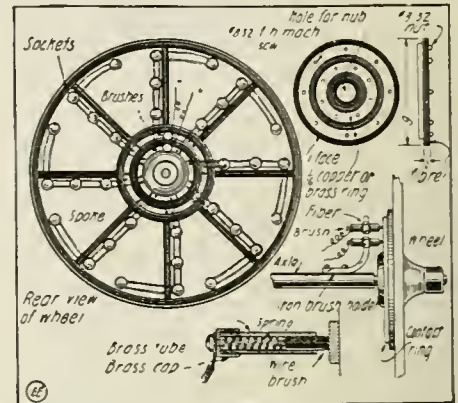

Details of Sulky Wheels and the Metal Contact Rings and Brushes Whereby Current is Conducted to the Lights on the Spokes.

small cost moisture proof tubes can be made quickly, saving valuable time in waiting.

Contributed by

CHARLES M. FITZGERALD.

HOW TO FROST LAMPS QUICKLY.

Take the bulb and smear over thoroly with a good library paste; after which dip into a cup of sugar or salt crystals. Then let stand for awhile. Do not use glue for an adhesive as this has a tendency to dissolve the salt or sugar.

Contributed by JOHN T. DWYER.

TO USE OLD BATTERY ZINCS.

When the lower half of a battery zinc is eaten away by the action of the electrolyte, the remaining portion can be utilized by suspending it from a wire, so that the zinc is covered by the battery solution.

A very good electrical connection should be made between the wire and the zinc and the joint covered with melted paraffin. This

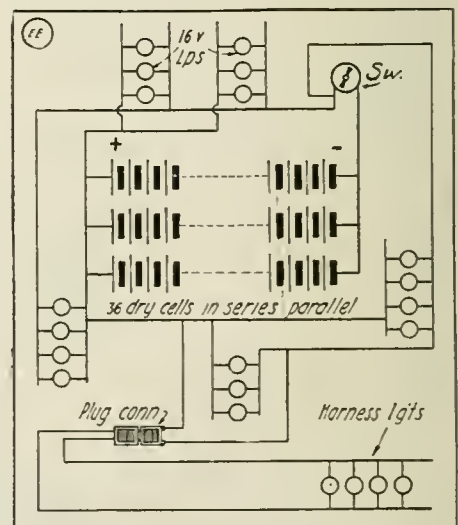

Wiring Diagram for 36 Dry Cell Battery and Various Lamp Circuits on the Sulky and Harness.

last precaution is necessary as otherwise corrosion would soon occur from the action of the salammoniac or other chemical. The wire may be held at the top of the jar by twisting around a small piece of wood.

Contributed by K. M. COGGESHALL.

UNIQUE INDICATOR SYSTEM WHICH ANNOUNCES THE ICEMAN AND GROCER.

A "step-saver"—that's just what this device is, for, when constructed, it will save Mother or the housekeeper many a fruit-

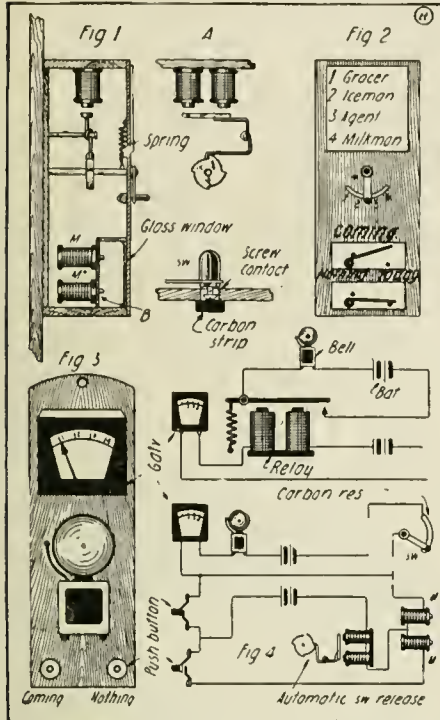

The Women Folks Need Not Run to the Door for the Iceman and Grocer, When This Apparatus Is Installed. The Tradesman Turns the Switch Lever to the Proper Number; the Kitchen Indicator Shows Who Is Calling and the Cook Pushes the Button Marked "Coming" or That Labeled "Nothing To-day."

less trip to the door in response to the ever-ringing bell, because it enables her to know *who is calling*, whether the milkman, baker, etc., and signal to them if their goods are needed or not—all without requiring any more effort on her part than merely pushing a button.

The first thing required is a wooden frame or case, similar to that shown in Figs. 1 and 2. Inside of the same are arranged the indicator magnets and also the magnets controlling the automatic switch release (A in Fig. 1). This latter may be simply the armature and taper rod of an ordinary battery bell, bent as illustrated in order to allow the extremity to act as a check pawl on the four-cam wheel, which is centered on a shaft manipulated by the switch handle. It will be seen that this prevents the switch, when once set at the point desired, from falling back to its original position after pressure has been removed. The cam wheel, if not procurable from old clock works, can be easily turned out of wood by a jig saw or of brass in a lathe. By the same methods any other parts of this device may be constructed when lack of simpler means prevents otherwise. The carbon strip (another form of resistance may be used if this is not handy) can be cut out from the carbon electrode of an old battery cell and should be placed on the inside of the box directly over the groove, by means of which the switch makes contact with it. The partition B, in Fig. 1, should have two holes for the insertion of the core ends of the electromagnets M' and M'', which, on being actuated, raise up one or the other gravity indicators, Fig. 2. These latter are merely short lengths of steel wire bent as shown, so as to allow them freedom of motion up-

wards. As can be seen one is for the purpose of signaling to the waiting tradesman that the housekeeper *is coming*, while the other performs an *opposite* function, as the case may be.

Fig. 3 shows the *indicator* panel proper, which includes simply a low resistance galvanometer or ammeter, two push buttons, and a bell. If the reader cannot make such an instrument, he will find an admirable one described in the *August* issue of the "E. E." Of course, it is understood that the scale card is not marked off in amperes but instead into four divisions, numbered from one to four—each division representing the title of such tradesmen as call most frequently. The *front door device* is also marked with corresponding numbers (see Fig. 2) and a printed card like that shown should be placed on it. It will be necessary to experiment for a while in order to have these numbers correspond; that is to say, when the switch is turned to *Grocer*, which is No. 1, the resistance traversed must be such as to move the needle on the indicator also to No. 1. Full electrical connections are shown in Fig. 4.

Assuming that everything has been completed, let us suppose the *Milkman* comes and turns the switch to No. 4. Such action allows more or less current to flow with the result that, at the same time the bell is rung, the indicator needle is turned also to No. 4 and all the lady of the house need do is glance at the same to ascertain that fact. If milk is not wanted, she has only to push the button designated—*Nothing To-day*. The current set up actuates the electro-magnet controlling the lower signal and the latter is raised upwards, thus acquainting the tradesman with the fact that his goods are not required. At the same time, it will be noticed by following out the electrical diagram carefully, that the armature of the switch return mechanism is attracted upwards, thereby releasing the check pawl and allowing the switch (which has a coil spring exerting tension upon it) to resume its original position. The device is then ready for the next caller.

Contributed by JOHN T. DWYER.

[Editor's Note:—We would suggest the use of a low resistance relay in place of the vibrating bell, the local circuit of the relay being connected to a bell and battery. This permits the action of the INDICATOR system to be much more even and accurate. This change in the layout is shown in supplemental diagram Fig. 4.]

AN EXPERIMENTAL SPARK COIL.

I have just completed a small "spark coil," of my own design, which embodies a special feature of regulation. The full strength of this coil, when the primary is all the way within the secondary, is 1/2-

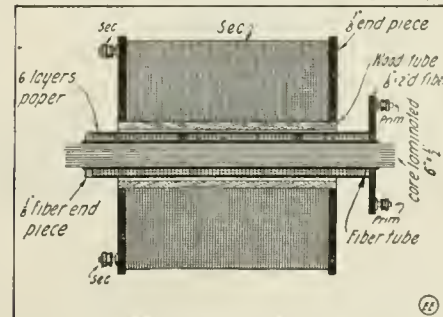

This Experimental Spark Coil Has a Removable Primary Coil and Core, So That All Sorts of Experiments Can Be Tried With It.

inch heavy spark, and the minimum strength is "0," when the primary is drawn all the way out.

The drawing explains all details. The primary is made separate and complete from the secondary with binding posts at-

HOOK-UP FOR STARTING UP TWO MOTORS WITH ONE RHEOSTAT.

Emergency making necessary the use of limited equipment for connecting up two 10 horsepower direct current shunt field motors, with one starting box, I made use of the hook-up herewith reproduced to start up each machine and connect it on the main line.

The first step was to provide ample pro-

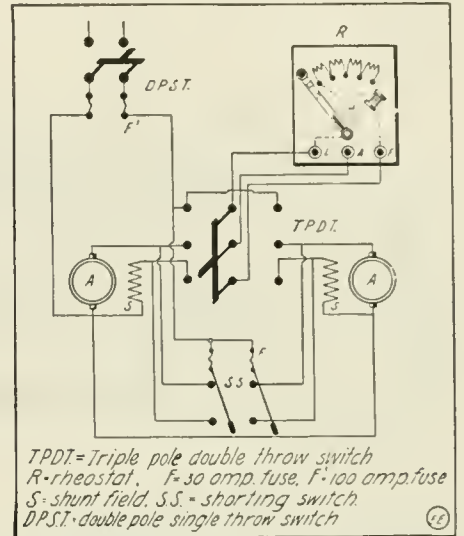

TPDT=Triple pole double throw switch
R=rheostat, F-50 amp.fuse, F'-100 amp.fuse
S-shunt field, SS=shorting switch
DPST=double pole single throw switch

Useful Kink Utilizing One Starting Rheostat for Starting Up Two Motors. After Each Motor Has Been Accelerated in Turn, the Proper Switch Is Closed, Throwing It Directly on the Line.

tection against overloads and failure of power, which was overcome by properly fusing as per diagram.

With T.P.D.T. switch in neutral or straight out position, connections to the motor are broken. Throw main switch in, then T.P.D.T. to either side to start respective motor. Bring rheostat lever up slowly to no-voltage release and lock; next throw in respective shorting switch, when handle on starter should drop, thus connecting one motor on the line.

To start the second motor, throw T.P.D.T. switch to opposite side and start as before, after which close the proper shorting switch. Both motors now on the main supply line; pull T.P.D.T. switch to neutral position.

I have had entire success in running both motors by this method for a period of 30 days, depending exclusively on the 30 ampere fuses for overloads and manually opening the circuits in case of generator shut-down or cutting off of the power.

Contributed by RAY J. BUTTON.

tached. The secondary is wound upon a spool, which also has binding posts attached.

The primary unit comprises an iron wire core 6 inches long by 1/2 inch diameter. The primary winding is of two layers No. 18 D.C.C. magnet wire. This is covered with several layers of waxed paper. The primary terminals are mounted on a fiber disc, 2 inches diameter, as shown. The completed primary is soaked in molten paraffin wax. The secondary coil consists of 1 1/4 lbs. No. 34 S.C.C. magnet wire, wound in layers onto a wooden or fiber spool, measuring 4 inches in length. The starting or inner lead of the secondary should be well insulated by passing thru a glass or rubber tube outside the spool or else by passing it thru a hole drilled radially down thru the spool cheek, this one being made 1/4-inch thick or more for the purpose.

Contributed by CHAS. S. PORTER.

A Simple Electric Motor Attachment for Phonographs

By R. U. CLARK, 3rd

THE phonograph is without doubt one of the greatest of all pleasure giving instruments. This fact is amply demonstrated by the large number of these machines in use at the present time. It is, however, like many other articles, appreciated most when new, and is little used

at a constant speed by the governor with which the talking machine is fitted, may appear rather inappropriate, but, altho some heating does take place in this motor it is not sufficient to cause excessive wear or shorten its life materially.

The actual method of driving the talk-

motor, but does not effect the *speed governing* mechanism, which is left in place, for use with the electric motor, to control the speed in the usual manner.

After disconnecting the spring motor from the turntable shaft, the table should be removed and a small groove from 1/32 to 1/16 of an inch deep, the actual depth depending on the thickness of the turntable rim, should be made for the belt to run in around the outside of the rim. This groove should be about 1/8 of an inch wide, and should not be too near the top edge of the rim. On certain machines there is a narrow shoulder located under the rim, which in some cases will hold the belt.

As the phonograph is to be driven by a belt a small grooved pulley wheel for the motor is necessary. This wheel is best made of metal with a small groove about 1/8 inch wide, either V or semi-circular in cross-section, and about 1/16 inch deep. The greatest diameter of the pulley should be about 1 inch or under. The author has used experimentally several sizes from 5/8 inch up to 1 inch, all with considerable success, but when a 1 inch wheel is used, the motor which then turns at about 800 r.p.m. seems to run the quietest, and with practically no belt slippage. Within the sizes mentioned the diameter of the pulley will have little effect upon the speed of the turntable, which is still controlled by its own governor as mentioned above, but of course the motor pulley-belt speed will be decreased by the use of a small pulley and increased when a large pulley is employed. A 10 cent pulley from a mechanical toy set is satisfactory.

The method to be used in mounting the motor will necessarily depend somewhat upon the type of talking machine used. There are two simple ways of attaching the motor, one of which should be applicable to nearly any machine made. Whenever the construction of the talking machine permits, the motor can be hung out of sight, from the top-board of the body of the phonograph, with the shaft extending thru this board about 1/2 inch, so that the pulley wheel can be mounted with ease from the top side of the board on which the motor is hung, as shown in Fig. 1. This mode of mounting is possible only with a certain class of phonographs, mostly the larger sizes. For use with small machines, where the motor cannot be hung out of sight, it can be inverted and fastened to the top board, in such a manner that the pulley groove, which comes next in position to the motor bearing, with the hub near the outside end of the shaft, comes in line with the grooved portion of the turntable. (See Fig 2.)

To use the method of attachment first

after its novelty wears off, owing to the constant attention required to operate it. Winding up the spring to keep the motor going is the one thing which detracts most from the pleasure which should be derived from any good talking machine.

By means of a simple electric motor attachment it is at once possible to do away with practically all the bother incident to the operation of the talking machine, with the exception of changing the records.

Most of the standard machines on the market today lend themselves very readily to the attachment of an auxiliary motor device, so that, by the employment of a little care and ingenuity, it is a simple matter to remodel a phonograph so as to run it by electric motive power.

The actual amount of power required to drive the turntable of most any phonograph at the proper speed is very small, although it may not appear so to the person who has to be continually winding up the ordinary spring motor. Just how little power will suffice depends more or less on the machine to be driven, but for most machines a universal electric motor of 1/40 H.P. will be found quite sufficient. These motors can be purchased new in most cases for as little as \$4 complete, and can be attached by a flexible wire direct to the ordinary lamp socket, without using any extra resistance. The motor used by the author with considerable success was bought originally as a fan motor for \$4; the fan, guard, and base which came with the motor were removed.

The motor mentioned above was designed to drive a six-inch fan at about 3,000 r.p.m. Under this load the makers claim it can be run at a cost of about 1 cent per 6 hours, the rate per K.W. being 10 cents. This motor is equipped with special patented bearings which require no oiling; for about 2 months, during which time the author's machine has been run a great deal, no oil has been placed on the bearings.

The use of such a small motor, as mentioned above, for such exacting work as running a large turntable, which is held

ing machine turntable on which the records rest, as described in this article, is by direct belt connection, which method requires perhaps the least accuracy in construction. The author after considerable experimenting with a simple friction drive, direct from the electric motor shaft, which was fitted up with various rubber and composition friction wheels, was forced to give up this method in the favor of belt drive. Friction drive applied to such a mechanism as the phonograph requires very accurate construction, and even then direct friction drive on most machines would prove noisy and unsatisfactory, due to the notoriously imperfect, peripheral arc described by most talking machine turntables.

The first step in the preparation of the talking machine for the addition of an electric motor is to run the machine until the spring is completely unwound. This requires about fifteen minutes time. The spring motor and top board is then removed temporarily from the phonograph, if possible, by removing the crank handle.

In some machines it is possible to get at the motor from the bottom. As soon as access to the motor is obtained, the gears and shaft, which form the connecting link between the turntable shaft and the spring motor gears are removed. The unit to be removed is clearly indicated in Fig. 1, A—A. The heavy center line A—A which passes thru the lower part of the spring motor casing indicates the position of the unit to be taken out. Removing this piece, by letting up on the set screws, which hold the pivot bearings, on which the shaft mentioned above runs, simply disconnects the turntable and its shaft from the spring

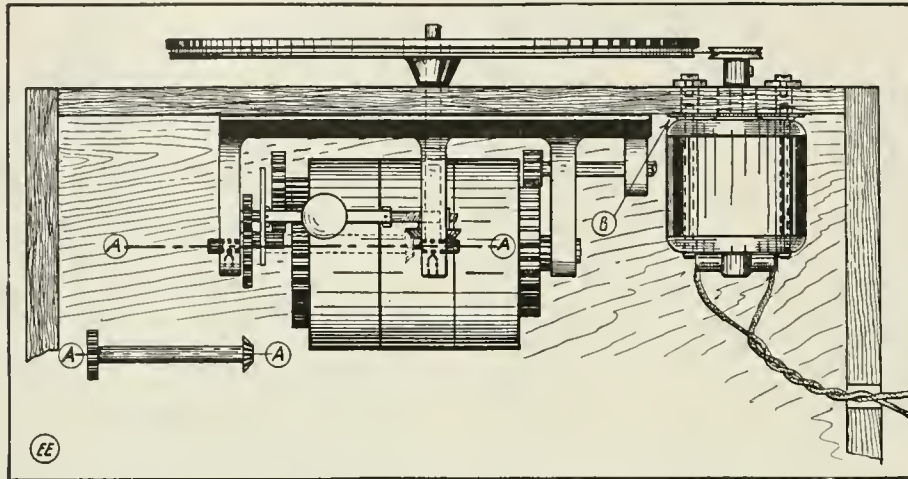

Illustrating How the Author Devised a Simple and Effective Electric Motor Drive for a Disc Style Talking Machine. The Old Governor Mechanism is Retained and the Motor Drives the Record Table by Means of a String or Cord Belt. (Fig. 1.)

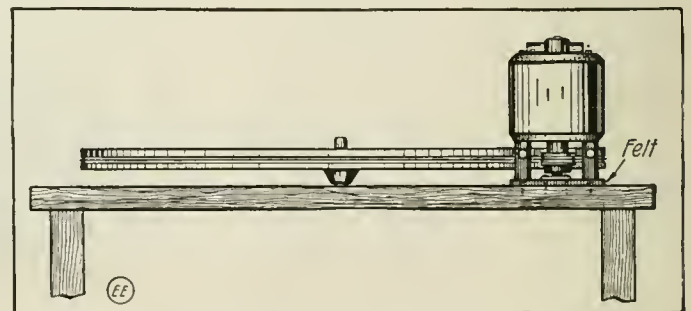

Where It is Not Possible to Conceal the Motor in the Cabinet, as in Small Machines, the Motor Can Be Readily Mounted Above the Cabinet Shelf as Shown. (Fig. 2.)

described it is necessary to drill three holes in the top board spaced about 2 inches from the edge of the turntable. The center hole is made to accommodate the main bearing and shaft of the motor. The

(Continued on page 76)

HOW TO MAKE IT

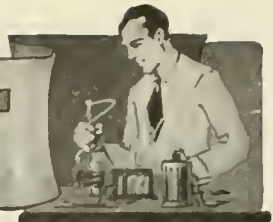

This department will award the following monthly prizes: **First Prize, \$3.00; Second Prize, \$2.00; Third Prize, \$1.00.** The purpose of this department is to stimulate experimenters towards accomplishing new things with old apparatus or old material, and for the most useful, practical and original idea submitted to the Editors of this department, a monthly series of prizes will be awarded. For the best idea submitted a prize of \$3.00 is awarded; for the second best idea a \$2.00 prize, and for the third best a prize of \$1.00. The article need not be very elaborate, and rough sketches are sufficient. We will make the mechanical drawings. Use only one side of sheet. Make sketches on separate sheets.

FIRST PRIZE, \$3.00

A VOLTMETER FOR THE AMATEUR ELECTRICIAN.

Herewith is described an easily constructed voltmeter, which will accurately register.

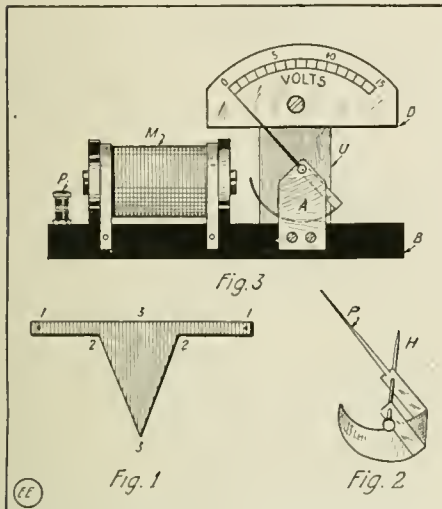

A Simple Voltmeter for the Student, Comprising an Electro-magnet and a Pivoted Piece of Sheet Iron With an Indicating Needle Attached as Shown.

if properly constructed and adjusted. It is very simple and requires few materials, all of which are found around the experimenter's shop.

The base was made 5 by 1½ by ½ inches. The upright U was made from the same material 1 inch shorter. Next I cut out a piece of tin from a cocoa can in the shape shown in Fig. 1; 2 inches from 1 to 1, 1 inch from 2 to 2 and 1½ inches from 3 to 3. Two small holes are put one in each end. Then I bent it into the shape shown in Fig. 2, over a hammer handle. The pointer P was made from a piece of fine wire and soldered on. A large pin served as an axle, H. The piece of tin A, Fig. 3, holds one end of the pin while the other end is driven into the upright, U. The magnet M was taken from an old bell and held in position by tin strips as shown. After putting the upright and disk into position, the instrument was complete.

The best way to mark the disk is with a transformer: mark where the pointer stays in a natural position with an O. Then connect five volts to the binding posts and mark where the pointer stays with a 5. Do the same with ten and fifteen volts. Mark off spaces of one volt each between the numbers. This instrument will be an interesting as well as useful addition to the shop for measuring various voltages.

Contributed by FRANK M. JACKSON.

GOLD LEAF SUBSTITUTE FOR ELECTROSCOPES.

Coat lightly one side of a piece of tissue paper with lamp black and turpentine

SECOND PRIZE, \$2.00

USING COMMUTATOR FOR WIND DIRECTION INDICATOR.

Many people find an electrical wind direction indicator both useful and practical. It is very convenient to have such an installation in the home, office or laboratory, so that by simply glancing at the electrical annunciator, one may know just how the wind is blowing, so far as its direction is concerned.

Most of those described in the "How-To-Make-It" columns of electrical journals, involve the construction of a commutator or segmental switch. This difficulty is readily overcome by utilizing a small size motor commutator, which can be purchased at little cost from any electrical supply house or dealer, and having eight or more segments.

The commutator is made stationary on the shaft standard supporting the weather vane, while the moving lower part of the device attached to the weather vane proper, carries at its lower end an electrical contact brush (preferably a rolling ball or wheel contact) which of course will turn with the vane.

The moving part of this apparatus should not be too stiff, and the best ones now in use are equipped with ball bearings. With a little ingenuity on the part of the builder, it will be found possible to incorporate the ball bearing feature with very little trouble, and the vane will be many times more accurate and reliable than the ordinary one. The circuit connections between the moving brush, commutator and flash lamp annunciator are shown.

Contributed by PETER BROWN.

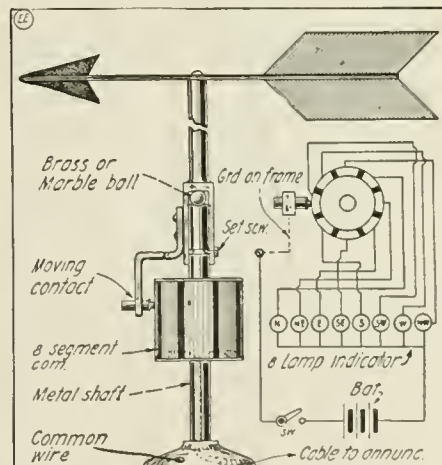

Many Experimenters Desire to Build an Electrical Weather Vane. But Hesitate to Do So, Owing to the Difficulty in Constructing a Suitable Multiple Contact Switch. A Motor Commutator Solves the Problem.

with a brush. Cut a 2½x1¼ inch piece from it for your electroscopes. Electroscopes may be used to test insulators.

Contributed by CLARENCE MELOTZ.

THIRD PRIZE, \$1.00

WHAT IS A SAFE RETREAT DURING A THUNDERSTORM?

Place a mouse, a bird, an electroscope and some gunpowder inside a wire gauze cover, such as is used for protecting meat.

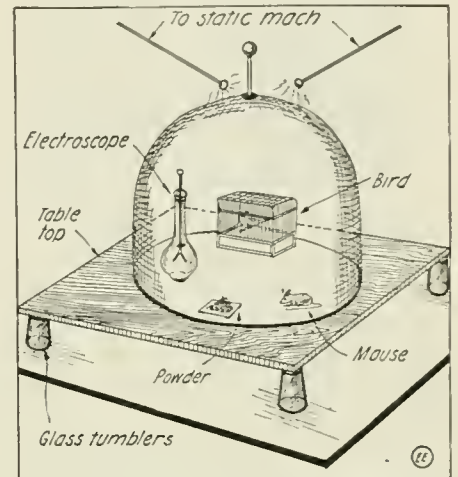

To Prove That a Person is Invariably Safe from Lightning When Inside a Metallic Cage, Mr. Weinbrot Places Some Powder, a Mouse and a Bird Within a Metal Cage. Heavy Static Sparks Jumping to the Cage from a Wimshurst Machine Have No Effect on Any of Them.

The whole, being placed on a board is supported on four warm, dry tumblers placed on the top of a table.

Connect it with a static machine and set it working. Altho an abundance of sparks may be made to play all over the outside, the living things, the gunpowder and even the electroscope will not be affected in the least.

From this experiment one may therefore deduce that the safest place in a thunderstorm is in the metal lined meat safe, provided, of course, that it is large enough. This also demonstrates the theory of Lodge regarding the design of lightning rods for protecting buildings. Lodge recommends for first-class protection that the edifice should be entirely enclosed under a perfect network of wires, resembling in effect an ordinary bird cage. Modern installations of lightning rods follow this theory as nearly as possible. The important part to bear in mind is, that you should not touch the metal, otherwise fatal results will occur.

Contributed by E. F. WEINBROT.

FROSTING GLASS WITH BEER.

Secure ½ pint of lager (light or dark) beer, and to this add enough epsom salts, so that when stirred up it will be the consistency of cream. Apply this cream to the glass to be frosted with a sponge. This frosting will not readily wear or rub off under any conditions.

Contributed by EUGENE RUCKMAN.

HOW TO KNOW WHEN TOOLS ARE RETURNED.

Every experimenter knows that people who come in and borrow tools never, by

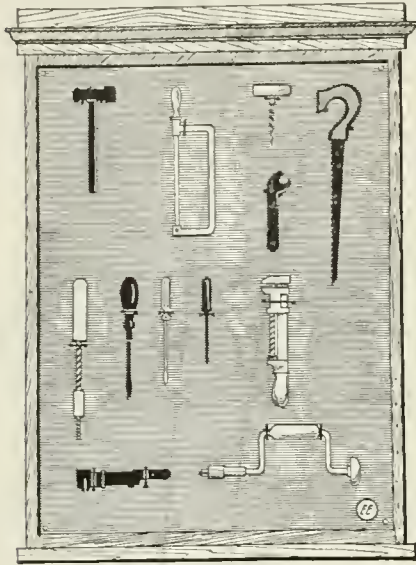

To Tell at a Glance Whether or Not a Certain Tool Has Been Returned, Simply Paint Its Outline in Black or White on a White or Black Board as Shown.

any chance, replace them in their proper place.

The accompanying illustration shows a very simple method of overcoming this annoyance. The outlines of the tools are painted in white or black on the cabinet wall in the positions which the tools normally occupy. When this is done a person has only to glance at the cabinet and can tell immediately just where each tool belongs.

Contributed by
AN EXPERIMENTER.

A SOUND OPERATED MOTOR.

Take any telephone transmitter and remove the carbon granule cup, solder a platinum point to any metal piece and fasten in place of the granule cup. Solder a platinum point to the center of the diaphragm. The two platinum points should be as near each other as possible without touching. The battery motor is equipt with a wooden block fastened to the axle shaft. A mirror can be fastened on either side of the block. A beam of light can thus be reflected, which should prove interesting to those experimenting with sound waves. The motor and transmitter are placed in a circuit with a battery.

Any word spoken into the transmitter

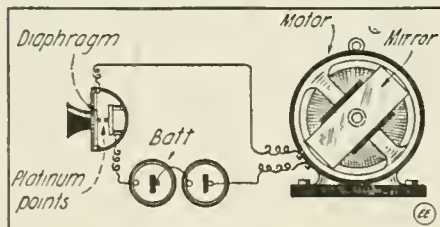

Novel Scheme for Controlling Revolving Mirror by Means of a Microphone.

will vibrate the diaphragm, and cause the motor to spin around at different speeds, according to the words spoken.

Contributed by LEE A. COLLINS.

PRACTICAL HELPS FOR THE AMATEUR.

Repairing Dry Cell Terminals.—A simple method is to solder a 6-inch length of flexible wire to the zinc container of the dry cell for making connections. If a binding post is necessary, solder a spring binding post in place as shown. In emergencies paper clips may be used, bending as shown and slipping wire into them.

Shocking Machine from Alarm Clock.—Since a clock is generally used as an interrupter best results can be obtained by arranging a spring to press against one of the wheels which revolve at fairly high speed, when the balance wheel is removed. A higher rate of interruption results, giving a constant tingle instead of a series of jerks. The spring and gear are connected in series with two handles, an electromagnet and two to three dry cells.

Simple Time Signal.—The relay and resistance shown in a previous issue of this journal may be done away with by simply rewiring the time ball solenoid and horn as shown herewith. This likewise does away with an extra set of batteries. Key B operates the electric horn and A controls the semaphore.

Removing Enamel from Magnet Wire.—The easiest method is to use an ink eraser for this purpose. The wire is cleaned quickly and perfectly without excessive abrasion. To do this easily, slit one end of the eraser and run the wire thru the slit several times.

Fuse Clips.—This fuse is in the same class as the above hints, being made from

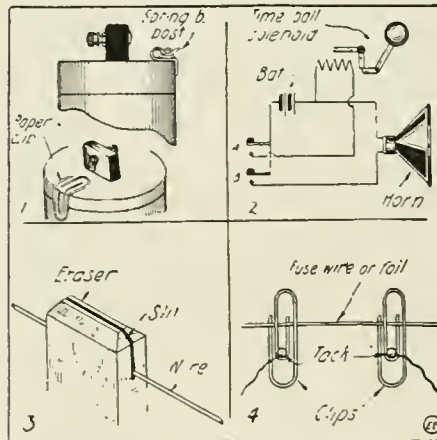

Some Handy Kinks for the Experimenter.

paper clips. Fasten to board with screws or tacks and slip fuse wire, fine copper wire or tinfoil under clip.

Contributed by T. W. BENSON.

A CLEVER USE FOR SPEED INDICATORS.

In constructing a metal pattern recently in order to determine the amount of metal needed for a wall, it became necessary to find the perimeter of a figure similar to that shown in Fig. 1. The work was held up until a way of doing this could be found. I at last thought of the following device:

A brass wheel, 3/4 inches in diameter, was soldered on the shaft of an "Electro" Speed Counter as shown in Fig. 2. The counter was then grasped in the hand and the wheel was run around the edge of the design. The diameter of the wheel was multiplied by 3.1416 to obtain the circumference of the wheel, which was then multiplied by the revolutions shown on the indicator. This gave the distance around the figure. The size of the wheel can of course be altered to suit different conditions.

Contributed by J. C. GILLILAND.
[Editorial Note:—Another useful dodge

A HANDY HEIGHT GAGE.

The sketch gives dimensions for making this useful height gage. The micrometer head is of Brown & Sharpe make and will give a forced fit in the .374" hole. It will be necessary to anneal the spindle end to tap a No. 3-48 thread, so as to hold the

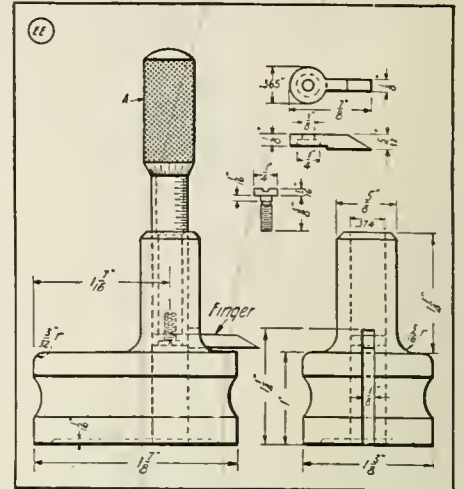

An Effective Precision Height Gage May Be Constructed from a Standard Micrometer Head Fitted in a Steel Base of the Dimensions Indicated.

finger shown in detail at the right, also the screw. The bottom surface of the base is undercut 1/16 leaving a 3/16 foot all around.

Harden the finger, screw and base, and when finger is attached to spindle it is moved all the way to zero on barrel; that is, when tapping, base and finger are together, the micrometer head is set at zero, all moving parts having a free sliding fit with no shake.

This gage has one advantage over the great number of other height gages in that you can scratch a line from O to any reasonable dimension.

Contributed by JAMES McINTYRE.

in this direction consists of making a brass wheel as shown at Fig. 3, having a small groove in its periphery; in this groove is placed (glued) a rubber band which is slightly smaller than the wheel. Knowing the dimensions of this wheel and noting the revolutions on the dial, it becomes an easy matter to measure railroad lines, state border lines, conduit and pipe runs on blueprints, et cetera, by simply rolling the wheel along these lines. In one of these devices which we used some time ago, the wheel was made so as to have a circumference of 5 inches, or a maximum diameter of about 1 5/8 inches. The diameter multiplied by 3.1416, gives the circumfer-

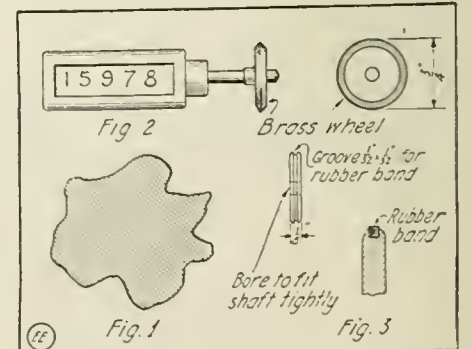

Attachment for a Speed Indicator Making It Available for Measuring the Perimeter of Irregular Surfaces, Map Routes, etc.

ence and the latter term, divided by 3.1416, gives us the diameter.]

Experimental Chemistry

By ALBERT W. WILSDON

Twelfth Lesson

ACIDS, BASES, AND SALTS.

IN this lesson we shall take up the study of the various acids and characteristics. These form one of the most important studies in the realm of chemistry. A resume of the general properties of acids are briefly as follows:

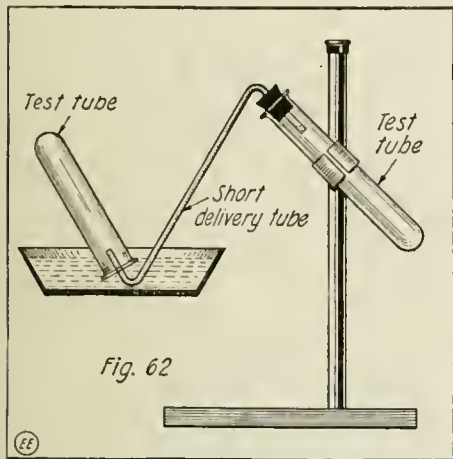

Fig. 62

How Apparatus Is Arranged in Experiment of Collecting the Product of Acetic Acid.

1. An acid is a substance composed of hydrogen and a non-metallic element or radical, the hydrogen being replaceable by a metal or a group of elements equivalent to a metal. The fact that hydrogen is a constituent of all acids, explains why they are sometimes called *Salts of Hydrogen*.

2. Acids usually have a sour taste.

3. If soluble in water, as most acids are, they turn blue litmus paper (or solution) red. They also change the color of many vegetable substances.

4. They react readily with a base to form a salt and water.

5. They react readily with some metals to form salts, liberating hydrogen.

6. Most acids are soluble in water.

7. They also have the power to decompose most carbonates, like limestone, liberating carbon dioxide which escapes with effervescence.

The common acids are:

Hydrochloric (HCl); Nitric (HNO₃); Sulfuric (H₂SO₄); Acetic (C₂H₃O₂); Oxalic (H₂C₂O₄); Tartaric (H₂C₄H₄O₆) and Citric (C₆H₈O₇);

Of these common acids, Hydrochloric is a gas (the Hydrochloric or Muriatic acid of commerce is only the gaseous acid in solution); Sulfuric and Nitric acids are liquids; while Oxalic, Tartaric, and Citric acids are solids.

To illustrate the many familiar substances which are acids or contain them, we will take the following few:

Vinegar, Pickles and Relishes, when Acetic acid is present, attributes to the agreeable sour taste.

Vinegar is simply a dilute solution of acetic acid, containing coloring matter and other substances, obtained by the acetous fermentation of poor wine or wine residues, of beer which has turned sour, and of other dilute alcoholic liquids.

The sourness of fruits being due to the presence of citric acid, as in the lemon, apple, currant, raspberry, gooseberry, etc.

During fermentation many acids are formed, as in the case of sour milk, lactic acid is present

Soda water is a solution of Carbonic acid (Carbon Dioxid), and acid phosphate is a solution of a sour calcium phosphate. Mineral waters frequently contain Carbonic acid.

Hydrochloric acid is present in the gastric juice of the stomach, and performs an important part in the process of digestion.

From the above we can see that many acids are of importance, and many are used by us every day in some form or other. We can, therefore, see that all acids are not to be scorned as dangerous, as doubtless many readers of this article have heretofore believed, when the word acid was mentioned.

NOMENCLATURE OF ACIDS—

Oxygen is a component of most acids, and the names of these acids correspond to the proportion of oxygen which they contain. The best-known acid of an element usually has the suffix *-ic*, as Sulfuric, Nitric, Phosphoric. If an element forms another acid containing less oxygen, this acid has the suffix *-ous*, as, Sulfurous, Chlorous, Phosphorous. Some elements form an acid containing less oxygen than the *-ous* acid; these acids retain the suffix *-ous*, and have, also, the prefix *Hypo-*, as, Hyposulfurous, Hypophosphorous, Hypochlorous. The prefix *Hypo-* is derived from the Greek word, meaning lesser or under. If an element forms an acid containing more oxygen than an *-ic* acid, such an acid retains the suffix *-ic* and has, also, the pre-

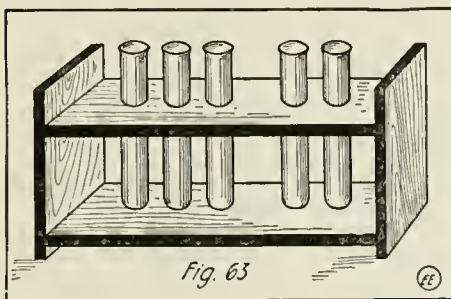

Fig. 63

In Conducting Experiments With Various Acids it Will be Found Convenient to Place the Test Tubes Containing the Acids in a Wooden Rack. The Tubes May Be Suitably Labeled.

fix *Per*, as, Persulfuric, Perchloric. The Latin prefix meaning beyond or over. The few acids which contain no oxygen have the prefix *Hydro-* and the suffix *-ic*, as, Hydrochloric, Hydrobromic, Hydrofluoric. It should be noticed that these suffixes are not always added to the name of the element, but often to some modification of it.

Acids having the prefix *Hydro-* and ending in *-ic* form salts with names ending in *-ide* and having no prefix.

All other acids with names ending in *-ate* form salts with names ending in *-ate*. [Final "e" dropt in simplified spelling.]

All acids whose names end in *-ous*, form salts whose names end in *-ite*.

ACIDS AND THEIR SALTS.

- Hydrochloric acid, HCl; Form Chlorids, NaCl; Sodium Chlorid.
- Sulfuric acid, H₂SO₄; Form Sulphats, CuSO₄; Copper Sulphat.
- Nitric acid, HNO₃; Form Nitrats Pb[NO₃]₂; Lead Nitrat.
- Sulfurous acid, H₂SO₃; Form Sulphits, K₂SO₃; Potassium Sulphit.
- Hydrobromic acid, HBr; Form Bromide, AgBr; Silver Bromid.
- Carbonic acid, H₂CO₃; Form Carbonats CaCO₃; Calcium Carbonat.
- Hydrosulfuric acid, H₂S; Sulphids, ZnS; Zinc Sulphid.

- Hydroiodic acid, HI; Form Iodids, KI; Potassium Iodid
- Nitrous acid, HNO₂; Nitrats, NaNO₂; Sodium Nitrit.
- Phosphoric acid, H₃PO₄; Form Phosphats, FePO₄; Iron Phosphat.
- Hydrofluoric acid, HF; Form Fluorids, CaF₂; Calcium Fluorid.
- Chloric acid, HClO₃; Form Chlorats, KClO₃; Potassium Chlorat.

The nomenclature of acids is well illustrated by the series of chlorine acids:

Name.	Formula.
Hydrochloric.....	HCl
Hypochlorous.....	HClO
Chlorous.....	HClO ₂
Chloric.....	HClO ₃
Perchloric.....	HClO ₄

Not all elements form a complete series of acids, but the nomenclature usually agrees with the above principles.

An examination of the formulas of acids show that all do not contain the same number of hydrogen atoms. Acids are sometimes classified by the number of hydrogen atoms which can be replaced by a metal. The varying power of replaceability is called *Basicity*. A *Monobasic Acid* contains only one atom of replaceable hydrogen in a molecule, as Nitric Acid HNO₃. A molecule of Acetic acid (C₂H₃O₂) contains four atoms of hydrogen, but for reasons which are too complex to state here, only one of these atoms can be replaced by a metal. *Dibasic* and *Tribasic Acids* contain two and three replaceable atoms, as, Sulfuric acid (H₂SO₄) and Phosphoric acid (H₃PO₄). Obviously, monobasic acids form only one class of salts, dibasic acids form two classes, tribasic acids form three, etc.

EXPERIMENT NO. 51

Fill a test tube one-third full of either Hydrochloric Acid (diluted), or Sulfuric Acid (diluted). Fill another test tube one-third full of concentrated acetic acid. In some manner label the tubes for identification of the contents.

Try the action of a drop of the acid on both red and blue litmus paper.

Drop a small piece of zinc or other metal into each tube successively. If no chemical action results, warm gently. Test for the most obvious product (hydrogen) by holding a lighted match at the mouth of each tube. If no decisive action results, provide the test tube with a stopper and simple delivery tube, and collect any product in a test tube over water. This lat-

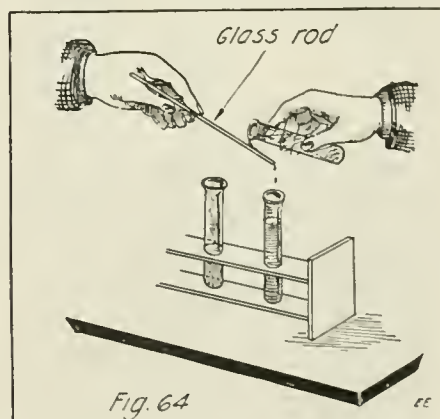

Fig. 64

Simple Method of Dropping Liquids by Means of a Glass Rod Held in the Hand.

ter method will probably be unnecessary except with the acetic acid.

(Continued on page 52)

Wrinkles Recipes Formulas

EDITED BY S. GERNSBACK

Under this heading we publish every month useful information in Mechanics, Electricity and Chemistry. We shall be pleased, of course, to have our readers send us any recipes, formulas, wrinkles, new ideas, etc., useful to the experimenter, which will be duly paid for, upon publication, if acceptable.

EXPERIMENTER'S APHORISMS

In the following, we wish to give to the Experimenter some hints as to the use of the different ingredients and how to work them:

(1) Always bear in mind that exact working of a formula requires ACCURACY, CLEANLINESS, PATIENCE, and SKILL.

(2) Know what you are about, before you start to experiment.

(3) "THE HISTORY OF FAILURES IS THE HISTORY OF SUCCESS" goes an old adage, and it applies well to the experimenter.

(4) Many times impure, wrong or deteriorated raw materials, spell FAILURE instead of SUCCESS.

(5) A great many of the chemicals and ingredients required, cannot be obtained from drug stores; buy them at a reputable supply house.

(6) BEFORE CONDEMNING A FORMULA, be sure the fault does not lie with the manner of handling it, or the purity of the ingredients.

(7) Be sure to mix the materials comprising a certain formula in the proper sequence.

(8) When starting to prepare a mixture, especially one containing liquids, ask yourself: "IS THE SPECIFIC GRAVITY CORRECT, AS INDICATED BY A HYDROMETER? IS THE TEMPERATURE RIGHT? IS THE QUANTITY OR WEIGHT RIGHT?"

(9) Acids and water, when mixed, should be manipulated in the proper manner, i. e., THE ACID SHOULD BE Poured INTO THE WATER, and not vice versa, as the solution is liable to be forcibly ejected from the containing vessel and into the mixer's face.

(10) For any kind of SYSTEMATIC WORK, a floating THERMOMETER and HYDROMETER, as well as measuring glasses and scales, should always be provided, as GUESSWORK is EXPENSIVE, and SOMETIMES FATAL.

(11) Put labels on ALL bottles, boxes and packages with FULL INSCRIPTION as to their contents, it will avoid troubles and mistakes.

(12) Remember that a beginner cannot expect to make articles AT FIRST, which will compare with regular manufactured products. S.G.

CHEMICAL EXPERIMENTS.

I have been experimenting a little and have found that an infusion of logwood chips and water will change color when other chemicals are added.

Take three glasses Nos. 1, 2 and 3 and prepare them as follows: Rinse No. 1 with strong vinegar; Dust No. 2 with powdered alum; Rinse No. 3 with a solution of copper sulfate. The next step is to pour the logwood into each. If the glasses have been prepared correctly the logwood in No. 1 will fade to a pale yellow. That in No. 2 will become almost black and that in No. 3 will change to a pale purple. This is the principal set of changes but following is a list of changes using not only logwood but also other chemicals. Some of them can be used as stated above but in the case of ammonia for instance, the odor would give it away. Color changes that are due to chemical action:

1.—Logwood, ammonia and copper sulfate gives a brown.

2.—Logwood, vinegar and ammonia gives purple.

3.—Logwood, alum and ammonia cause a red precipitate.

4.—Logwood, vinegar and copper sulfate gives a brown.

5.—Logwood, ammonia and common salt gives a light brown.

6.—Logwood, copper sulfate, common salt, and alum mixed give a pink.

7.—Phenolphthalein and ammonia gives a bright red (test for free ammonia).

8.—Copper sulfate and ammonia gives a bright blue (test for copper sulfate).

9.—Logwood and hydrogen peroxid gives a pale yellow.

10.—Logwood, copper sulfate and caustic soda gives a pale blue precipitate.

These are the results as far as I have gone but I hope to continue my work and get different results.

Contributed by W. B. SPURRIER.

HANDY APPARATUS FORMED ENTIRELY OF WIRE.

As shown in the accompanying sketches a number of useful articles of constant service to the experimenter may be constructed of ordinary wire with the aid of a few common tools.

Obtain a few feet of galvanized iron wire, or if the item of expense is not important, brass wire; 3 or 4 gage numbers are required, depending upon the size of the apparatus to be constructed.

Provide a pair each of flat, round and cutting pliers, some wood sticks about the dimensions of a lead pencil, and a few

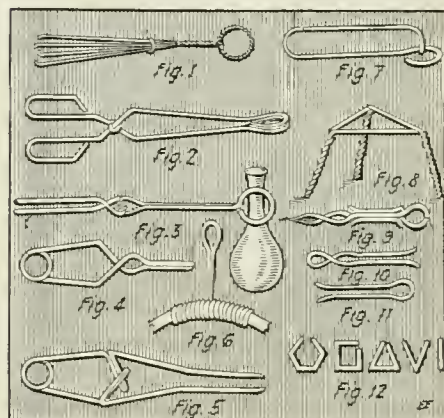

Numerous Handy Devices for Holding Test Tubes and the Like Can be Easily Constructed from Wire with a Little Ingenuity.

short lengths of tubing to aid in bending and forming the wire; after a few experiments you will be able to determine the size of the wire best adapted.

Cork Puller.

Figure 1.—Cut two pieces of wire the desired length, twist together and form ring. Now twist the four ends to about one-third the length of the shank. Make separately a ring of sufficient size to fit loosely over the shank, cut wires of shank to same length and bend ends to a right angle about $\frac{1}{8}$ inch. Slip on the ring and spring the four ends apart to keep ring in position. The completed article will be found of service in removing corks which have fallen into the container, and by placing a piece of cotton in the jaws a most useful instrument is formed for the cleaning and drying of test tubes.

Holder.

Figures 2 and 3.—Follow outline of sketch to obtain good results. Twist wires together 3 or 4 times, allowing but very little play. Bend the four ends at a straight angle and form the ring at the end of tool by bending wire around a rod of the required size.

CHEMICAL SUBSTANCES — THEIR TECHNICAL AND COMMON NAMES.

Nearly all of the chemicals in common use to-day have more than one name, and the purpose of this list is to classify some of the most common ones in use for the benefit of the amateurs who sometimes become confused in the different names. The

Aqua Fortis.....	Nitric Acid.
Aqua Regia.....	Nitro-Muriatic Acid or Nitro-Hydrochloric Acid.
Blue Vitriol.....	Sulfate of Copper.
Cream of Tartar.....	Tartrate of Potassium.
Calomel.....	Sub-Chloride of Mercury.
Chalk.....	Calcium Carbonate.
Salt of Tartar.....	Carbonate of Potassium.
Caustic Potassa.....	Hydrate Potassium.
Chloroform.....	Chlorid of Formyle.
Common Salt.....	Chlorid of Sodium.
Copperas, or Green Vitriol.....	Sulfate of Iron.
Corrosive Sublimate.....	Bi-Chlorid of Mercury.
Dry Alum.....	Sulfate Aluminum and Potassium.
Epsom Salts.....	Sulfate of Magnesium.
Ethiops Mineral.....	Black Sulfid of Mercury.
Gatena.....	Sulfid of Lead.
Glauber's Salts.....	Sulfate of Sodium.
Iron Pyrites.....	Bi-Sulfid of Iron.
Jewelers Putty.....	Oxid of Tin.
Kings Yellow.....	The Sulfid of Arsenic.
Laughing Gas.....	Protoxid of Nitrogen.
Lime.....	Oxid of Calcium.
Lunar Caustic.....	Nitrate of Silver.
Muriate of Lime.....	Chlorid of Calcium.
Niter of Saltpeter.....	Nitrate of Potash or Potassium Nitrate.
Oil of Vitriol.....	Sulfuric Acid.
Resin.....	Bi-Sulfid of Arsenic.
Red Lead.....	Lead Oxid.
Rust of Iron.....	Iron Oxid.
Sal-Ammoniac.....	Muriate of Ammonia.
Slacked Lime.....	Hydrate Calcium.
Soda.....	Oxid of Sodium.
Spirits of Hartshorn.....	Sesquicarbonate of Ammonium.
Spirits of Salt.....	Hydrochloric or Muriatic Acid.
Stucco of Plaster of Paris.....	Sulfate of Lime.
Sugar of Lead.....	Acetate of Lead.
Verdigris.....	Acetate of Copper.
Vermillion.....	Sulfid of Mercury.
Vinegar.....	Acetic Acid (dilute).
Volatile Alkali.....	Ammonia.
Water.....	Sub-Oxide of Hydrogen.
White Vitriol.....	Sulfate of Zinc.

chemicals in the two lists opposite each other are the same under a different name.

Contributed by EARL BOTTEN.

Spring Holders.

Figures 4 and 5.—Use very thick and springy wire; will be found of service in holding articles to be soldered or cemented. It will be observed from sketch that device in figure No. 4 holds by itself, while the reverse is true of No. 5 design. The ends of these holders can be made pointed or flattened as preferred.

Figure 6.—Holder for rubber tubes. Obtain a piece of thin wire. First bend it in two, making a loop to allow a hook to hold it in place. Then wind wire around a rod of proper size. Slip tube thru spiral so formed. This device will not permit tube to kink or bend at an angle sufficient to kink or to fracture.

Figure 7.—Holder for articles to be soldered or heated. The slight pressure obtained by allowing the straight bend to pass a little thru the ring will be found sufficient to hold the articles in a position convenient for operation.

Figure 8.—Tripod to support retorts. This article is formed by twisting three wires together forming a stand as shown in sketch.

Figure 9, 10 and 11.—Battery connectors. Figure 10 can be fastened to table by putting a screw or nail thru ring at its end. In the event of the contact jaws becoming loose they can be adjusted by drawing the ends closer together. The line wires can be soldered to the connectors, and if desired the connection on figure 11 can be covered with insulating tape.

Figure 12.—Very light weights. Each bend increases 1 centigram or 1 decigram, varying according to the size of wire used.

Contributed by AN EXPERIMENTER.

WITH THE AMATEURS

Our Amateur Radio Station Contest is open to all readers, whether subscribers or not. The photos are judged for best arrangement and efficiency of the apparatus. To increase the interest of this department we make it a rule not to publish photos of stations unaccompanied by that of the owner. Dark photos preferred to light toned ones. We pay each month \$3.00 prize for the best photo. Make your description brief and use only one side of the sheet. Address the Editor, "With the Amateurs" Dept.

AMATEUR RADIO STATION CONTEST Monthly Prize, \$3.00. This month's prize-winner.

RADIO STATION OF FRED DIETZ, PHILADELPHIA, PA.

I present here a flashlight photo of my station. The aerial is forty feet high, one hundred feet long, composed of three wires spaced six feet apart.

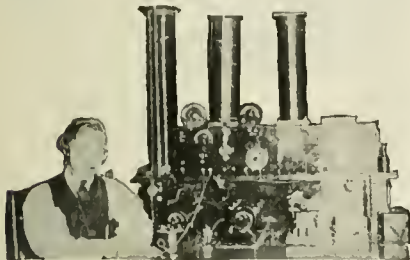

Long Wave Radio Station of This Month's Prize Winner—Mr. Fred Dietz, of Philadelphia, Pa. He Hears the German Stations and Many Others.

The sending set consists of a 1½ inch Manhattan spark coil, Murdock sending condenser, spark gap and key. I also have a six volt storage battery, and can send fifteen miles.

The receiving set consists of two loose couplers, one tunes up to two thousand meters and the other to three thousand meters. The small loose coupler is used with a crystal detector. The large loose coupler is used on the Audion and Audio-tron. I use three Bunnell variable condensers, three loading coils and a pair of Murdock 'phones. I can hear OUI, POZ, NBA (Darien, Panama), NAT (New Orleans), NAR (Key West); and a great many other land and ship stations on undamped waves. I can hear as far as Key West on a crystal detector. My call number is 3GA.

Philadelphia, Pa. FRED DIETZ.

THE FIRST "RADIO" MESSAGES.

At the battle of Ishtib a Bulgarian cow-herd signaled news to his military countrymen relative to the position of the Serbian battalions by moving five cows about in various ways on the top of a hill.

The Basutos, by the way, practically anticipated "wireless telegraphy" in a crude fashion. That is, by striking heavily on a huge drum of goat skin, which is placed on a special spot, another Basuto at a distance can gather the purport of the message by placing his ear close to the ground to catch the vibrations, and he in turn passes the message on.

Of course, given suitable climatic conditions, the military heliograph can transmit messages over enormous tracts of country, and the record is probably held by an Englishman, Captain Sadler, of the Sixth Dragoon Guards, who, by this means, succeeded in South Africa in sending a message direct a distance of 130 miles.

WALTER LITKE'S EFFICIENT RADIO STATION.

I have been reading your valuable magazine for the past two years, and have been greatly interested in the photos of amateur stations which you publish monthly. I submit two photos, one of my station and one of my aerial. My sending set consists of an E. I. Co.'s ½ k.w. transformer, a Murdock oscillation transformer, a Marconi key, straight spark gap, a photographic plate condenser consisting of ten plates, 8 by 10 inches, with tin-foil between cut 6 by 8 inches.

The receiving set consists of an Arnold Navy type loose coupler of 2,500 meters, Holtzer-Cabot 3,000 ohm 'phones, Clapp Eastham fixt condenser, Murdock variable condenser, Bunnell detector, and an aerial switch. My aerial is made of seven strand copper wire with a twenty foot mast at one end and a thirty foot one at the other. The

Antenna and Apparatus of Walter Litke's Excellent Radio Station at Fordham, N.Y. He Owns a ½ K.W. Transformer Transmitter and Knows How to Use it Effectively.



aerial is 75 feet long. I have not received my official call from the Government yet, but have my application in.

WALTER E. LITKE.

Fordham, N.Y.

ELECTRIC HAND GENERATOR DETONATES DYNAMITE.

An electric generator small enough to be carried in a man's pocket, yet powerful enough to discharge dynamite blasts, has been invented.

ATTENTION!!!

Has your station photo appeared in "The Electrical Experimenter"? Why not purchase the electrotype and have some "real" stationery printed with your station picture on it? All of the "regular radio-bugs" are doing it.

RADIO JOINS SAMOAN ISLANDS WITH UNITED STATES.

Construction of another government wireless plant, connecting the United States with its insular possessions, has been completed at Tutuila, placing the Samoan Islands in direct communication with the outside world for the first time since their acquisition by the U.S.

The station at Tutuila connects with Honolulu, where a great plant communicates with San Diego, Cal. Governor Poyer, of the Islands retired naval officer, advised Secretary Daniels on February seventeenth of the completion of the plant and transmitted a message from the native chiefs.

LEONARD NIESSEN A COMING "RADIO-BUG."

The sending set consists of a one-half inch spark coil, plate and Leyden jar condenser, oscillation transformer, spark gap and key.

The receiving set consists of a Murdock loose coupler, fixt condenser, galena and silicon detectors, Brandes' 2,000 and E. I. Co.'s 2,000 ohm 'phones and a buzzer test.

The vertical rod seen under the center of the table is an automatic closing lightning switch, operated by a foot lever, the switch itself being outside on the wall of the house. Most of the apparatus is of my own construction. The aerial consists of six wires spaced two feet apart on twelve feet spreaders, fifty feet long and forty feet high.

I am a member of the Milwaukee Radio Association, also the Central Radio Association and hold a first grade Amateur License. Call "9AKC."

Have been a subscriber to THE ELECT-

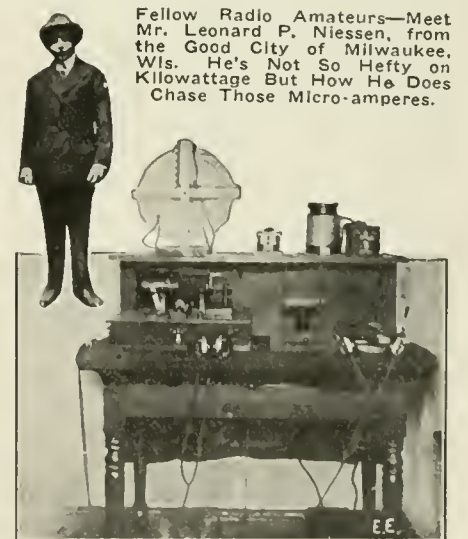

Fellow Radio Amateurs—Meet Mr. Leonard P. Niessen, from the Good City of Milwaukee, Wis. He's Not So Hefty on Kilowattage But How He Does Chase Those Micro-amperes.

TRICAL EXPERIMENTER for the last two years and have benefited greatly by reading it.

LEONARD P. NIESSEN.

Milwaukee, Wis.

PAUL RALSTON'S RADIO STATION.

With the exception of the pair of Brandes' phones, a 1/2 k.w. Packard transformer and the rotary gap motor, this set is all of my own construction.



Paul Ralston, of Conneaut Lake, Pa., is an Ardent Student of the Art of Wireless Telegraphy.

The normal sending range is 50 miles. Altho I have not a license, I receive stations as far as Key West (1,200 miles distant). My call is 1HR.

I have also increased the efficiency of my station by adding an Oscilaudion bulb, a new rotary gap and an oscillation transformer.

PAUL RALSTON.

Conneaut Lake, Pa.

550 WIRELESS MEN AVAILABLE IN PHILADELPHIA.

A trained body of 300 expert wireless operators now working on ships at sea or at commercial or naval stations along the coast, and 250 amateurs capable of com-

pleting their radio studies within a few months, is Philadelphia's contribution to the nation in the important branch of wireless communication in event of war. In addition, forty students are now enrolled in the Philadelphia School of Wireless Operating.

This school was the first to be established in America. It was started with a few pupils back in 1911, and since that time has turned out more than 300 trained men, nearly all of whom are holding commercial licenses to-day.

All licenses for wireless operating are issued by the federal authorities, so that the records at Washington constitute an index of the operating force of the country. In this respect Philadelphia is said to lead every other city with its 250 amateurs.

Altho the operation of wireless stations is kept under government regulation, no order has been issued since the breaking off of relations with Germany to make regulations more drastic, and none is expected. In some respects the large number of amateur stations means better protection for the city, for there is hardly one hour out of the twenty-four when some stations are not operating or listening.

In addition to this force, Philadelphia is guarded by three powerful stations, Wanamaker's, League Island and Cape May. Most of the commercial business of the city is handled over the plant on the roof of the Wanamaker store. This is rated at 100 miles, but its messages have been picked up as far south as Florida. The plant is generally closed now at night, but should the need arise it could be kept in constant operation and could pick up messages from a considerable distance out in the Atlantic.

GIVE COLLEGE RADIO OUTFIT.

St. Ignatius college of Cleveland, O., was presented with a new wireless outfit at an alumni smoker in the college gymnasium on February twentieth. The outfit was the gift of the alumni of the institution. Dr. Charles S. Howe, president of Case School of Applied Science, delivered an address.

HARRY WALLE'S AMATEUR RADIO STATION.

I present herewith a photograph of my wireless station, to be entered in your "Amateur Radio Station Contest." My set employs a 4 wire aerial 60 feet long. The receiving apparatus comprises a loose coupler, variometer, variable condenser, fixt condenser and a 50 tap tuning coil, which are all mounted complete in an oak-finished cabinet. The receivers are Trans-Atlantic 2,800 ohm type. The sending outfit includes a 1-inch spark coil, helix, spark



Harry Walle Finds Keen Enjoyment in His Small But Efficient Radio Station.

gap and a key. I hear 8 U E, 8 R Y and 8 G L very clearly.

HARRY VANDE WALLE.

Cincinnati, Ohio.

Amateur News

The Waco, Texas, High School Radio Club.

In September, 1914, the Waco High School Radio Club was organized with a charter membership of four.

To-day the club has an active membership of thirty, a first-class one kilowatt transmitting set, two receiving sets (one an ordinary 4,000 meter Audion set and the other a 2,500 meter regenerative set), hot wire ammeter, wave meter, motor-generator set, Multi-Audifone set, Omnigraph and various other experimental apparatus.

The Radio call is 5 YG. The club meetings are held every Friday evening. The club would welcome all communications sent to Willis F. McCracken, care of Waco High School Radio Club, Waco High School, Waco, Texas.

Ypsilanti Radio Amateur News.

The Ypsilanti Radio Amateurs have elected the following officers for the coming year:—President, Donald Knight; Secretary, Allen Rust; Treasurer, James Orr; Sergeant-at-Arms, Louis Roberts.

The club participated in a local exhibit during America's Electrical Week.

School Forms Radio Club at Arlington, Mass.

A wireless club was formed by the pupils of the Russell Grammar School of Arlington, Mass., during the month of November.

The following officers were elected:—President, Ernest A. Snow, Jr.; Vice-President, Richard Noyes; Secretary-Treasurer, Borden Billings.

The club has a set installed and meets Tuesdays and Thursdays in the afternoon to study the code.

Dansville Wireless Association of Dansville, N. Y.

On December 28, 1916, a number of "live wire" radio amateurs organized the Dansville Wireless Association.

The Club has twelve members and the station is located within the school building and would like to get in touch with other active clubs and amateurs.

The officers of the club are James Welch, President; Nohert Smith, Secretary and Conway J. Sheerin, Chief Operator.

Upper Sandusky, Ohio, Wireless Club.

The amateurs of Upper Sandusky, Ohio, have organized a club and have located in the business

section of the town. The society consists of seventeen members. We are installing a 1 K. W. transformer and expect to install an Audion set in the near future.

The following officers were elected on December 1, 1916: Ralph Casey, President; Robert Maskey, Vice-president; Russel Selligman, Secretary and Hillis Berkey, Treasurer.

Radio Amateur League.

The Radio-Amateur League of Grand Prairie and Dalworth Park, Texas, was organized March 5, and the following officers were elected: Frank M. Stubbs, President; Arthur Bradshaw, Vice-president; Ivan Ferguson, Secretary and Treasurer; Joe Ward Edwards, Chief Radio-Engineer and Press Reporter.

The "League" intends to construct most of its own instruments. We wish to communicate with other clubs and learn of their ideas. We have several ideas on the "Erection of Aerials" and the construction of other instruments which we will communicate to any clubs desiring this idea.

All communications may be addressed to the secretary at Dalworth Park, and to the President, or Radio-Engineer, at Grand Prairie, Texas.

Fifth District Radio Club Elects New Officers.

In compliance with the by-laws of the club, Mr. R. B. Godbold was re-elected President; Karl Fruebing, Secretary-Treasurer and George Deiler, Librarian, who will serve the club until July, 1917.

RADIO CLUBS ATTENTION!

We are always pleased to hear from young Edisons and Radio Clubs. Send a write-up of your Club with photos of members and apparatus to-day to: Editor "Amateur News" Section, The Electrical Experimenter, 233 Fulton St., New York City.

The headquarters of the Club are in the rooms of the Y. M. C. A. Radio School. The club owns a moderate library and has the use of a fine receiving station, also a storage battery charging plant.

Invitations are extended to all interested in the Radio Art. Meetings are held every Saturday night. Photographs of the club's set will be mailed upon request. We would also like some pictures from other clubs. Address all communications to Karl Fruebing, 1232 Magazine Street, New Orleans, La.

Eureka, Illinois, Radio Amateur News.

On the evening of March 7, the Eureka Radio Club was formed and ten members admitted. The following officers were elected: Alvin Spencer, President; Glenn Dorward, Vice-president and Henry Klaus, Secretary-Treasurer.

All communications should be addressed to the Secretary-Treasurer.

Y. M. C. A. Radio Club of Springfield, Ohio.

Under the leadership of Mr. E. Hineline, the amateurs of Springfield, Ohio, recently organized a radio club, which promises to be one of the most successful organizations of that locality. Widespread publicity was given in the local newspapers and it is reported that there are a large number of men and boys who are taking interest in wireless telegraphy. They have erected aerials and provided instruments, but so far have been working at cross-purposes with few people to talk to and no organization to further the work, so there is a need for a progressive club of amateurs.

The members of the club have planned a sending set, capable of sending two hundred miles, and a long-distance receiving set to receive all high-powered stations in this country and Europe. In organizing the club, Springfield becomes a center of activity for amateur wireless. One of the principal objects of the Club will be to teach its members the use of the Continental Code and Mr. Hineline hopes to interest the Y. M. C. A. in the new club and in this way induce a large number of boys to participate. The temporary organization which was effected at the second meeting placed the following officers—Harold Steadman, President; J. W. Fenton, Vice-president; E. J. Grieh, Secretary; Mr. Baldrige, Treasurer and J. W. Wright, Assistant Treasurer.

Address all communications to the Secretary, 121 Rose St., Springfield, Ohio.

EXPERIMENTAL PHYSICS.

(Continued from page 25)

a pointer which moves around and points to a circular scale which has been calibrated to read the same as the ordinary mercury barometer.

EXPERIMENT 23—

A thin bottle (preferably a Florence flask) is tightly corked with a rubber stopper, thru which a thin glass tube is connected. If this is inverted into a glass containing water to which a few drops of red ink have been added and the bottle is now heated, gently the air in the bottle will expand and some will pass into the water (see Fig. 19). If now the bottle is allowed to cool, some of the liquid will rise in the tube. If the colored water rises above half way up the tube some of it can be let out by raising the tube above the level of the water in the glass. This apparatus can now be used as a crude thermometer for obviously if heat is applied to the bottle, the air in the bottle will expand and push the water in the tube back towards the glass; if a colder temperature is applied the reverse will happen and the water will rise in the tube. The hotter the temperature the lower the level in the tube and the colder the temperature the higher the level in the tube. This experiment was first performed by the great Galileo and was the first method of measuring temperatures.

EXPERIMENT 24—

If a little ice is gradually added to some water in a highly polished vessel (a piece of the family silverware just answers the purpose) while the water is being stirred and a thermometer is kept in it, a temperature will be reached when the polished surface fogs, i.e., (moisture forms on it). This temperature varies according to conditions of the atmosphere and is called the *dewpoint*. This moisture does not leak thru the vessel as is commonly supposed but *condenses from the atmosphere*. We are all familiar with this phenomenon, having observed it every summer whenever ice water is served. The explanation is as follows—moisture is continually evaporating into the atmosphere and when the atmosphere contains *as much moisture as it can hold*, it is said to be *saturated*. The same amount of air can hold more and more moisture as the temperature is in-

creased and *vice versa*. Hence if the atmosphere is saturated and the temperature is decreased, some of the moisture will have to condense as the atmosphere cannot hold more moisture than *as much as it can hold*. Likewise if the atmosphere is not saturated *cooling it will saturate it* and further cooling will cause moisture to condense.

The cooling of the grass, trees, stones, etc., at night more rapidly than the atmosphere itself cools, causes the *formation of dew* (a condensation from the atmosphere). If the air near the earth also cools, the condensation also takes place on the dust particles near the earth and this condensation is called a *fog*. If this *fog* forms at some distance above the surface of the earth, it is called a *cloud*. If a considerable amount of moisture condenses in the cloud the drops become large and because of their weight fall as *rain*. Rain passing thru cold regions freezes into *hail*. If the temperature of condensation is below freezing the moisture condenses into crystals called *snowflakes*.

(To be continued)

A ONE-MAN ELECTRIC SUBMARINE.

(Continued from page 6)

on) to make several short, quick trial maneuvers, until he bumps into the hull of the enemy vessel. Also he can see a distance of 25 to 50 feet or more under water by means of the powerful electric searchlight, and once against the hull of the enemy Submarine or Dreadnought, it is but the work of a moment to excite the electromagnets in the war-head which instantly grip the steel plates of the enemy vessel with a powerful hold, and to release the war-head by means of the electro-magnetic clutches previously mentioned. The operator then scurries away at a mile-a-minute speed, and if he is but one quarter of even one-eighth of a mile away when the war-head explodes, he will be safe. In the event that the compressed air and gasoline engine driving machines should both fail on his return trip, he can send out distress rockets thru the rocket chute attached to the periscope column, and thus be rescued by a boat from the mother-ship or by patrol boats sent out from shore.

THE THERAPY OF LIGHT AND THE NEW "R-RAY."

(Continued from page 15)

radiation is somewhat similar to the Ultra-violet ray, inasmuch as an arc is used; but two different arc electrodes are employed in this work. The arc is produced between an electrode composed of quartz and mercury with a second electrode of ordinary arc carbon. Fig. 1 shows one of the complete arc lamps used in these experiments.

Viewed as a spectrogram the R-ray occupies one side of the Ultra-violet region, and grades uniformly from the first octave to out and beyond the visible portion. Also here we find radiations that cause air and matter to have such affinity that they are instantly absorbed, and investigation of their characteristics can only be conducted in a vacuum.

As resultant deductions of therapeutic interest in considering the properties of the R-ray, we find the following:

- (1) They are readily controllable and give penetrative therapeutic light of uninterrupted intensity.
- (2) They are rich in Ultra-violet rays of shorter wave lengths than the emissions from any other known arc.
- (3) They differ materially from X-rays in that they may be deflected and focussed on any given area, so as to combine their inherent heat-ray value with their visible and invisible light radiations.
- (4) They are more readily absorbed by matter than any present known arc ray, and as such secure vibratory reactions in deep-seated cellular organisms.

In order to show the position of the unmapped region wherein the R-ray lies, and as compared with the vibrations of other sources of radiation, the chart, Fig. 2 was made. It will be found very interesting to those who are pursuing the study of different sources of radiations.

The chart indicates the wave lengths of radiations ranging from the visible part of the spectrum to X-rays and the Gamma rays of radium.

To fully understand this chart, the following notation is used: the numbers across the top give their respective wave lengths in Angstrom units (one Angstrom unit is equal to 1/10 of a meter and this unit is abbreviated as A.U.). Thus the wave lengths are given in *tenths of a meter*, using here the language of the scientist. The Angstrom unit is equivalent *actually* to 10⁻¹⁰ meter, one meter being equal to 39.37 inches. The numbers below represent the number of octaves which these rays range over.

The region of about six octaves, beginning at 4 and ending at 10, represents the unmapped portion. This separates the extreme ultra-violet from the commencement of the very soft X-rays. The most easily absorbed X-rays, whose wave length has been determined, are the characteristic rays of burning aluminum with a wave length of 8.4 A.U. Passing up thru several octaves of X-rays, the limit indicated by the line "N" is reached; these represent the hardest i.e., the most penetrating X-rays, which have so far been produced. The line "M" represents the *medium* penetrating ray. It will be noticed that some of the gamma rays as produced by the disintegration of the radium atom, are of longer wave lengths than some of the shorter X-rays.

The region ranging between octaves 4 and 10 are vibrations which are easily absorbed by matter. They vary in wave length from approximately 900 to 9 A.U. The region between wave lengths 3,800 to 1,900 is the portion of radiation which is of therapeutic interest.

MAGNETIC INDICATOR FOR CRITICAL TEMPERATURES.

The fact that steel loses its magnetic properties on attaining the critical temperature forms the basis on which has been designed an instrument which infallibly indicates the instant when a mass of steel has attained the decaescent or hardening point. The instrument consists of a contact box containing magnet and coils, mounted on one end of a rod provided with handles and heat shield. The other end of the rod carries a fluxmeter, the needle of which indicates the gradual approach of the steel to the non-magnetic or critical point.

Amateur Radio Stations Licensed by the Bureau of Navigation During the Month of September, 1916 (Concluded)

FIRST DISTRICT			
Call Signal	Owner of station	Location of station	Power kilowatt
8DE	Frost, Norbert	552 Glenwood Ave., Buffalo, N. Y.	.5
8OF	Hewitt, C. Tefft	7942 Westmoreland Ave., Swissvale, Pa.	.5
8KE	Houk, Robert J.	73 Douglas St., Tiffin, Ohio.	.5
8AMX	Moyer, Edward A.	640 N. Sandusky St., Bellevue, Ohio.	.5
8BG	Peacock, Howard	Barker, N. Y.	.5
8OC	Simons, Harold C.	617 May St., Lansing, Mich.	.5
8RF	Slape, Frank	106 Eureka St., Pittsburgh, Pa.	.5
8PH	Thomas, William K.	400 Minton St., Pittsburgh, Pa.	.5
8HX	Towsley, Paul W.	1019 Berneet St., Lansing, Mich.	.5
8AMC	Warden, William F., Jr.	R. F. D. No. 11, Cuyahoga Falls, O.	1
NINTH DISTRICT			
9AJW	Baer, Elwynn W.	1710 4th St., Madison, Ill.	1
9AII	Becker, Alby	3146 32d St., Catlettsburg, Ky.	.5
9GHI	Braun, Albert L.	208 Giddings Ave., Jerseyville, Ill.	.5
9AKB	Davis, Laurence O.	Hazard, Ky.	.5
9AJT	Dubuque College	Dubuque, Iowa	1
9AJR	Fox, Harry	3116 N. 24th St., Omaha, Neb.	1
9AKF	Gitehoff, Anton A.	500 5th St., Madison, Ill.	1
9AKG	Hamlett, Robert T.	Fulton, Ky.	.5
9AKJ	Hammond, George R.	219 S. 5th Ave., Selwein, Iowa	1
9AJO	Hardy, Reginald	441 49th Ave., West Allis, Wis.	1
9AJS	Herr, Carl E.	510 9th St., Red Wing, Minn.	.5
9VD	Herron, Carson L.	1712 Court St., Le Mars, Iowa	.5
9AKA	Holmberg, Harry E.	Bottineau, N. D.	.5
9AKE	Keller, Warren H.	101 Lincolnway, La Porte, Ind.	1
9AKH	McBride, Kenneth	101 Bowen Ave., Independence, Mo.	1
9AKD	Markley, Max	416 W. Central Ave., Bluffton, Ind.	.5
9IIG	Nelson, Earl P.	1320 Commercial St., Waterloo, Ia.	.5
9AKC	Niessen, Leonard P.	430 Layton Blvd., Milwaukee, Wis.	.5
9VQ	Poser, Stanley E.	730 1st St., Milwaukee, Wis.	1
9AIU	Robinson, Roy E.	3257 Alcott St., Denver, Colo.	1
9AKK	Eyder, Earl	806 S. College St., Springfield, Ill.	.5
9AKI	Tuhtar, Eugene W.	503 6th St., Milwaukee, Wis.	.5
9AKL	Werlein, Edwin	4060 Lincoln Ave., Chicago, Ill.	1

LATEST PATENTS

Magnetic Drilling Attachment (No. 1,219,190; issued to Henry Symes.)

The inventor here provides an electro-magnetic means of feeding a machine drill against its work.

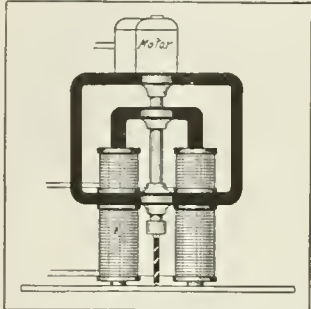

An iron frame supports the drill spindle, which is driven by an electric motor. The spindle carries a suitable iron yoke and pole-pieces which are acted upon attractively by powerful solenoid electro-magnets, tending to pull the iron pole-pieces within the coils. The current supplied the magnet coils can be varied to give various degrees of pull on the drill frame. For long vertical action two or more sets of solenoids, one above the other, can be utilized as shown.

Electric Phonograph Recorder and Reproducer

(No. 1,218,799; issued to Herman G. Pape.)
A device for making phonograph

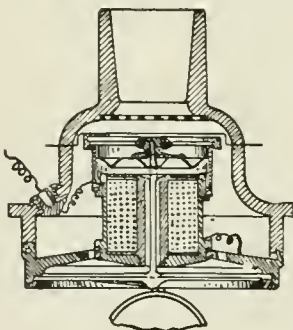

records and combining in its make-up a suitable electro-magnet, a diafram, and a means for causing the diafram to vibrate in response to electrical impulses in the electro-magnet—as from a microphone. Acoustic vibrations or sounds can operate the diafram as usual thru an open grid above it, a stylus being connected to the diafram to vibrate with it.

Electric Voting Machine

(No. 1,219,053; issued to Marshall F. Thompson and Arthur L. Townsend.)

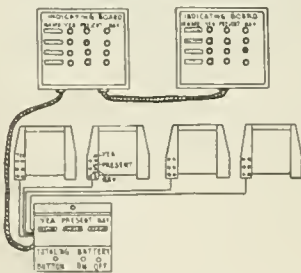

An electrically operated voting board which includes provision for totaling and recording all of the votes cast and flashing them up on

an indicator board. The primary circuit includes a voter's circuit closer, a visual lamp signal and a relay magnet. The latter closes a secondary circuit including the visual signal and a vote recording mechanism. Also there is provided a special circuit breaking attachment out of control of the voter, for the purpose of breaking the primary or voter's circuit. The idea is particularly applicable to government and society meeting chambers, making it possible to record and announce the vote of members present in the minimum of time.

Magnetic Speedometer (No. 1,219,245; issued to Allen A. Canton.)

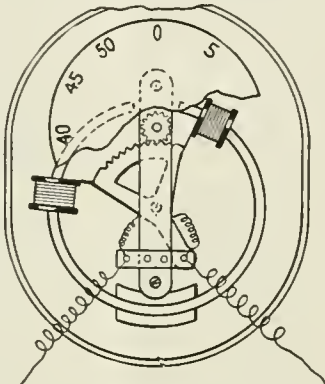

A radical departure in speedometer design, involving the use of a permanent steel magnet of ring form, over which are placed two movable magnet windings, one of which is supplied with a constant electric current and means for intermittently supplying electric current to the second solenoid coil. The magnetic reaction occurring with such an arrangement causes the coils to move. In so doing they rotate a geared sector, as shown, the sector teeth meshing with a small gear pinion fixed rigidly to the dial shaft, thus causing the numbered dial to move under an observation slot or window.

High Frequency Oscillation Apparatus (No. 1,216,646; issued to James C. Armor.)

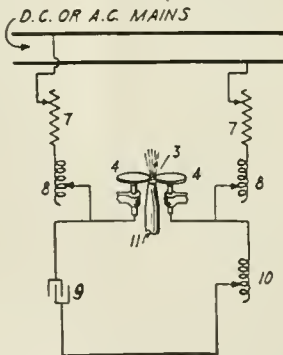

A novel scheme for producing high frequency oscillations for radio-telegraphy, radio-telephony and similar arts. Using alternating or direct current as a source, the inventor provides choke coils 8 and resistances 7, across which is shunted the special spark gap 4-4. This gap is shunted by an oscillatory circuit comprising suitable condenser 9 and inductance 10. The first discharge wave of the condenser across the gap is quenched by blowing a high velocity (5,000 ft. per second)

jet of gas or fluid between the rapidly rotating spark discs 4, 4. Higher efficiency is claimed and the production of extremely high frequency, dead-beat unidirectional discharges.

Hearing Device

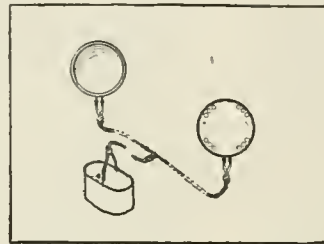

(No. 1,219,411; issued to Charles E. Williams.)

A specially sensitive electric telephone device to aid partially deaf people to hear better. Operating on the dictograph principle it comprises a super-sensitive microphone which is connected with a suitable telephone receiver and a high voltage battery. The battery comprises a plurality of cells and means for reducing the high potential by having an extra resistance wire between a terminal on one cell and a pole of another, with flexible connections between the external terminals to the receiver and microphone.

Radio Transmitting System

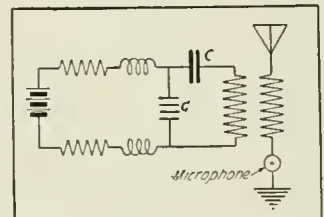

(No. 1,216,615; issued to George Seibt.)

A radio transmitter operating on direct current, which is supplied to a quenched gap, thru suitable choke impedances and resistances. A suitable coupling is provided to enable the cutting off of oscillations in the closed primary oscillating circuit after the first beat of the oscillations. The spark gap is designed to be short, and a rapid heat dissipater, thus quenching the spark and giving rise to powerful, slowly damped free oscillations in the secondary or aerial-ground oscillating circuit and, it is claimed, that the two-coupled oscillations practically disappear. This system is adapted to radio-telephony, using a microphone in the ground lead.

Submarine, Subterranean and Aerial Telephony

(No. 1,212,202; issued to Reginald A. Fessenden.)
A new phase of the Fessenden

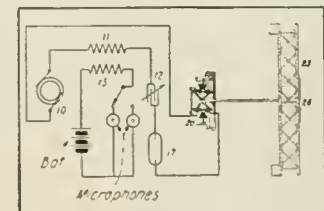

system of setting up, transmitting and receiving powerful sound waves in the form of telegraphic and telephonic signals thru water, land or air. Prof. Fessenden here invokes

the use of the Alexanderson magnetic amplifier 11-13, with which to control by microphones, the output of say a 100 K.W. radio frequency alternator. This R.F. current is past (also modulated by secondary 11) thru a rectifier 17, thence into a non-inductive oscillator 20. This is linked up with a metallic beam girder 23, supported at two points, as shown, and carrying a large metal diafram 26, say 50 feet square.

Precision Variable Inductance

(No. 1,217,348; issued to O. F. Rothen.)

The smallest part of a turn of the

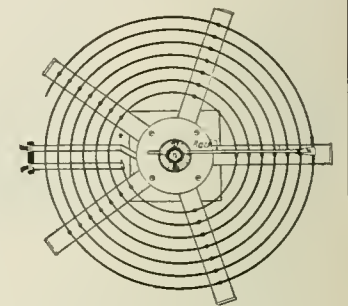

spiral may be accurately tuned in or out of the circuit by simply turning the central knob or handle. Spiral inductances of this type invariably have the defect that the slider will not follow the turns. Here the inventor provides a toothed rack on the slider arm which co-acts on a fixed central gear stud, so that as the handle is turned the slider arm is moved in or out accordingly and in a spiral path the complement of the helix. The pitch circumference of the stationary pinion is selected equal to the radial pitch of the spiral.

Electric Musical Instruments

(No. 1,216,829; issued to Harry S. Martin.)

When an interrupted current of the frequency corresponding to any certain musical note is fed into

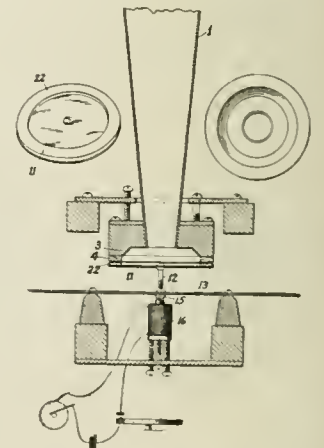

electro-magnet 16, it causes pulsating magnetic forces to act on the tuned reed 13. This in turn sets the diafram 11 vibrating at a corresponding periodicity, which vibrations are communicated to the column of air in horn 1, thru the annular mouth 3. Diafram 11 carries a felt ring 22, which may be dispensed with for certain effects. By this means it is claimed that extremely powerful and unusual sonorous vibrations are set up.

PHONEY PATENT OFFIZZ

AUTOMATTICK BRAT HUSHER
C. U. SPIDOR OF PERAMBLATOR, CA.

Species Fikation of Patent Letters

Patent Buscated

No. $\sqrt{\begin{matrix} \text{Q.R.T.} \\ \text{Q.R.M.} \\ \text{Q.S.B.} \end{matrix}}$ Q.S.C.

To Whom It Should Worry:

Let it be knowed to all fathers, fatheads, mothers, parents, and elders thruout the land and the seven seas and lakes, that I, Constantine Ulysses Spidor of the City of Perambulator, in the state of prolonged coma, have imagined, conceived, designed and executed, at the risk of my imperfect sanity, an apparatus which will revolutionize the baby industry and do away forever with "the hand that rocks the cradle."

It is a greatly to be lamented fact that our national baby industry has suffered greatly during the past decade, primarily for the reason that babies, infants, brats and other similar nuisances tend to keep their elders at home and away from tango parlors and the "movies." Not that the parents cherish the idea of staying in, no, not that. They *hafto*. For, if the nurse or hired girl take their daily spin in the family "Tin-lizzie," who would feed the brat to still his or her war-whooping?

may now tango or "movie" all night, if so desired, without in the least retarding the natural growth of their offspring. Also and most important of all, "Pah-pah" need no longer invent new forms of sudden strokes, cramps, colds, fevers, chills, etc., which make it impossible for him "just then" to leave a comfortable, warm bed, in order to perform the twice-nightly Marathon with an obstreperous brat, clutched tightly in his arms.

Having thus explained my invention in non-technical terms, I now refer to the patent drawing for further elucidation:

1, is a sensitive (but happily unfeeling) microfone. The first brat-yell jars its sensibility to such an extent that current begins to flow thru it at a terrific rate, which in turn operates electromagnet 2. This actuates pawl 3 permitting Thermos-bottle 4, containing the best imported *Extract de Cow* to con-descent downward into the brat's fists. Instinctly the Brat stuffs the

not satisfied with cow-juice and perambulating joy rides only. They wish to be talked to and sung to. Bearing this requirement in mind, when bottle 4 is empty and has ascended once more, thanks to coil-spring 13, electromagnet 12 releases victrola which begins to talk and sing lullaby to brat. This so bores the latter that he, she or it, falls to sleep at once.

If, perchance, the Brat should wake up once more and yell, 10 gets busy once more and perambuscates at once. Spring 14 has reset reproducer 15 in the meanwhile, when mother's original selection issues forth anew. This so disgusts the Brat that he, she or it, falls to sleep instanter.

What I claim is:

- 1° A self-contained automattick Brat-husher.
- 2° A Brathusher making attending parents and nurses unnecessary.
- 3° A Brathusher supplying feed, lullabys and rocking simultaneously.

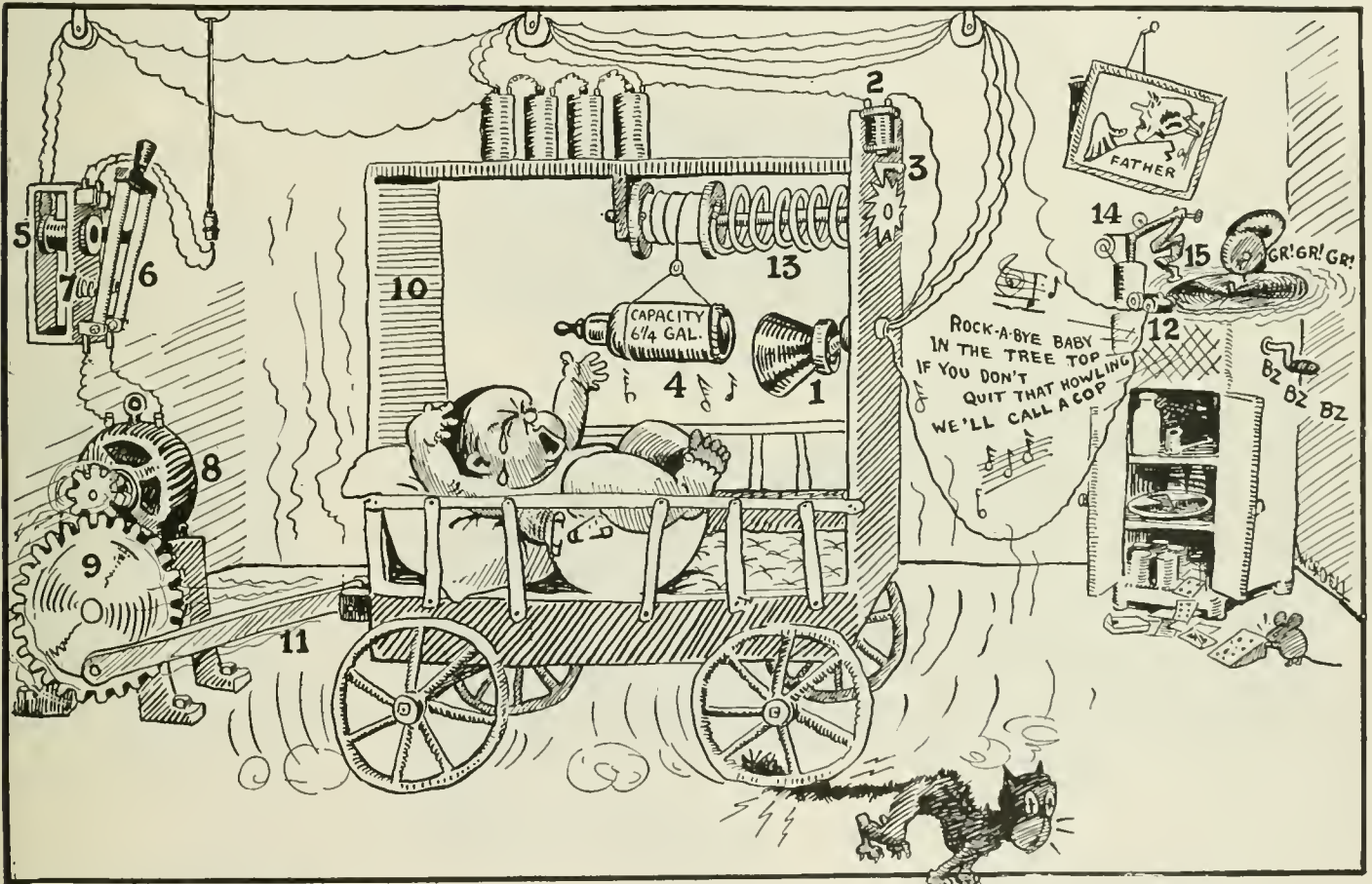

Let it Be Known to All Fathers, Fatheads, Mothers, Parents, and Elders thruout the Land and the Seven Seas and Lakes, that I Constantine Ulysses Spidor of the City of Perambulator, in the State of Prolonged Coma, Have Imagined, Conceived, Designed and Executed, at the Risk of my Imperfect Sanity, an Apparatus Known Hereinafter as an "Automattick Brat Husher" Which Will Revolutionize the Baby Industry and Do Away Forever with "the Hand That Rocks the Cradle."

The sad result of the upshot is, that the annual total production of babies and brats has almost reached the vanishing point. It is also to be noted with significant significance, that altho everything else imaginable has gone up during the war, only the output of babies and brats has gone down! And this despite of the constant uproarous roar of Teddy from Oyster Bay.

Happily, such disgraceful conditions need prevail no longer, due principally and solely to my marvelous Automattick Brat Husher. By using this inexpensive apparatus, parents

nipple in its empty void and the land becomes quiet once more. But this is not the end of a perfect day. Simultaneously with the descent of bottle 4, a contact is made and electromagnet 5 attracts switch 6, usually held off by spring 7, which now actuates instantaneously motor 8. Gear 9 takes up the Q.S.T. (General Call) and Perambulator 10 now begins to perambuscate viciously back and forward, being thus induced by arm 11.

Neither does this end the story. Brats as a rule, due to the cunning of nature are

In subscribing to the above facts, I have therefore implanted my own facsimile otograph hereunder and forever on this 27th day of Monday in the 53rd year after the advent of the safety-pin.

C. U. SPIDOR.

By his Attorney
A. Bruce Brown,
Norwich, Conn.

Witnesses:
S. H. Utup
Wade U. Givenus
Fore F. Lusher

QUESTION BOX

This department is for the sole benefit of all electrical experimenters. Questions will be answered here for the benefit of all, but only matter of sufficient interest will be published. Rules under which questions will be answered:

1. Only three questions can be submitted to be answered.
2. Only one side of sheet to be written on; matter must be typewritten or else written in ink, no penciled matter considered.
3. Sketches, diagrams, etc., must be on separate sheets. Questions address to this department cannot be answered by mail free of charge.
4. If a quick answer is desired by mail, a nominal charge of 25 cents is made for each question. If the questions entail considerable research work or intricate calculations a special rate will be charged. Correspondents will be informed as to the fee before such questions are answered.

RADIO QUERIES.

(760.) Harold Janeway, Edmonds, Wash., asks:

Q. 1. Could I hear amateur stations with a loose coupler, galena detector, fixt condenser, and an Electro "Government" 'phone in connection with an aerial fifty feet high and thirty feet long? If not what other instruments would I need?

A. 1. There is no reason why you should not receive amateur stations with the instruments you mention. A variable condenser shunted across the secondary of your loose coupler will increase the selectivity very much.

Q. 2. How can I drill holes in a marble slab so that I can mount a ground switch upon it?

A. 2. An ordinary steel twist drill should be employed which should be constantly kept wet by applying water to its boring surface.

Q. 3. Would I be violating the rules of the Fire Underwriters if I put a box over my outside ground switch and covered the ground wire with lath?

A. 3. Yes. The ground wire should be kept free from any surrounding objects.

POWER FROM PRIVATE PLANT.

(760-A.) W. C. Guibb, Grabill, Ind., wishes to know:

Q. 1. What is the best way to use the output of a private lighting system in a radio sending set? The generator has an output of 30 to 45 volts and 13.3 amperes, and charges a storage battery of 16 cells.

A. 1. The best way to utilize the electric power generated by your private plant is to employ a spark coil outfit; the size of the coil will depend upon the distance which you desire to cover.

Q. 2. Can I use it in connection with an open or closed core transformer, or is the spark coil the only way?

A. 2. Yes, providing that a mechanical vibrator is used in conjunction with it when using an open core transformer. This can either be directly operated by the transformer core or else you may employ an independent vibrator. We would advise that you employ a spark coil, say about a 4-inch coil, and you will find that it will give better service than if an open core transformer is used.

Q. 3. Could I not use the combined voltage of the generator and battery and have sufficient voltage?

A. 3. Yes; but the voltage will not be sufficient or of the correct character to operate a transformer without a mechanical interrupter.

UNDAMPED WAVE RECEPTION.

(761.) Walter B. Clifford, Worcester, Mass., writes:

Q. 1. Is it possible to employ a mineral detector in place of an Audion detector for receiving undamped signals? If so, what connection of instruments should be used?

A. 1. It is possible to receive undamped waves by employing a crystal detector providing a *tikker* of some kind is employed in the detector circuit. The diagram of

connections is given herewith and shows a circuit breaker or *tikker* being used.

Q. 2. Will you please publish a diagram of the connection of the instruments used in a simple inductive wireless telephone circuit?

A. 2. Our diagram gives the connection of a simple radio telephone employing the induction principle. The transmitting coil should be five feet in diameter while the receiving coil is four feet. Each coil is wound with one hundred turns of annunciator wire.

Q. 3. Is it advisable to employ a helix with a one inch spark coil?

A. 3. If you desire to bring your transmitting wave length to some definite value, you should employ a helix.

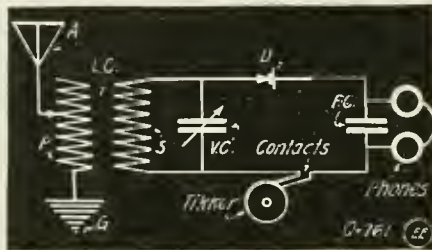

Proper Connection for "Tikker" Type of Radio Receiving Circuit for Undamped Wave Signals.

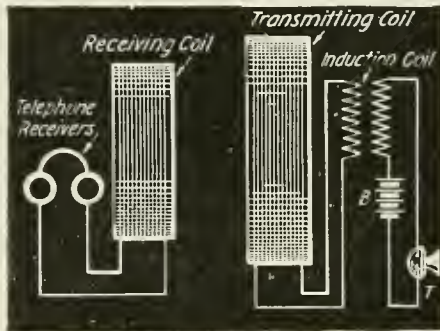

Hook-up for Inductive Wireless 'Phone.

SELENIUM.

(762.) E. W. Donaldson, Fairmont, W. Va., wishes to know:

Q. 1. In what quantities is the element selenium available?

A. 1. This element can be supplied to you in any quantities desired, and it may be procured from The Electro Importing Co., New York, N.Y., or Electro-Set Co., of Cleveland, Ohio.

Q. 2. Does it remain constant in its conductivity under periods of use, say three or four seconds several times a day or longer?

A. 2. The conductivity of selenium crystals under the influence of light is not constant but variable. The variation of conductivity of selenium depends upon many factors, such as the applied voltage, source and intensity of illumination and chemical purity of the selenium crystal.

MOTOR STARTING QUERY.

(763.) J. Adler, New York, N.Y., asks:

Q. 1. How should a shunt motor be started?

A. 1. First, the field current is applied at full line voltage; then the armature current is thrown on at much less than line voltage, the voltage being held down or controlled by resistance in a starting box; as the motor comes up to normal speed, resistance is cut out step by step until full line voltage is impressed on the armature. This is all accomplished by one rheostat of the handle of a well-designed rheostat or starting box. Most starting boxes are so arranged with a magnetic release or otherwise, that the motor is automatically cut out of the circuit in case the line voltage should, thru any accident, be shut off.

Q. 2. What is an accumulatively wound compound motor?

A. 2. It is a motor whose series and shunt field windings are in the same direction and therefore as the load comes on the series field assists the shunt field and a stronger magnetization and increased torque, with slightly reduced speed, results.

STORAGE BATTERIES.

(764.) Harry Blumenthal, Harrison, N.J., wants to know:

Q. 1. To what use is the storage battery sometimes put in electric lighting or power stations?

A. 1. To carry the *peak* of the load, i.e., that excessive portion of the load which, for instance, in electric lighting stations has to be carried only for two or three hours a day. They carry the entire load at minimum hours; to act as equalizers or reservoir.

Q. 2. How do Faure plates compare with those of the Plante type?

A. 2. They are usually lighter and have a higher capacity, but have a tendency to shed the material from the grid, thus making the battery useless.

Q. 3. At what density is the resistance of dilute sulfuric acid at a minimum?

A. 3. At 1.260 Baume.

MOTOR ACTION.

(765.) L. Askel, Detroit, Mich., asks:

Q. 1. Why does the speed of a shunt motor increase when the position of the brushes is off neutral?

A. 1. When the brushes are shifted from the neutral plane, the reverse voltage between the brushes is decreased, the speed remaining unchanged. Accordingly, the pressure in the supply mains forces an increased current thru the armature, thus producing an increased armature pull, which causes the speed to increase until the reverse voltage reaches a value sufficiently large to reduce the current to the value required to supply the necessary driving torque.

Q. 2. Can you tell me the existing mutual relations of motor torque and speed?

A. 2. The character of the work to be done not only determines the condition of the motor torque and speed required, but also the suitability of a particular type of

(Continued on page 52)

EXPERIMENTAL CHEMISTRY.

(Continued from page 43)

EXPERIMENT NO. 52

Wash the test tubes, add fresh acid, and drop a piece of Calcium carbonat (marble) into each tube successively. Proceed in the same manner as with the metals in the foregoing experiment, only in this case the gas must be tested not only with a burning match, but as follows: Dip a clean glass rod into lime-water, and hold it in the escaping gas. (The escaping gas is Carbon dioxide).

The results of these experiments are characteristic of all acids, and substances acting thus are said to be *Acid*, or to have *Acid properties*, or to have an *Acid reaction*.

The test with litmus paper is true only for litmus, but it is a striking, simple test for acids, and should be remembered, that acids turn blue litmus red.

BASES—

Bases in chemistry, includes those Hydroxids of metals which neutralize acids by partly or entirely replacing their hydrogen, thereby yielding compounds called salts.

Bases are in a few cases soluble, in most cases insoluble. When soluble in water they turn red litmus blue, and possess caustic properties.

Bases usually have an acrid or bitter taste.

Since every base contains Hydrogen and Oxygen they are sometimes called Hydroxids. Hydrat is sometimes used as a synonym of Hydroxid, while the term Alkali, emphasizes general properties rather than suggests specific composition. Hydroxids are distinguished from each other by placing the name of the metal before the word Hydroxid, as, Sodium Hydroxid, Potassium Hydroxid.

Not all bases contain the same number of hydroxyl groups. Therefore, bases, like acids, may form one or more salts. This power is called *Acidity*. Bases are called, Monacid, Diacid, Triacid bases, etc., according to the number of replaceable hydroxyl groups present in the molecule. Calcium hydroxid ($\text{Ca}[\text{OH}]_2$) is a diacid base, and Aluminum hydroxid ($\text{Al}[\text{OH}]_3$) is a triacid base.

A base contains a metallic element, as, Potassium (K), Sodium (Na), Copper (Cu), Calcium (Ca), Iron (Fe), Zinc (Zn), together with Hydrogen and Oxygen.

Below are bases:

Potassium Hydroxid	KOH
Sodium Hydroxid	Na[OH]
Calcium Hydroxid	Ca[OH] ₂
Ferric Hydroxid	Fe [OH] ₃
Copper Hydroxid	Cu [OH] ₂
Zinc Hydroxid	Zn [OH] ₂
Ammonium Hydroxid	NH ₄ OH
Aluminum Hydroxid	Al[OH] ₃

When a salt is formed from an acid and base, the metal of the base enters into the acid in place of the hydrogen, and the hydrogen combines with the Hydrogen and Oxygen of the base to form water (H_2O).

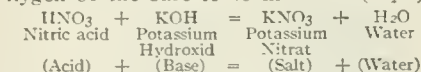

The same is true of the following:

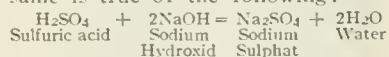

EXPERIMENT NO. 53

Pour 5 cc. of Ammonium Hydroxid (NH_4OH), 5 cc. of Sodium Hydroxid (NaOH), 5 cc. of Potassium Hydroxid (KOH), into separate test tubes and place in a test tube rack. Add about 5 cc. of water to each, and shake the contents.

Place a piece of both red and blue litmus paper (or litmus solution may be used, a drop being sufficient) into each tube and note the result.

It will be noticed upon the introduction of the litmus, that the blue paper (or solution) is unaffected, while the red paper (or solution) has turned blue. This is a characteristic of all bases, and is employed as a test for them.

After testing as above pour the contents out and rinse the tubes.

If we arrange the symbols of the above bases we have:

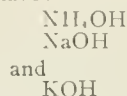

It will be noticed that the OH or hydroxyl is contained in all three. It will also be noted that the remaining portion, namely, NH_4 , Na, and K, are metallic. That the bases turn red litmus blue.

SALTS

A salt is a substance composed of a metal or positive radical united with a non-metal or negative radical. These compounds in some respects resemble common salt, that are formed by the replacement of the hydrogen of acids by metallic radicals, both simple and complex. They may be classified as Normal, Acid, and Basic salts, according to whether the hydrogen of the acid is completely or only partially replaced in the first two cases, or whether the Oxygen or hydroxyl groups of a base are only partially neutralized by an acid in the last.

A salt generally has an acrid taste.

Some salts are soluble, some insoluble.

Salts may be prepared by one of the following types.

1. Action of a metal on an acid. This, besides forming the salt, usually sets free hydrogen or some decomposition product of the acid produced by its action. For example, Zinc sulphat and copper nitrat are produced by the reactions;

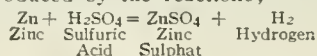

and,

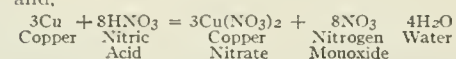

2. Neutralization of an acid by a base, the latter being an oxid, hydroxid, ammonia, or similar substance. Thus lead chlorid, sodium acetat, and ammonium nitrat are produced by the reactions:

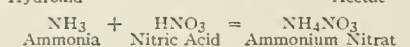
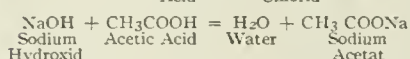
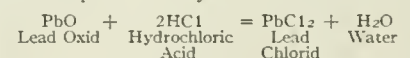

3. By the double exchange between two salts or an acid and salt, as in the preparation of Barium sulphat and Sodium hydroxide sulphat by the reactions:

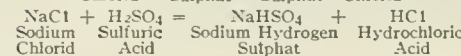
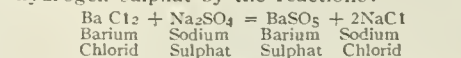

Other reactions forming salts are:—

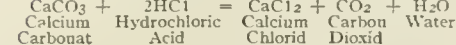
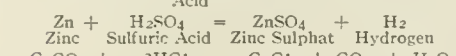
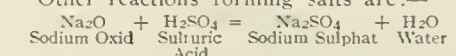

When a salt is formed from an acid and

(Continued on page 78)

QUESTION BOX.

(Continued from page 50)

motor for a given service. There are three general classes of work performed by mo-

tors and these require the following conditions of torque and speed: (a) Constant torque at variable speed; (b) variable torque at constant speed, and (c) variable torque at variable speed.

Q. 3. What is the object of the commutating field produced by the interpoles of a motor?

A. 3. Its object is to assist commutation, that is to help reverse the current in each coil while short-circuited by the brush, and thus reduce sparking.

WIRING QUERIES.

(766.) W. Holsen, Buffalo, N.Y., desires to know:

Q. 1. What are the disadvantages of open wiring?

A. 1. The wiring is not sufficiently protected from moisture and the effects of fire which will destroy the insulation of the wires; it is also liable to mechanical injury.

Q. 2. How far apart should the wires be placed if open wiring is used?

A. 2. When installed in dry places and for pressures below 300 volts, the insulators should separate the wires $2\frac{1}{2}$ inches from each other and $\frac{1}{2}$ inch from the surface over which they pass. For voltages from 300 to 500 volts the wires should be separated four inches from each other and one inch from the surface along which they pass. When wiring in damp places or over metal ceilings the wires should be at least one inch from the surface.

Q. 3. How should wires be protected when run vertically on walls?

A. 3. They should be boxed in or run in a pipe. The covering should extend six feet above the floor.

RADIO-TELEPHONY.

(767.) Marion L. Brown, Oroille, inquires:

Q. 1. Please advise me as to whether the hook-up which I send you will work on 110 volts, alternating current, using an ordinary telephone transmitter. If this hook-up will not work, please send me a simple hook-up that will work on 110 volts A.C., using telephone transmitter and one that is inexpensive to make.

A. 1. The diagram of connections which you submit will not work satisfactorily and wish to inform you that in order to make a radiophone operate on A.C. that you connect the transmitter in series with the primary of the oscillation transformer. An ordinary microphone as employed in telephone practise will handle not more than one-half ampere, so that it will be necessary for you to confine your power below $\frac{1}{2}$ K.W. If more power is to be controlled, then several microphone transmitters will be required in parallel and their mouthpieces brought to a single mouthpiece.

WAVE LENGTH PROBLEM.

(768.) Wm. H. Mansfield, Jr., Putnam, Conn., desires:

Q. 1. What is the wave length of an aerial 144 feet long, 50 feet high and a 70 foot lead-in? It is a three-wire aerial.

A. 1. The wave length of your aerial is 320 meters.

Q. 2. What is the wave length of an aerial 6 wires 30 feet high and 35 feet long?

A. 2. The wave length of this antenna is 110 meters.

Q. 3. What is the smallest sized spark coil an Oscillation Transformer can be used on efficiently?

A. 3. This will depend upon the antenna system and the wave length which you desire to tune. It may be said in general that two turns will be the least number that the coil will require. The primary winding has less turns than those of the secondary.

(Continued on page 54)



LENZITE CRYSTAL DETECTOR

Patented May 2nd, 1916

A first class Wireless Detector is half the battle in the wireless game. Have you tried the best and most effective, The "Lenzite" Crystal Detector?

Why Is Our Detector Near Perfection?

If you want to have a perfect receiving detector, try ours. If not satisfactory, return same within thirty days and we shall be pleased to refund you the price.

Being a user of an Audion Bulb and having firmly, after due test and consideration of "mineral detectors," discarded them as unstable and unreliable and very inconvenient, being hard to keep in adjustment, I was very skeptical as to Lenzite, but glad to make the test and more than pleased that I did so.

I found that the reception of signals with Lenzite as a detector quite beyond any hopes that I may have had.

Inasmuch as the mineral in question (Lenzite) seems to be "sensitive" nearly all over its surface on all sides, which is a very great advantage as it makes it almost as easy to keep in adjustment as an audion, and brings in the signals, when proper attunement is accomplished, in a very loud and positive manner, and I must add I was greatly surprised as it, without any question, has given me far greater results than any other sort of mineral detector I have tried, and I have tried to get all that I have been able to hear of.

Its clear, loud, readable demonstrations should make it very desirable to operators whether or not they use audions, which consume power which Lenzite does not, and it is quite as good for long distance work as well. I shall be glad to tell others of it.

Very truly,

HERBERT W. BRISCOE.
(6 IH U. S. License.)

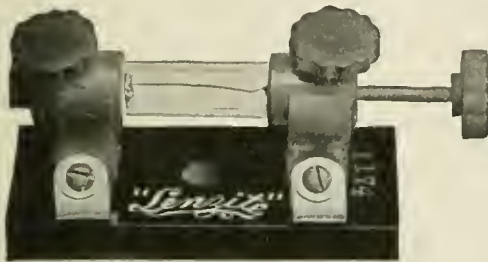

Send money order, express order or check for \$5.00 and we will send you, postage prepaid, one of our Lenzite wireless detectors.

LENZITE CRYSTAL CORPORATION
537 Chamber of Commerce Building
Pasadena, California

VACUUM TUBE DETECTORS

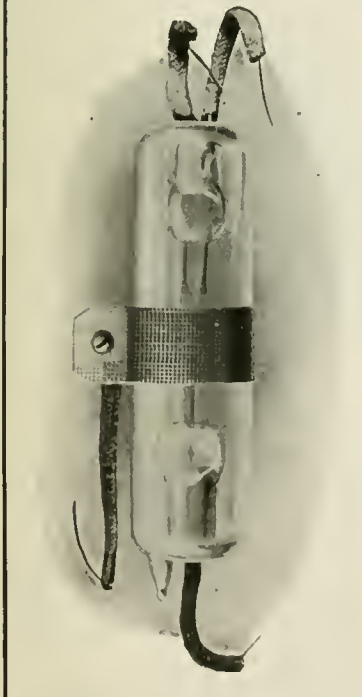

Notice to Our Customers

Have you received our new circulars containing our guarantees?

Is the tube you purchased from us giving you absolute satisfaction?

Remember we live up to our guarantees.

This detector does not employ or incorporate an evacuated vessel containing three electrodes, namely, a filament, a plate, and a grid disposed between the filament and plate.

DEALERS:--WE ARE STILL ON THE JOB

Write for Circulars

PACIFIC LABORATORIES SALES DEPT.
534 Pacific Building
San Francisco, California

THE STORY OF FLASHLIGHT MAKING.

All of us have undoubtedly found the electric flashlight extremely useful at some time or other, but very few people are privileged to know just how the flashlight is made. One of the leading manufacturers of these useful devices recently con-

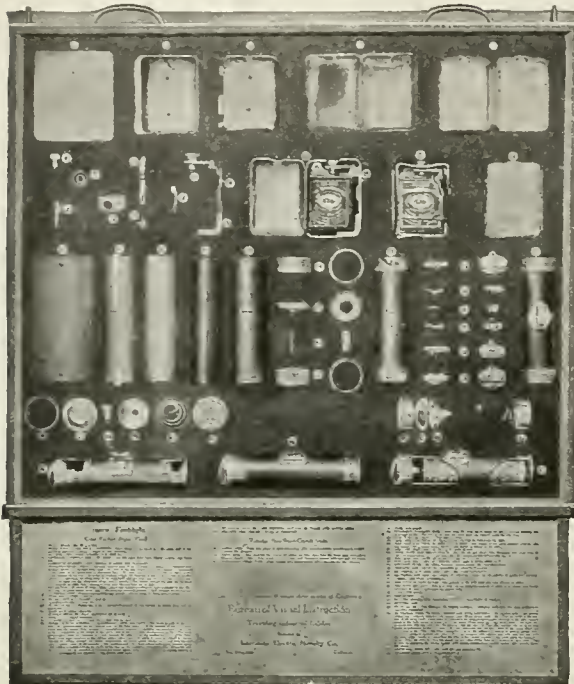

Interesting Exhibit Which Tells the Story of Flashlight Making Graphically. Every Important Stage of Manufacture Is Clearly Shown.

structed a display board containing the essential parts constituting a complete flashlight, the appearance of which may be judged from the accompanying illustration. It was used by the bureau of visual instruction of the University of California as a traveling industrial exhibit. The upper two rows represent the various stages of manufacture thru which a coat pocket style flashlight passes. The lower three rows show the progressive steps in the making of a tubular flashlight. A similar visual exhibit prepared by the same concern showed in a striking and educational manner, the various stages of flashlight battery make-up; from the zinc plate to the assembled battery, consisting of two or more cells nestling comfortably in its paper carton.

The Detroit Edison Company has made a number of tests with different methods of electrically heating cars stored in unheated garages. Various means of heating insulated and uninsulated garages have been tried and experiments made with nearly all of the heaters sold for heating the engine itself. The results of these tests are now being worked up, and they will probably be presented in a paper at one of the conventions during the summer.

ELECTRIFYING THE AEROPLANE.

(Continued from page 7)

ward the exact amount which is likewise shown in degrees. The scale is coated with Radium paint so that it is visible at night by its own light.

One of the greatest problems of aeronautical engineering is that of making the aeroplane as safe as possible. Thousands and even hundreds of thousands of dollars have been spent in this direction and the nearest conclusion to this problem is the adoption of some automatic pilot, which will

control the machine automatically in case the pilot is unable to get positive control of the machine.

The only real solution so far to this problem involves the use of the *gyroscope* and the work done by Mr. Elmer Sperry in this line gives much light to the solution. Fig. 5 illustrates the Sperry automatic pilot which relieves the pilot of the labor and drudgery in operating the controls of his machine. In the military aeroplane it renders it possible for the pilot to fulfill the duties of both pilot and observer. When dropping bombs it enables the pilot to bring the aeroplane laterally over the target, makes a reference plane of the aeroplane, which greatly increases the accuracy of bomb dropping, and creates a steady platform from which to fire and drop bombs.

The equipment consists principally of three units—the generator, servo motor and gyro unit—which may be likened respectively to the heart, muscles and brain of the human pilot.

The gyro unit which is placed in a metal case and shown in the background utilizes the gyroscopic effect of the four rotating gyros which it contains, in maintaining a horizontal reference plane. Any departure of the aeroplane for its set relation to this gyroscopic reference plane causes an electrical contact to be made which completes a circuit to one of the magnetic clutches in the servo motor. The case is equipt with a glass window to enable the operator to note the operation of the four gyros. The power generated in the servo motor air turbine is now transmitted thru the engaged clutch to one of the drums over which the control wire passes.

The generator which is seen in the foreground of the photograph supplies alternating current for driving the gyros and direct current for the servo motor clutches. It consists of a double armature, one winding of which is utilized for the generation of the alternating current and the other for direct current. It is driven by means of an aluminum propeller driven by the air current. The four leads are run from the rear to the generator.

By means of a special set of clutches on the gyro unit, the operator can set the aeroplane to any position relative to the horizontal which he may desire, by simply pressing a button located conveniently on the manual control and moving his controls as tho no automatic pilot were installed on the machine. When the aeroplane reaches the desired altitude, the button is released and control is again given over to the automatic pilot, which will hold the machine in that altitude until altered by the operator.

Complete and unhampered control may be instantly resumed at any time by pressing on the push button on the controls.

WAR CONFERENCE WITH TELEGRAPH AND TELEPHONE OFFICIALS.

Messrs. Theo. N. Vail, president of the American Telephone and Telegraph Company; Newcomb Carlton, president of the Western Union Telegraph Company; Charles P. Bruch, vice-president of the Postal Telegraph-Cable Company; F. B. McKinnon, vice-president of the United States Independent Telephone Association, and N. C. Kingsbury, vice-president of the American Telephone and Telegraph Com-

pany, were in conference with war department officials at Washington on March 19 to perfect plans to insure the government rapid and efficient wire communication.

QUESTION BOX.

(Continued from page 52)

WAVE MOTORS.

(769.) G. H. G., Detroit, Mich., inquires as to the efficiency and practicability of wave motors:

A. 1. We do not know just now of any successful installation of such wave power plants as described in the February issue of this journal and while the initial cost of installing such a plant is not so prohibitive, there has always been more or less prejudice against them, owing to the fact that the power developed is so irregular.

There have been a number of attempts made by inventors to overcome this difficulty, but the fact of the matter remains that we have yet to see a practical installation of a wave motor on any large scale. The proposition to our mind seems to possess many practical and economic features, and it seems very likely that in later years a future generation may see the adaptation of wave motors to a very large extent.

You may obtain copies of the patents issued on this interesting subject by communicating with the U. S. Patent Office, Washington, D.C., and with these before you, you will be in a better position to see just what has been done and what has been proposed in solving this problem.

CONDENSER IN AERIAL CIRCUIT.

(770.) Anthony S. Detrees, Hartford, Mich., asks:

Q. 1. Can a series condenser be used successfully in connection with a transmitter, to reduce the natural wave length of an aerial from 325 to 160 meters?

A. 1. Yes.

Q. 2. Would such an arrangement result in low efficiency in transmitting?

A. 2. The addition of a condenser in series with the antenna circuit increases considerably the amount of losses and at the same time increases the decrement due to an increase in antenna resistance by the series condenser.

32 VOLT LIGHTING PLANT.

(771.) U. J. Grant, Apple Creek, Ohio, writes:

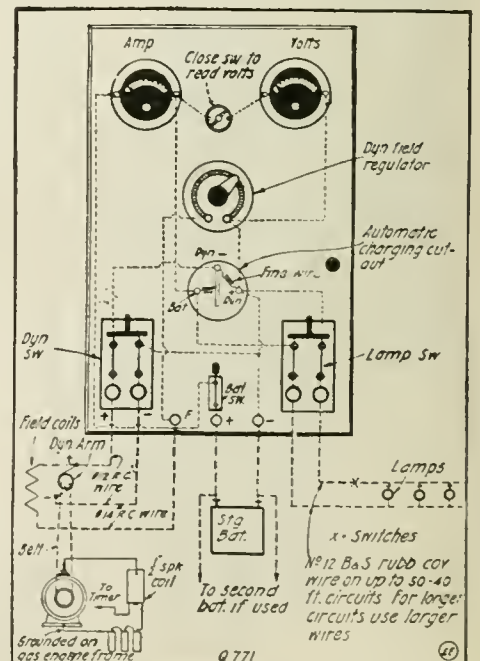

Wiring Diagram for 32 Volt Lighting Plant.

Q. 1. I would like to have a wiring diagram for a 32 volt isolated lighting plant with the following apparatus: $\frac{3}{4}$ K.W. generator, 32 volt 60 ampere-hour storage battery, switchboard with voltmeter, zero-center ammeter showing charge and discharge, circuit-breaker, regulating rheostat for generator and proper fuses and switches.

A. 1. The accompanying wiring diagram gives the connections of a complete 32 volt lighting plant.

Q. 2. What is the wave length of my inverted "L" type aerial, composed of one wire 400 feet long, 70 feet high at one end and 40 feet at the other, with 30 feet lead-in and 20 feet ground (No. 4 copper wire)?

A. 2. The wave length of your antenna is 617 meters.

DYNAMO QUERIES.

(772.) George Ledly, Cleveland, Ohio, desires to know:

Q. 1. Can a 12 volt, 9 ampere dynamo, such as the "Electro" Hercules charge successfully two 6 volt, 100 ampere-hour storage batteries in series?

A. 1. Yes. They should be connected in parallel, however.

Q. 2. Can a 25 volt, 4 ampere dynamo be run in series with four 6 volt 100 ampere storage batteries to produce 50 volts?

A. 2. Yes, providing that the batteries are fully charged. It would be advisable to employ an underload circuit breaker in the storage battery side so that they will be disconnected when they are in a discharged condition, thus preventing the charging of the battery by the dynamo in an opposite direction, in this way preventing the plates from being ruined.

The Trade-Mark of Efficiency

in wireless transformers is the word "Thordarson" on the maker's name-plate. There must be a mighty good reason why so many expert operators are satisfied only with a

THORDARSON

WIRELESS TRANSFORMER

Perfected by C. H. Thordarson whose high tension transformers have won the Gold Medal at the St. Louis and Panama-Pacific Expositions. Sold completely assembled. Five sizes, $\frac{1}{2}$ to $2\frac{1}{2}$ K.W., 10,000-20,000 volts, any cycle desired.

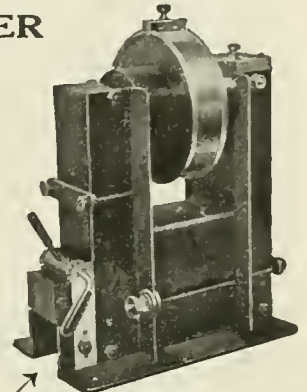

The Variable Shunt (marked by arrow) is an exclusive Thordarson feature enabling the operator to obtain perfect resonance by regulating the air-gap. Locked in position by eccentric cam.

Write for Special Bulletin and Prices

Thordarson Electric Mfg. Co.,

506 SO. JEFFERSON STREET CHICAGO, ILL.

CRYSTALOI

A Permanent Wireless Detector

OF GREAT SENSITIVITY

50 Per Cent Less Static

Ideal Construction

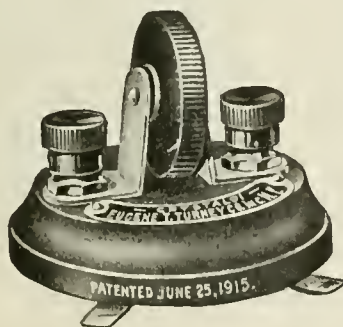

Type O. Price, \$3.50. Postage, 10c.

Rotary Adjustment

More Efficiency

The Crystaloi Detector has enjoyed a popularity far greater than any other Detector known. It has an established record of 5000 Miles and is indorsed by over 10,000 satisfied users. It reduces static at least 50 per cent which makes it especially attractive for this time of year.

Write us to-day for full information—No charge.

Send Five Cents in Stamps for Our Catalog—Everything We Make Is In It!

Eugene T. Turney Company, Inc., 2595 Third Avenue NEW YORK CITY

The New Turney Head Set

With Adjustable Pressure Head Band

Patent Applied for

Positive Friction Adjustment

3000 OHMS

Bakelite Ear Caps

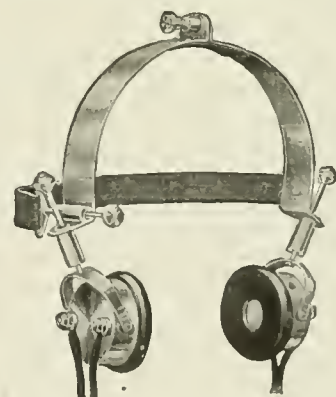

Weight Nine Ounces

Lenient Back-Check

Immediate Deliveries

Price \$7.50. Mailing Weight One Pound

Made to U. S. Navy Specifications

The popularity of this set has far exceeded our expectations. To see it is to buy it. There is not a head set on the market that can compare with it for Sensitivity—Workmanship—Finish and Design. We have sold over 600 sets in two months. There is surely a reason for this remarkable demand. Order a set today for 10 Days Trial. You can not fail to be delighted. Full information on request.

Send 10c for Our Manual of Wireless Telegraphy W9

You Get Your Money Back
on an Order of \$1.00

It contains 180 pages and tells how to erect and maintain wireless telegraph stations. Shows a number of diagrams. Has the Morse and Continental Telegraph Codes. Illustrates the best instruments to use; tells what they are for and how to use them. Has many new diagrams and other valuable information not contained in any other book. Do not wait. Send your request now. Get the best 10c value you will ever buy.



Send for Our New Catalog W28

It is pocket size, contains 248 pages, with over 1,000 illustrations and describes in plain, clear language all about Bells, Push Buttons, Batteries, Telephone and Telegraph Material, Electric Toys, Burglar and Fire Alarm Contrivances, Electric Call Bells, Electric Alarm Clocks, Medical Batteries, Motor Boat Horns, Electrically Heated Apparatus, Battery Connectors, Switches, Battery Gauges, Wireless Telegraph Instruments, Ignition Supplies, etc.

IT MEANS MONEY SAVED TO YOU
to have our Manual and our Catalog when you want to buy.

Manhattan Electrical Supply Co., Inc.

New York: Chicago: St. Louis:
17 Park Place 114 S. 5th Ave. 1106 Pine St.
San Francisco Office: 604 Mission St.

RADIO INVENTIONS

Developed from your idea or built from your rough sketches. Let us be your "partner". Your idea will be secure with us.

RADIO ENGINEERING and MANUFACTURING. We make parts and complete equipments advertised by some of the other radio companies. Structural details simplified and made practical. Let us be your manufacturer. Send sketch by registered mail for free opinion or quotations for manufacture. Enclose stamped envelope. Technical inventions bought and sold.

THE RICHARDSON COMPANY
Established 1914 Erie, Penna.

Generators!

We have a complete line of sturdy, efficient generators and alternators from 100 to 1000 watts. We furnish complete parts for these finished ready to assemble with instructions to wind. Transformers made to order. Send for catalogue.

ALL AT FACTORY PRICES

Bergmann Motor Works, 442-446 Niagara St., Buffalo, N.Y.

Alternators!

INDIRECT LIGHTING.

(773.) J. Andrews, San Francisco, Cal., inquires:

Q. 1. What is meant by indirect lighting and what are its characteristics?

A. 1. Indirect lighting as the name signifies is illumination in which the light comes to the working plane indirectly. The light of the lamp is directed at the ceiling by suitable reflector appliances, and from there is diffusely reflected into the room, making the ceiling a secondary light source.

The enlarged low brilliancy source of light, the ceiling, produces a highly uniform and diffuse illumination, free from glare. Shadows are softened and merge very gradually into the brighter areas. There is practically no glare or reflection from glossy surfaces. Recent tests apparently confirm the general belief that indirect lighting requires minimum intensity of illumination for comfortable vision and causes very low fatigue of the eye as a result of several hours' work.

Q. 2. What are the chief considerations in planning an adequate lighting installation?

A. 2. Planning a lighting installation is a complex problem, requiring due consideration of a number of factors. The intensity of illumination must be ample for clear comfortable vision; the distribution must be nearly uniform over the working plane. The color of the light must be suitable for the class of service, and the taste of the individual and the diffusion must be satisfactory for the class of service. The sources of light must be placed well above the range of vision and the intrinsic brilliancy reduced by the use of diffusing glassware or indirect reflector equipment; shadows on the working plane must be softened and toned down so as not to be too abrupt and for drafting rooms, operating rooms, etc., practically eliminated; objects capable of high specular reflection (glossy objects) should be removed from the range of vision.

POWER HOUSE PROPOSITION.

(774.) Paul Wheadon, New Brunswick, Ga., wants:

Q. 1. What types of power houses are used by large factories as we desire to equip our plant with an electric equipment?

A. 1. There are several types in common use. Some factories use 125 volts direct current. However, 220 volts direct current is popular among steel mills. The larger ones sometimes use 500 volts. Alternating current is largely used, induction motors being employed to drive machines or line shafting. Cranes are mostly operated by direct current, altho alternating current may be used for this purpose.

Q. 2. What arrangement of excitation is customary?

A. 2. Direct current generators are usually self-excited. Alternators usually require separate excitation which is had from a relatively small direct current generator. It is preferable that the exciters should have a separate prime mover if space economy is possible, tho many exciters are driven by the same engine that drives the main generator.

Q. 3. What considerations determine the voltage of a transmission line?

A. 3. The voltage of a transmission line is found by a careful study of the advantages of very high voltages in permitting the transmission of a large amount of power on a small conductor; the advantages of lower voltages because of the greater ease of insulating, the distance to be covered and the nature of the country thru which the line is to be run. Due consideration is also given to the first cost of power. If it is obtained

from water power or from very cheap coal, it may be best to design for relatively high line losses. If coal is transported a long distance, it is therefore expensive, and the line must be designed for low losses. Each case requires special study by experts.

INDOOR AERIAL.

(775.) Mr. Shanc, Grand Rapids, Mich., says:

Q. 1. Kindly let me know what an indoor aerial is made up of and the distance one can hear with the same.

A. 1. An indoor aerial is nothing more than an ordinary antenna which is erected indoors. The distance which one can receive with such an antenna depends entirely upon the sensitivity of the instruments used with this type of aerial.

Q. 2. Kindly let me know where I can get full set of rules in reference to size and power receiving and sending set the Government will allow one to have and what is necessary to pass examination to allow a large set to be erected?

A. 2. We advise you to communicate with the Radio Inspector of your district who will give you all the information you desire.

Q. 3. Kindly let me know if it is always necessary to have a wire run all the way down to the earth to make a ground and if one is in a hotel on the ninth floor or higher up, how he can make a ground without having to let a wire down to the street at the same time wanting it to be safe from all danger to property or in case of lightning and if the apparatus will be just as efficient in receiving.

A. 3. It is not necessary to run a wire down to the ground if a water or gas or even a radiator pipe is located near the station. However, in erecting a lightning ground it is necessary for you to wire from the lightning switch to the outside ground, which must connect from the ninth floor as in your case. The sensitiveness of the receiving outfit will not be lowered by this ground.

RECEIVING RADIUS.

(776.) Harry Cate, Chattanooga, Tenn., inquires:

Q. 1. Can a loose-coupler, a tuning-coil and a loading-coil all be used together successfully?

A. 1. Yes; providing they are properly connected.

Q. 2. What would be the range of the following set with an aerial 45 feet long and 40 feet high if question (1) is correct; a small tuning coil (E. I. Co.'s "Electro" tuning coil), a small loose coupler (E. I. Co.'s "Electro" loose coupler); loading coil with wave-length 5,000 meters, galena detector, 2 fix condensers and 3,000 ohm head set.

A. 2. The approximate receiving range of your apparatus is 1,500 miles.

SERIES CONDENSER.

(777.) John Huether, Sharon, Pa., inquires:

Q. 1. Is it necessary to use a series condenser with a transmitting set on an aerial 75 ft. long and 55 ft. high?

A. 1. A series condenser in the transmitting circuit is not necessary if the set is tuned to its natural period of 200 meters as permitted by the Government. With the aerial you possess it will not require a condenser in series.

Q. 2. Are you allowed to have an input of over 9.1 amperes on a 1 K. W. transformer to comply with Radio Regulations, or can you have whatever input the transformer will draw? (Operated from 110 volts A. C.)

A. 2. 9.1 amperes of current at 110 volts A.C. is just permissible. However, we would advise that the transformer should be operated on 9 amperes so as to be on the safe side.

HYDROGEN GENERATION.

(778.) W. H. Allum, Quebec, Canada, asks:

Q. 1. Would it be practical to make a small apparatus to generate hydrogen gas by the decomposition of water by direct current if so, kindly send me a rough sketch of apparatus mentioned.

A. 1. The most practical and inexpensive method of generating hydrogen gas is by the decomposition of water by a direct current. In this work, it is essential not to employ too great a voltage, but a large current. There has been a large number of different types of hydrogen generators developed but the one described on page 547 in February, 1916, issue of this journal will be found most suitable for the making of a small machine. Not only will you be able to obtain hydrogen gas but at the same time and with the same current and water you will obtain oxygen gas.

Q. 2. Would hydrogen gas generated in this manner burn by itself, the flame to be used for the purpose of lead burning in connection with the repair of storage batteries and lead containers for the same? I have access to 125 volt D.C. up to 60 amperes.

A. 2. The hydrogen gas generated by this electrical method will be required to be combined with oxygen making the so-called oxy-hydrogen blow pipe. This oxygen will be obtained from the same generator. The gas produced will be required to be collected in some reservoir chamber equipt with proper safety valves.

Q. 3. Has this gas any injurious effect on metals; if so what metals are suitable for the construction of such apparatus.

A. 3. Hydrogen gas has no injurious effects upon metals, but when combined with oxygen and ignited they will be molten as it produces terrific heat, the value of which is next to that of the electric arc.

TRANSMITTING SET.

(779.) F. Gibbons, Toronto, Ont., asks:

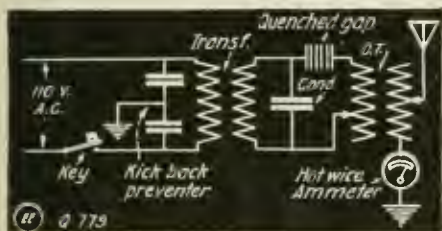

Correct Hook-Up for Quenched Spark Radio Transmitting System.

Q. 1. What instruments are required to make a transmitting set efficient? How do you connect them?

A. 1. The following instruments will be required and operated on 110 volts alternating current: $\frac{1}{2}$ K.W. 10,000 volt transformer, kick-back preventer shunted across the primary of the transformer, heavy key, high tension condenser having a capacity of .015 microfarad, 5 section quenched spark gap, oscillation transformer and hot wire ammeter used for indicating the amount of radiation in the antenna system. The connections of the instruments are given here. With the above mentioned instruments and an aerial composed of 6 wires 50 feet long and 60 feet high, you should have no trouble in covering a distance of 80 to 100 miles.



50¢ a Week

YES, for this insignificant sum you can get the great 1916 edition of the **Cyclopedia of Applied Electricity**. See it before you decide to buy. No matter what you want to know about electricity—here it is at your fingers' tips. The great authorities have written it in plain English—so that you can grasp it instantly. These books mean more money for you—promotion—the position you have been dreaming about, and all you need to do to get the entire seven volumes is to send us your name and address. Use them seven days at our expense before you decide if you want to buy.

All About Electricity!

The 1916 edition of **Cyclopedia of Applied Electricity** contains 3,200 pages, 7x10 in.; 3,000 illustrations, full-page plates, diagrams, etc.; hundreds of valuable tables and formulas; carefully cross-indexed for quick, easy reference. Printed on special quality paper and bound in half red morocco, gold stamped. Seven volumes. The standard of America—the information that is vital to you and to every man who is interested in electricity. And it is yours—on a startling offer.

Shipped FREE! Don't send us a penny. We will send the entire seven volumes prepaid right to your home, so that you can see and examine them for yourself. **Keep them seven full days.** Then decide if you can get along without them. If you think you can, send them back. If you keep them, pay \$2.00 after the seven days' trial—and then \$2.00 a month (50c a week) until \$19.80 has been paid. You are the sole judge—you do not risk a penny. This offer is open to everyone in the U. S. and Canada.

- Read These Subjects**
- Elements of Electricity—
 - Electrical Measurements—
 - Underwriters' Requirements—
 - Theory, Calculation, Design and Construction of Generators and Motors—
 - Dynamo-Electric Machinery—
 - Lighting Machinery—
 - Power Transmission—
 - Electric Railways—
 - Power Stations—
 - Switchboards and Switching—
 - Storage Batteries—
 - Applied Electro-chemistry—
 - Electric Elevators—
 - Electric Welding and Heating—
 - Wire and Wireless Telegraphy.

Consulting Service FREE!

A year's Consulting Membership (regular price \$12.00) will be given free if you send your order at once. The advice of an entire corps of electrical experts is yours—to help you in your progress—for a whole year **FREE!**

Send the Coupon

See these books for yourself before you decide to buy. Remember—don't send us a penny. Just fill out the coupon and mail it. We'll send you the entire seven volumes **prepaid**. Use them seven days—then if you want to buy pay the special reduced price at the rate of \$2.00 a month. Send the coupon now. Your ambition says—act—see for yourself.

American Technical Society
 Dept. E 7445 Chicago, U.S.A.
 Please send me **Cyclopedia of Applied Electricity** for seven days' free examination. If I keep the books will send \$2.00 within seven days and \$2.00 a month until \$19.80 has been paid, when books and Consulting Membership will be mine. Otherwise will notify you and hold books subject to your order.

AMERICAN TECHNICAL SOCIETY
 Dept. E. 7445 CHICAGO, U.S.A.

Name.....
 Address.....
 As I have had no previous dealings with you, I refer you to

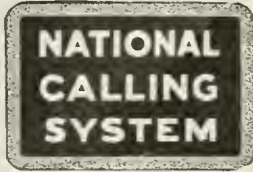

Finds Executives Instantly!

On the Dock On Shipboard

ON long, dimly lighted docks, piled high with merchandise, it is not easy to get into immediate communication with Superintendents or Foremen. On shipboard, too, Officers on tours of inspection or off duty may be wanted urgently—and no one knows where they are.

But the National Calling System will find such men at once. To illustrate: The telephone operator, having been instructed to find Mr. Smith, sets the small levers on the calling instrument for his code number and then gives the operating key a quick turn. Instantly, this code number is sounded simultaneously all over the dock or vessel, as the case may be, on electric chimes, horns, buzzers, or whatever signaling devices are in use.

Mr. Smith cannot get out of hearing of one of these signals, no matter where he goes. He gets his call instantly and immediately answers from the nearest telephone or reports in person.

No Executive or Officer on ship or dock can afford to be out of reach. The National Calling System enables him to go where he will because he can be found instantly, at any time.

Send for Complete Information and Descriptive Booklet No. 34.

NATIONAL SCALE COMPANY
(ELECTRICAL DIVISION)
6 RAPIDS STREET, CHICOPEE FALLS, MASS.

Also Manufacturers of National Counting Machines and National-Chapman Elevating Trucks



RADIO WIRING DIAGRAM.

(780.) EXPERIMENTER Reader, Pleasant Plains, Ill., desires:

Q. 1. Please give me a diagram of the following instruments for both damped and undamped wave reception: Loose coupler, loading coil, Audiotron bulb, galena detector, buzzer and push button, two variable condensers, 'phones and a large loose coupler for undamped waves. Please give necessary switches for changing from damped to undamped for either detector, and for using the variables on either the damped or undamped set. Also the necessary loading inductances in the undamped circuit if there has to be any.

A. 1. We give herewith a complete wiring diagram of a damped and undamped receiver, showing the necessary switches.

Q. 2. Could this set receive music on the undamped wave? If not, please tell me how?

A. 2. Yes, providing the Audiotron tube is set oscillating.

Q. 3. The probabilities of Congress putting a stop to, or shutting down the Amateur stations of the United States?

A. 3. The 1912 radio law provides that the President has authority to close all radio stations in case of war.

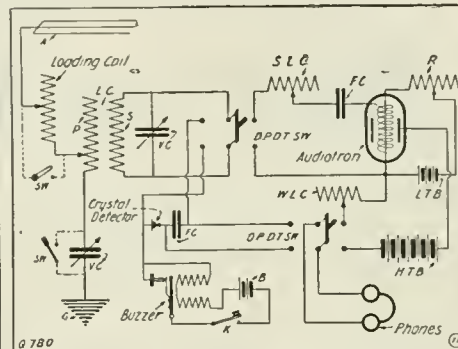

Hook-up for Audion and Crystal Detectors to Be Used in Receiving Damped and Undamped Radio Signals.

AUTOMOBILE SPARK COIL.

(781.) Leo Peterson, Thorsby, Ala., wants:

Q. 1. Would an automobile coil with three binding posts giving a spark 1/4 inch long work all right for wireless?

A. 1. It will work satisfactorily for transmitting a short distance.

AEROPLANE RADIO GROUND.

(782.) George Sloan, St. Louis, Mo., writes:

Q. 1. I would like to know the address of Dr. Nikola Tesla.

A. 1. The address of Dr. Nikola Tesla is 8 West 40th St., New York.

Q. 2. How do aeroplanes get a ground for their wires.

A. 2. By suspending a wire from the aeroplane which trails behind the machine.

RADIO ARC TRANSMITTER.

(783.) Mr. —, Pittsburgh, Pa., asks several questions regarding an article on an Arc Type Radio Transmitter by Mr. Gordon C. Farmer, which appeared in the February issue:

A. 1. It is possible to obtain a fairly high note with such an arc transmitter, especially if the arc is shunted with a suitable tone circuit after the method of Von Lepel. You might use a 43 plate Murdock variable condenser or the equivalent, providing the plates are immersed in oil. The size of the plates in the arc would remain the same for mica instead of paper; paper has been found best for this

HIGH FREQUENCY OUTFITS

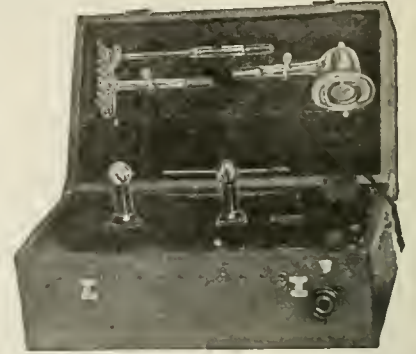

We specialize in all forms of high frequency apparatus, including apparatus for generation of Violet rays for medical treatment and sterilization of water, X-Rays, etc. The outfit illustrated is only one of three sizes we build ranging in price as follows: \$25.00; \$35.00; \$50.00. We also supply all forms of high frequency electrodes.

ROSENTHAL LABORATORIES, Camden, N. J.

SEAMLESS CARDBOARD TUBING
IN SIZES SUITABLE FOR
Tuning Coils, Loose Couplers, Testa Coils, Etc.

PRICE LIST—Smooth Wound Wireless Tubes

Outside Diam.	Lgh.	Price	Par. Post
3	x 7 1/2	.12	.18
3 1/2	x 7 1/2	.12	.18
4	x 7 1/2	.15	.22
4 1/2	x 7 1/2	.20	.27
5	x 7 1/2	.25	.31
5 1/2	x 7 1/2	.25	.33
6	x 7 1/2	.30	.37

GENERAL INFORMATION
These prices include PARCEL POST CHARGES; and are shipped at once on receipt of order and remittance. We CANNOT furnish these tubes in longer lengths than 7 1/2" unless ordered in quantities of 100 of a size. We CAN furnish SPIRAL WOUND TUBES in any length up to 45 inches at .02 per inch in the following inside diameters: 3 1/2, 4 1/2, 5, 6.

SPECIAL GRAY TUBES
18" x 6 1/2" x 6 1/2" \$1 ea. 18" x 7 1/2" x 7 1/2" \$1 ea.

BEEBLE & MACLEAN MFG. CO.
21 BROMFIELD ST. BOSTON, MASS.

FORMICA

An Insulating Material of Exceptionally High Dielectric and Mechanical Strength, Waterproof, Heat Resisting and Permanent.

Supplied in Jet Black or Brown Sheets. Also Furnished in the form of Finished Panels accurately cut to specifications.

THE FORMICA INSULATION CO.
CINCINNATI, OHIO

Electro-Set Arlington Tested WIRELESS MINERALS

When you place an Electro-set Arlington Tested Crystal in your detector you KNOW that it is sensitive. Every crystal is carefully SELECTED and TESTED before being individually PACKED and CENTS SEALED under our label. Electro-set N. A. A. minerals have proven their superior worth in actual service throughout the world. Sold by leading dealers or by mail direct. Silicon or Galena 25 cts each.

THE ELECTRO-SET CO.
Dept. E-12 Cleveland, Ohio

25

SUPER SENSITIVE
You Get Results on your Honey Back

STROMBERG - CARLSON \$8.25
RADIO HEAD SET
Stromberg-Carlson Telephone Mfg. Co.
Rochester, N. Y.

purpose after exhaustive experimentation. The paper is pierced with a pin-hole at the center when assembling the arc gap, and also it is extremely important as to just what kind of paper is employed—one of the best papers for the purpose having been found to be a certain kind of water line bond. The editor of this column does not recollect just now as to who made this paper, but you can obtain the name of the concern supplying this particular writing paper by communicating with the Institute of Radio Engineers, New York City.

An arc may be started with 500 volts using a small gap of 1/100 inch or so, especially where the circuit is made and broken by a quick break switch. The transformer described by Mr. Farmer would be rated at about one-half kilowatt.

FORMULA AND RECIPE BOOK.

(784.) Tom Otis, Cedar Rapids, Iowa, writes for information on a book containing formulas and recipes:

A. I. You will find books containing several hundred different formulas listed in our Book Catalog, which we shall be pleased to forward you on request. We shall also continue to publish a number of these formulas monthly in THE ELECTRICAL EXPERIMENTER.

ELECTRICITY AND LIFE.

(Continued from page 24)

like discharge three feet in diameter (Fig. 1), and gives a heavy arc over two feet in

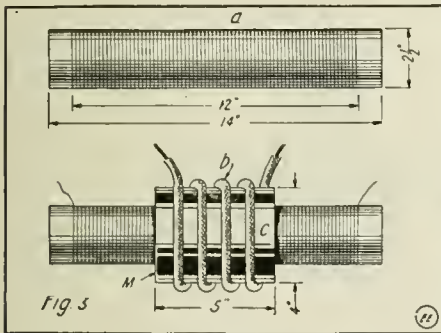

How Small Size Tesla Coil for Medical Treatment is Built; "b" is the Primary, "a" the Secondary.

length. (Fig. 2.) This shows remarkable efficiency when it is considered that the resonator is excited by a "Type E" transformer drawing only 1 K.W. and a con-

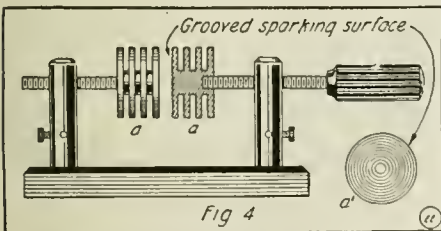

Unique Stationary Spark Gap Having Grooved Faces, as Devised by Dr. Strong.

denser of but .01 m.f. capacity. A small rotary spark gap is used such as is supplied by the E. I. Co. This result is made possible by the use of the separate inductance in series with the resonator primary (exactly the same as that described in connection with the therapeutic apparatus) (d Fig. 8). The writer believes his resonator gives the most spectacular discharge ever obtained from 1 kilowatt of energy.

Ordinary plate condensers are used, made from 8 x 10 inch negative glass, coated on both sides with tin-foil 6 x 8 inches (a Fig. 7). Six pairs of plates assembled into a

QST AMATEURS! QST

No. 20
Switch Complete

.75

Knob Only

.40

No. 20



No. 21

No. 21
Switch Complete

.45

Knob Only

.20

Build your own receiving sets and save money. Handsome knobs 1 inch high and 1 1/4 inch and 2 1/4 inches in diameter. Brass Collar 5-16 inch high. Self cleaning switch lever 1-18 inch and 1-14 inch long. These switches will make any set look 100 per cent better.

Club together and buy them in 100 lots at the following prices:

No. 20 Switch complete	- - per 100	\$52.00	No. 15 Brass contacts 1-4 in. x 1-4 tapped 6-32	- per 100	\$1.75
" 21 "	- - "	36.00	" 14 Brass contacts 5-16 in. x 5-16 tapped 6-32	- "	2.50
" 1 Knob only	- - - - "	30.00			
" 2 " " "	- - - - "	15.00			

ROTARY GAP DISCS



Made of highly polished Formica and turned absolutely true. Guaranteed not to warp or crack. "A" disc represents our famous chord note rotary. Type "A" disc furnished with either 8 or 12 points—type "B" disc in 6-8 or 12 points at no additional charge. Chuck drilled 1-4 inch shaft.

Disc complete with chuck	- - - - -	\$3.50	Chuck only	- - - - -	.60
less "	- - - - -	3.00	Ex for spec. drilled chuck up to 3-8 in.	- - - - -	.30

KLITZEN WIRELESS APPARATUS COMPANY, 1133 Herrick Ave., Racine, Wis.

NEW NEW

TWO COIL Amplifying Transformer

Especially adapted and recommended for use with all tubular vacuum detectors.

Result of six months work and great expense.

10 TO 25 TIMES AMPLIFICATION

Introductory Offer \$9.90

Delivery free anywhere in U. S. if cash accompanies order.

ONE STEP AMPLIFIER PANEL

Made of hard rubber with two 30 cell batteries without tubes.

Price \$30.00 Ready For Delivery

Our new composition rheostat absolutely essential for efficient filament control for all vacuum detectors. Write for description.

Satisfaction Guaranteed

AUDIO TRON SALES CO., 315 Lick Bldg., San Francisco, Cal.

This Efficient Tuner Only \$8.00

"Your Tuners are very selective and efficient and highly praised by the members of the Auburn Y.M.C.A. Radio Club.—Robert Eccles, Secretary and Treasurer."

Big Undamped Tuner, 20 taps on primary, 14 on secondary and brings in German stations fine, only \$15.00.

15,000 Meter Loading Inductance in quartered oak case with 9 taps, only \$8.00. Send 2-cent stamp for bulletins.

COLBY'S TELEGRAPH SCHOOL Auburn, N. Y.

DEPENDABLE KNAPP Electric Specialties

Dynamo Motor

For Boys \$6.25

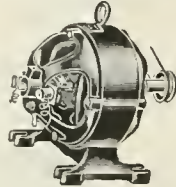

For producing current for inductance coils, re-charging storage batteries, electroplating and hundreds of other uses. Well constructed throughout, exceptionally smooth running and highly efficient. A good, strong, durable dynamo.

AT ALL LIVE DEALERS

Insist on your dealer showing you the KNAPP line—KNAPP goods are best. If your dealer cannot supply you, order direct. Send for FREE illustrated catalogue showing a complete line of Electrical Motors and Novelties ranging in price from 10c up.

KNAPP ELECTRIC & NOVELTY CO.
523 West 51st Street, N. Y. City

unit and boiled in wax give a capacity of .01 m.f. For safety it is better to employ four of these sections connected in pairs of .02 m.f. each (b Fig. 7). To run this resonator at full power for long periods of time it would be safer to use a series multiple condenser consisting of three sec-

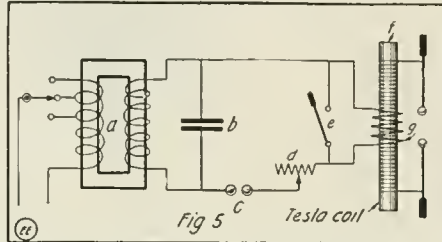

Connection Scheme for Tesla Coil "f-g," Shorting Switch "e," Tuning Inductance "d," Spark Gap "c," Condenser "b" and Step-up Exciting Transformer "a."

tions of .03 m.f. each in series. Such a condenser would contain 108—8 x 10 inch plates, and would be expensive, bulky and very heavy. For this reason the writer has found it much more convenient to use a single 12 plat (.01 m.f.) condenser across the transformer secondary and to replace it when it punctures. The large resonator was operated for six months in lecture and experimental work before a condenser section broke down.

The cone for the secondary of the large resonator is of heavy paperboard and was built for the author by Bicknell and Fuller of Boston. Its dimensions (see Fig. 6) were suggested by Mr. Earle L. Ovington, the cone being similar in shape to those used by Mr. Ovington in the New York Electrical show several years ago. Any amateur can make a cone of this kind by superimposing strips of heavy paper, soaked in paste, over a wooden framework. The secondary winding consists of 400 turns of No. 27 D.C.C. copper magnet wire. Two parallel strands of wire are wound onto the cone, the adjacent turns in contact; after winding, one strand of wire is removed, leaving a space equal to the diameter of the wire between each of the 400 turns. The cone and winding is then treated with several coats of "Armalac" (ordinary shellac will not answer).

The primary consists of five turns of thin copper ribbon 1 inch wide, 1/8 inch paperboard strips being placed between the turns. The diameter of the coil is 24". When completed it is taped and rotated in a pan of melted wax until thoroly impregnated. The terminal shown in the photograph is made from a large brass oil-can, the stem being removed and replaced by a 3" brass "bed-ball." The terminal is not attached to the cone but simply rests on its upper surface in contact with the end of the secondary wire. The primary and secondary are separately supported by

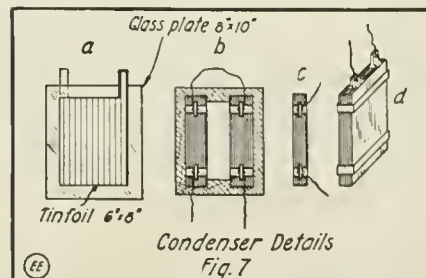

Details for Building High Tension Glass Plate Condenser to Be Connected in Tesla Coil Circuit.

quare wooden blocks; the coupling is rather loose, the bottom of the resonator being at least two inches above the primary. The lower end of the secondary coil is attached to the inner primary terminal and grounded.

Oh, You Skinny!



Why stay thin as a rail? You don't have to! And you don't have to go through life with a chest that the tailor gives you; with arms of childish strength; with legs you can hardly stand on. And what about that stomach that finishes every time you try a square meal? Are you a pill-feeder?

Do you expect Health and Strength in Tablet form—through pills, poisons and other exploited piffle?

You can't do it; it can't be done.

The only way to be well in to build up your body—all of it—through nature's methods—not by pampering the stomach. It is not FATE that is making you a failure; it's that poor, cruciated body of yours; your half-sickness sh-we plain in your face and the world loves healthy people. So be HEALTHY—STRONG—VITAL. That's LIVING. Don't think too long; Send 4c in stamps to cover mailing of my book; "Intelligence in Physical & Health Culture" written by the STRONGEST PHYSICAL CULTURE INSTRUCTOR IN THE WORLD.

LIONEL STRONGFORT
Physical Culture Expert
No. 95 Park Bldg., Newark, N. J.

Do Business by Mail

It's profitable, with accurate lists of prospects. Our catalogue contains vital information on Mail Advertising. Also prices and quantity on 6,000 national mailing lists, 99% guaranteed. Such as:

War Material Mfrs.	Wealthy Men
Cheese Box Mfrs.	Axle Grease Mfrs.
Shoe Retailers	Auto Owners
Contractors	Tin Can Mfrs.
Druggists	Farmers, Etc.

Write for this valuable reference book; also prices and samples of face-simila letters. Have us write or revise your Sales Letters.

Ross-Gould, 1009T Olive St.

Ross-Gould

Mailing Lists St. Louis

DON'T BE THIN!



Physical Perfection attracts men and women, for we all admire a well-developed person. Have you noticed that it is the cheery fellow who gets the best job? In fact he seems to get ahead in every way. I will give you a straight back, a full chest and an elastic stride, three of the best signs of vigor; besides, I guarantee to increase your weight 10 to 30 lbs., by building you up scientifically, naturally, without apparatus or drugs, in the privacy of your own room. Write today for information.

EDWARD J. RYAN, Martin Bldg., Utica, N. Y.

Be a Doctor of Chiropractic

4 Lessons FREE!

These books tell of this wonderful science of spinal adjustment. Read like fiction, yet absolutely true. 30,000,000 Americans support Chiropractic. Thousands being cured of long-standing diseases by it.

Big Opportunity for Ambitious Men and Women. Resident and Home Study Courses. Large demand for practitioners—\$2,000 to \$5,000 yearly. Small expense. Easy payments. We fit you for State Board requirements. FREE! Ebert Hubbard's Book, "The New Science." Mail postal, get all five books FREE!

National School of Chiropractic
Dept. E15 421 S. Ashland Blvd., CHICAGO

PORCELAIN

"THAT'S OUR BUSINESS"

Standard and Special Shapes, Regardless of How Difficult

We illustrate one hard shape we make. A pair of rolls 7 1/2" long and 1 1/4" in diameter with 8 holes on ends and middle. They must be perfectly straight and we make them so. It's hard but not for us. We can make your difficult designs also. Send us blue print for quotations.

Union Electrical Porcelain Works
TRENTON, N. J.

ENCLOSED ROTARY GAP



This gap has been designed to sell at a low price and to meet the demands of amateurs for a good, enclosed and silent gap. Finished in dull black, it will add to the appearance of your set.

It is made in one style only, for all powers up to 1-KW, and can be mounted in almost any position.

The gap is enclosed in a circular iron housing 8 inches in diameter and 2 1/2 inches thick, with removable cover (for inspection). The adjustment can be as close as desired between sparking points.

Rotating disc is of brass with 12 projecting round brass arms (total diameter 6 inches), mounted on shaft running in bronze bearing and is belt-driven by small motor giving a variety of tones depending upon the speed.

When in operation this gap is very quiet
Price complete, without motor, \$8.50

J. Herbert Ferris, 211 Catalpa Drive, Royal Oak, Mich.

ONE-INCH JUMP SPARK COILS for WIRE-LESS \$3.25



Guaranteed to jump as specified or money refunded.

WISCONSIN IGNITION CO.
509-513 Cedar Street, Milwaukee, Wisconsin

LOOK only \$5. No. 2 Loose Coupler.

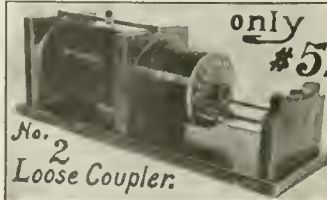

Send two cent stamp for circulars

CLIFF MFG. CO., Brookfield, Mass.

Perfect resonance is obtained by varying the number of turns in the inductance coil in series with the primary. (Fig. 8.) This tuning system enables us to perform many brilliant experiments otherwise impossible, such as illuminating wires stretched across a lecture hall, lighting an inverted umbrella, etc. Some new and very spectacular experiments with this large resonator will be described and illustrated in an article in next month's "ELECTRICAL EXPERIMENTER," entitled "Methods of employing high-frequency currents in medical and lecture work."

The author is greatly indebted to Mr. O. K. Luscolm, for advice and assistance which made possible the successful construction of the large resonator.

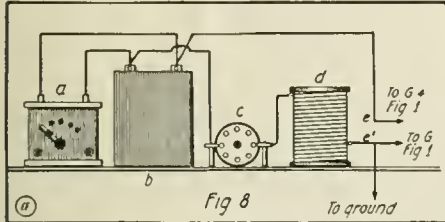

Method of Connecting Transformer, H. T. Condenser, Rotary Spark Gap and Tuning Inductance "d" to Large Oudin Coil.

At a recent lecture before the Belfast Association of Engineers Mr. A. W. Brown suggested the transmission of power generated from the tidal rise and fall of the water at Strangford Lough and Lough Neagh to Belfast. Thus, at Strangford Lough there are twenty square miles of water available, the spring tides have a rise of 14½ feet and the neap tides a rise of 11½ feet, with a range of 7½ feet. About 20,000 horsepower could be developed for a period of two and one-half

THE WASHINGTON'S BIRTHDAY RELAY PRIZE WINNERS.

(Continued from page 23)

live in a state that has as much real earth in it as is blown into the air in some of our larger states during every wind storm!

These few think they are very important and if you don't do as they say, why the Government will close you up. They say "The Danger Signal is up." Did you ever hear of a good, red-blooded American Kid who could be bluffed? No! It is not in your make-up. The Government is only too anxious for you to perfect yourself in the art, and help it out by joining the "Radio Reserves."

PRIZES.

This is a stunner for one who would like to give everybody that helped a prize, but it can't be done, so I am going to ask the boys who acted as sending stations to consider that they are one of the family and help me by agreeing that the prizes should go to the boys who made the best records in receiving and delivery. The rest of the amateurs will be rewarded by having their names printed in this magazine, so that when you grow older and have a little one on each knee in front of the old log fire, some cold night, you may read to them about Daddy and what he did when he was a mere boy.

Before you all get busy reading about the prize winners, I want to call your attention to several hard workers who turned in the most complete reports, or "logs," of the relay, that the writer has ever had the privilege of reading.

Hoyt, of Hayward, California, 6 St. who is also a prize winner, turned in the most complete report ever seen.

Stewart of St. Davids, Pennsylvania, 3 ZS, whom you all know as one of the hard hours, the power available varying from maximum to minimum every six hours.

workers of the Radio Association of Pennsylvania, turned in a truly wonderful report, but he stayed up till nearly 6 a.m. the next morning, boys, and from the looks of his "log," he went to sleep with the pen in his hand. It really only took

me about two hours to digest this report. Emerson of Dallas, Texas, 5 DU, as ex-man-o-warsman, turned in a regular Navy Report, brim full of interest and curt reports. He, too, along about the dog watch, evidently slept on duty. Bet

LOOK HERE, EXPERIMENTERS

A COMPLETE CHEMCRAFT OUTFIT FOR ONLY \$1.50
POSTAGE PAID ANYWHERE IN UNITED STATES OR CANADA



This picture shows Chemcraft No. 2, which contains 32 chemicals with complete apparatus and instructions for working 85 experiments in Chemistry and Chemical Magic. Price, postage paid, \$2.50. West of the Mississippi and to Canada, \$3.00.

Chemcraft No. 1 contains fourteen chemicals, Test Tubes, Glass Tube, Measure, etc., and a valuable instruction book telling how to work 36 wonderful experiments in Chemistry and Chemical Magic.

You can make gunpowder, colored fire and fire ink, manufacture fuses, make black and colored writing inks, prepare chlorine and hydrogen sulphide. You can prepare magic inks and papers, change water to wine and wine into water and do dozens of others. These experiments can be repeated many times and the outfit contains all the chemicals and apparatus you will need. With Chemcraft No. 1 you can also devise many new experiments of your own.

Chemicals and Apparatus for the Experimenter
We have just completed a price list of chemicals and apparatus for experimenters. Send 10c in coin or stamps for a copy of this list. It will be valuable to you.

THE PORTER CHEMICAL COMPANY
Department B. Hagerstown, Md.

Electricity
at your fingers' ends



Know the facts in Electricity. They count—and mean more money and better position for you. You need the exact information, —in a practical form so that you can use it every day, to help you install electrical equipment, or make repairs, or operate machines, or do whatever else your present job —or the job ahead of you—calls for.

HAWKINS ELECTRICAL GUIDES
help you succeed through electricity

These books will answer every one of your electrical problems. They are written so that you can understand them. Arranged in the form of questions you would ask—and the answers to them—in plain, practical, everyday language, clear, concise and to the point. Thousands of men are using Hawkins Electrical Guides as a practical aid to greater success in the electrical field.

Read What Users Say:

"Every Electrician, Operating Engineer or Student who wants to advance himself in the Electrical field should have a set of these books."
John Kelley, 116 Union St., Newark, Ohio.
"For the man not getting a college training, and even in that case, I can sincerely say I do not believe there is a better set of books on the market today."
Lloyd D. Huffman, Dayton, Ohio.

"It is the best work an apprentice can study if he wants to get ahead in his trade." As a reference for the experienced worker.
Hawkins Electrical Guides are unexcelled."
I. McClellan, Chillicothe, Mo.

SPECIALLY ARRANGED FOR HOME STUDY AND REFERENCE

They are bound in flexible covers that make them a pleasure to handle or have in your library. Size 5x6½ inches and ½ to ¾ inches thick. You can carry each separate volume about with you until you have mastered its contents. Hawkins Electrical Guides fit your pocket and your pocket book as well. Only \$1 per volume and owners of the set say there are no better electrical books at any price.

HAWKINS GUIDES
3,500 PAGES
4,700 ILLUSTRATIONS
\$1 A VOLUME
\$1 A MONTH

Shipped to You FREE

Send no money. Examine the books first. Decide for yourself that they are the most complete and clearest written electrical books ever published. Every book is complete in itself, but the entire set is the best bargain. Accept this unusual offer now—mail the coupon today. If you decide to keep the books you can make settlement at only \$1 per month, until paid for.

PARTIAL CONTENTS

- Magnets—Induction—Experiments—Dynamos—Electric Machinery—Motors—Armatures—Armature Windings—Installing of Dynamos—Electrical Instrument Testing—Practical Management of Dynamos and Motors—Distribution Systems—Wiring—Wire Diagrams—Sign Flasher—Storage Batteries—Principles of Alternating Currents and Alternators—Alternating Current Motors—Transformers—Converters—Rectifiers—Alternating Current Systems—Circuit Breakers—Measuring Instruments—Switchboards—Wiring—Power Stations—Installing—Telephone—Telegraph—Wireless—Bells—Lighting—Railways. Also many Modern Practical Applications of Electricity and Ready Reference Index of the 10 numbers.

Theo. Audel & Co.
72 Fifth Ave.
New York

Please submit me for examination Hawkins Electrical Guides (Price \$1 each). Ship at once, prepaid, the 1 number. If satisfactory I agree to send you \$1 within seven days and to further mail you \$1 each month until paid.

Signature

Occupation

Business Address

Residence

Reference

MAIL THIS FREE COUPON TODAY

You benefit by mentioning "The Electrical Experimenter" when writing to advertisers.

he is glad he wasn't aboard the good ship "Hardship," as they shoot men in war-time for sleeping on duty. He was right on deck tho, all the time, and the writer could clearly read his calls to 9 ZF and answers to the boys east.

The boys of the San Francisco Radio Club also made splendid reports, as did also our College Professors, who are always with us.

A perfectly legal report was also received from a staid old lawyer in Jacksonville, Fla., who prefaced his letter with the remark that he was not trying for a prize, but being a "Radio-Bug," he just could not keep still.

A well known D. D. S. in Elmira, also sent in a very complete report and called it a great night's work.

I just compared two interesting letters from one amateur.

1916. *He was diligently stabbing a piece of galena and complaining about his vibrator sticking on his one inch coil. Said he did not get M.S.G. but thought he would report anyway.*

1917. *He sent me a list of stations he*

hears, as long as your arm, and he is now sporting a one K.W. and working as a star relay station, 1,000 miles being as nothing to him. I heard him from my station—clear, quick sending; prompt business-like signatures, and abbreviations that went clear over my head. "The world do move!"

PRIZE WINNERS.

Mr. E. B. Duvall and Mr. A. P. Smith are awarded the prize of the Electro Importing Company—their "Nauen POZ" Radio Receiving Set! These young men operate jointly the Radio Station, 3 AK, in Baltimore, Md. This prize is awarded for the quickest delivery of both messages, and particularly in being on the job for the return M.S.G. No one but the sending stations east of 9 ZF knew when the east bound M.S.G. was coming thru. If this had been a real emergency call for Government help on 200 meters, these same fellows would have landed the message just the same. Congratulations to them.

SECOND PRIZE.

Mr. W. B. Pope, 4 AA, of Athens,

Georgia, is awarded the *Professional Wave Meter*, donated by the Electro Importing Company of New York. It was awarded for long distance reception, prompt business-like delivery, and for perfect indexing, timing and marking both east and westbound messages, received in approved commercial style. From a study of the Q.R.M. map, he was seriously handicapped on both messages, and is heartily congratulated by the writer and all good radio "sports."

THIRD PRIZE.

Kenneth Briggs of Rochester, N.Y., 8 MG, whom you all remember as almost catching up with C. E. Hughes, the presidential candidate, with a copy of the Relay Message on October 27th, 1916, is awarded the *One K.W. Thordarson Transformer*, donated again by the Thordarson Transformer Company of Chicago, thru their Mr. Connors. Mr. Briggs is congratulated on his persistency, good receiving, prompt delivery and true American spirit, as he showed not the least jealousy toward several who were working against him. The Q.R.M. map showed marked interference, particularly on westbound messages, and he can thank the Q.R.T. of W. C. Ballard, Jr., at Cornell College, 8 NU, for giving him the chance to win this prize. I hope he will perfect his sending apparatus, and line up with the Q.R.M. League.

FOURTH PRIZE.

Scott High School of Toledo, Ohio, is awarded the William B. Duck's celebrated *Arlington Tuner*; for long distance reception with moderate apparatus; diligent and persistent listening for the return message and very complete business-like report.

FIFTH PRIZE.

Leander L. Hoyt of Hayward, Cal., 6 SI, is awarded the *Chambers No. 749* tuner for the reception of arc and spark signals. This prize is awarded for the long distance work and incessant effort to line the boys up in that neighborhood to a realization that, for once, California would be put on the Relay Map. Mr. Hoyt, besides, turned in one of the most wonderful and complete reports on everything of importance that happened, from the moment the westbound M.S.G. left New York, until the eastbound message arrived in the same city. The absence of jealousy shows he is a real man—an American—and one from whom we will hear more later on. To satisfy you all, we will publish this report in this magazine, if Mr. Hoyt's permission to do so may be obtained later. We most earnestly hope Mr. Hoyt will not find as much real cause for worry when listening in on the wave lengths from 6,000 meters up as he heard during the relay from 600 meters down. California is surely lined up now for good work with such fellows as 6 EA for sending L.D. and 6 SI for detail work. Mr. Hoyt will make a valuable addition to the Q.R.M. League.

SIXTH PRIZE.

Mr. and Mrs. C. Candler—8 NH, whom you all know and have heard, are located in St. Mary's, Ohio, but their "Sigs." do not stay at home. During the Presidential Relay, this station received six hard-earned credits and later stated that their transformer was not working right. They surely proved this during the last relay, as their "Sigs." were everywhere, and if it had not been for this station, lots of stations south and west would never have received the Westbound M.S.G. at all. Some who did not know 8 NH was supposed to help on relay, reported him as Q.R.M. When you all get your stations arranged so that you can Q.R.M. boys 1,000 miles away, you are sure on the trail of efficient long distance work.

This station is awarded the prize of the

"Geyser" Electric Water Heater



INSTANTLY The Hot Bath is Ready

Continuous Flow of Water as Desired. Always Ready.

You only pay for electricity as used. All water that passes through the "Geyser" is thoroughly sterilized. The "Geyser" is perfectly insulated and is absolutely safe, no danger of short circuiting or electric shock.

Cold to Hot Water by Merely Turning Handle.

Both the water and the current act together and both controlled by the movement of the faucet handle. To secure hot water turn handle to the left, for cold water turn to the right, at the center both the water and current are shut off.

The Supreme Court has decided that we control the absolute right to the manufacturing of "Geyser" Electric Water Heater. Others take warning, as we will prosecute any infringing on same. Write us today to send you full information

FELDMAN MFG. CO., Inc.

1514 Times Building, New York

Perfection Radio Laboratory of Clinton, Iowa. *One Short Wave Amplifying Tuner.* The writer used a tuner of this make during the last relay and could hear the "Sigs." of 4 CL and 2 PM, very Q.S.A. It is a very small and compact affair and am sure 8 NH will find it a most valuable addition to their station. The owner or maker of this apparatus calls it a "Cow Sucker." It is the most sensitive and reliable receiver the writer has ever used.

SEVENTH PRIZE.

O. R. Terry, Stoughton, Wis., is awarded the prize of the Manhattan Electric Supply Company of Chicago. This is a pair of 3,000 Ohm Mesco phones. They are dandies, and the writer has been using a pair for the last year. Mr. Terry made a creditable report and great record for receiving thru Q.R.M. of the worst kind.

EIGHTH PRIZE.

The Phoenix Radio Club of Phoenix, Ariz., is awarded the donation of Mr. Philip E. Edelman of St. Paul, Minn. This is his latest book, "Experimental Wireless Stations," and it is a wonder how so much useful information has been crowded into such a compact space. This book will put Arizona on the wireless map forever, and the prize is awarded for long distance reception, cooperation in the relay, and real genuine American patriotism in keeping quiet when necessary.

INSTRUCTIONS.

The prize winners may obtain these prizes by writing to the above Donees and giving your name and address, and referring to this issue of THE ELECTRICAL EXPERIMENTER.

Q.R.M.

There is not enough space in this magazine to report all Q.R.M., but some of it was intentional, and the writer does not care to stir up any ill feeling by publishing it. If you are interested in knowing, however, who deliberately Q.R.M.'d the stations in Connecticut and Massachusetts at 10:35 p.m., the night of February 24, 1917, write to 1 IZ—R. T. St. James, Great Barrington, Mass.

PERFECT SCORES.

Below you will find the names of the boys and stations that made "perfect scores."

ARKANSAS.

John M. Clayton, 5 BV, Little Rock

ARIZONA.

R. A. of Arizona, 6 FD, Phoenix
L. E. Glenn, 6 IT, Alhambra
J. Giraud, 6 EO, Phoenix
R. Higgy, 6 DM, Phoenix

COLORADO.

E. F. Doig, 9 ZF, Denver
W. H. Smith, 9 ZF, Denver

CALIFORNIA.

Seefred Bros., 6 EA, Los Angeles
L. Lynde, 6 UG, Long Beach
C. H. Hirst, Stanford University
F. Terman, 6 FT, Stanford University
L. L. Hoyt, 6 SI Hayward

CONNECTICUT.

H. Haugh, III, Derby

DAKOTAS.

M. Tuve, MT, Canton, S.D.
P. C. Green, PG, Aberdeen, S.D.
D. Cottam, DCL, La Moure, N.D.
E. Worthington, 9 APG, Aberdeen, S.D.
E. R. Issak, 9 TZ, Eureka, S.D.
A. Shaw, AS, Parkston, S.D.

FLORIDA.

J. C. Cooper, Jr., Esq., 4 EI, Jacksonville
C. M. West, U.S.N., St. Augustine

GEORGIA.

D. L. Gaston, CVW, Commerce
A. F. Hood, CWW, Commerce

Super-Sensitive Microphone Only \$6

This instrument is offered at an extremely low price. It is excellent for building your own radio amplifier. Can also be used in many experiments where a sensitive microphone is required.



DETECTAGRAPH, \$12

This detecting instrument of marvelous sensitivity can be used for detecting secret conversations. Outfit consists of Sensitive Transmitter, 25-ft. Black Cord, Receiver, Headband, Case and Battery.

Send for One Today and Convince Yourself

MICROPHO-DETECTOR COMPANY

GASTON BOISSONNAULT, President

119 NASSAU STREET, NEW YORK

Makers of Super-Sensitive Microphone Apparatus

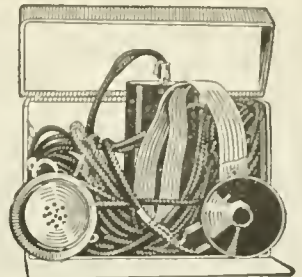

DETECTAGRAPH \$12

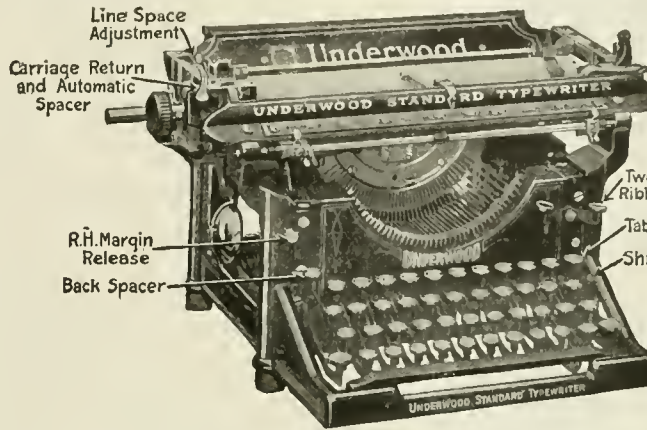

I want, through this advertisement, to establish as friendly business relations with you as I possibly can. I want you to realize also, that it is my earnest effort and intention to give you full, honest value for every dollar that you spend with me. This is the only way I can succeed. My advertisement has appeared in this magazine continuously for more than four years.

I am building up my business on the foundation of good value and square dealings. I am saving thousands of satisfied customers thousands of dollars by supplying perfect —late style—visible writing—typewriters, at remarkably low prices.

All my transactions are handled throughout by personal correspondence. I assure you every courtesy and consideration in your dealings with me. Your order will have my prompt, careful, personal attention. I will be glad to do business with you,

Harry A. Smith

ALL LATEST IMPROVEMENTS

TYPEWRITER SENSATION

Free TRIAL—Use as You Pay

Send me only \$3.00 a month until the low total price of \$49.15 is paid, and the machine is yours

This is absolutely the most generous typewriter offer ever made. Do not rent a machine when you can pay \$3.00 a month and own one. Think of it—Buying a \$100.00 machine for \$49.15. Cash price \$46.45. Never before has anything like this been attempted.

STANDARD UNDERWOOD VISIBLE

Perfect machines, Standard Size, Keyboard of Standard Universal Arrangement, writing the full 84 characters—universally used in teaching the touch system. The entire line of writing completely visible at all times, has the inbuilt tabulator, with billing devices, the two-color ribbon—with automatic reverse and key controlled shift, automatic flexible paper feed—automatic paper fingers the back spacer—roller bearing carriage action—in fact every late style feature and modern operating convenience. Comes to you with everything complete, tools, cover, operating book and instructions, ribbon, practice paper—nothing extra to buy. You cannot imagine the perfection of this beautiful reconstructed typewriter until you have seen it. I have sold several thousand perfect latest style machines at my bargain price and everyone of these thousands of satisfied customers had the beautiful, strictly up-to-date machine on 5 days' free trial before deciding to buy it. I will send it to you F. O. B. Chicago for five days' free trial. It will sell itself, but if you are not satisfied that this is the greatest typewriter you ever saw, you can return it at my expense. You won't want to return it after you try it—you cannot equal this wonderful value anywhere.

You Take No Risk—Put in Your Order Now

When the typewriter arrives deposit with the express agent \$7.15 and take the machine for five days' trial. If you are convinced that it is the best typewriter you ever saw, keep it and send me \$3.00 a month until my bargain price of \$49.15 is paid. If you don't want it, return it to the express agent, receive your \$7.15 and return the machine to me. I will pay the return express charges. This machine is guaranteed just as if you paid \$100.00 for it. It is standard. Over one hundred thousand people own and use these typewriters and think them the best ever manufactured. The supply at this price is very limited, the price will probably be raised when my next advertisement appears, so don't delay. Fill in the coupon today—mail to me—the typewriter will be shipped promptly. There is no red tape. I employ no solicitors—no collectors—no chattel mortgage. It is simply understood that I retain title to the machine until the full \$49.15 is paid. You cannot lose. It is the greatest typewriter opportunity you will ever have. Do not send me one cent. Get the coupon in the mails today—sure.

H. A. SMITH
Room 738
231 N. Fifth Ave.
CHICAGO, ILL.

Ship me the UNDERWOOD F.O.B. Chicago, as described in this advertisement. I will pay you the \$42.00 balance of the SPECIAL \$49.15 purchase price at the rate of \$3.00 per month. The title to remain in you until fully paid for. It is understood that I have five days in which to examine and try the typewriter. If I choose not to keep it, I will carefully repack it and return it to the express agent. It is understood that you give the standard guarantee for one year.

Name

Address

HARRY A. SMITH

738-231 N. Fifth Avenue Chicago

A Motor and a Rotor for \$5.25

We have built 5000 of these outfits, consisting of a motor that will operate on a. c. or d. c., 5000 to 6000 r. p. m., 100 to 130 volts.



One-half actual size

An aluminum rotor, perfectly balanced, machined and insulated.

Regular price of these outfits, \$8.50 **\$4.00**

Introductory offer as above, while they last. Act quick. **\$1.50**

When ordering rotors give size of shaft

The Fosco Corporation

1355 N. Western Ave., Chicago, Ill.

Send postage for catalogue of motors and supplies

C. H. Williams, 4 CY, Covington
J. R. Shumate, 4 EC, Tomassville
W. B. Pope, 4 AA, Athens

INDIANA.

G. Decker, 9 QNO, Ligonier
L. B. Wilcox, 9 KH, Angola
L. Gehring, 9 AAS, Bluffton
P. K. Romey, 9 QR, Columbia City
J. E. Williams, JW, La Grange

ILLINOIS.

S. W. Pierson, 9 PY, Carrolton
R. H. G. Mathews, 9 ZN, Chicago
E. E. Boynton, 9 ARA, Sycamore
L. A. Kern, 9 GY, Mattoon
H. Klaus, HK, Eureka
R. W. Beard, 9 GK, Pleasant Plains
E. H. Giddings, 9 MK, Lanark
H. A. Mackley, 9 AIM, Peoria

IOWA.

W. E. Slanson, 9 AMI, Monticello
H. O. Ainsworth, 9 AMI, Monticello
S. U. of Iowa, 9 YA, Iowa City
Don Bailey, 9 RD, Clinton
Lester Fawcett, 9 AIF, Independence
C. Tumwall, CT, Ottumwa
W. Harper, WH, Ottumwa
H. M. Ennis, HME, Ottumwa
Kent Bros., 9 ARF, De Witt
"The Old War Horse," 9 RD, Clinton

KANSAS.

W. S. Ezell, 9 YE, Wichita
Karl Keller, 9 ADE, Kinsley

LOUISIANA.

P. E. Grenlaw, 5 BB, Franklinton

MASSACHUSETTS.

R. T. St. James, 1 IZ, Great Barrington
P. C. Smith, Haverhill
E. B. George, 1 ANA, Framingham
B. H. Moran, 1 AAM, Natick

MINNESOTA.

Peter Hansen, PH, Chisolm

MICHIGAN.

J. L. Munger, LM, Sturgis
W. Benson, 8 ANR, Battle Creek
Ed. Holby, 9 OE, Marquette
Y.M.C.A., 8 QJ, Ann Arbor
M. B. Rann, 8 ADR, Lansing
W. Koivanen, WK, Chisolm
D. G. Carter, 8 WR, Grosse Point

MISSOURI.

W. Corwin, 9 ABD, Jefferson City
Washington University, 9 XV, St. Louis
H. Longmire, Monroe City
B. Emerson, Monroe City

MARYLAND.

C. E. King, 3 SV, Baltimore
E. B. Duvall, 3 AK, Baltimore
A. P. Smith, 3 AK, Baltimore
L. W. Passano, Marconi Operator, M. & M. Co., Baltimore

MONTANA.

A. C. Campbell, 7 ZC, Lewiston

NEBRASKA.

Bradford Telepea, No Call, Tekomah

NEW YORK.

J. N. Simpson, 8 CM, Rochester
W. C. Ballard, 8 XU, Ithaca
Genesee Radio Station, 8 OZ, Rochester
Dr. H. E. Fitch, 8 ZE, Elmira
O. W. Saxton, 8 FY, Buffalo
A. C. Young, 8 ARB, Buffalo
H. Blower, 2 HB, Brooklyn
Kenneth Briggs, 8 MG, Rochester
J. Weiss, 2 FH, Port Washington
G. M. Benas, 8 CC, Utica
W. J. Vickery, 8 SE, Gloversville
J. K. Hewitt, 2 AGJ, Albany

NORTH CAROLINA.

W. S. Rothrock, 4 DI, Winston Salem
J. T. Moorehead, JM, Greensboro

OHIO.

Fred Travis, Defiance
R. Hoffman, Defiance
D. Israel, 8 ANC, Cincinnati
G. D. Howsare, 8 ASG, Eaton

(The balance will be published in the June issue.)



The Mark-o' Quality

is a storage battery.

An Opportunity for Experimenters

to secure a GOOD storage battery at a moderately LOW cost. The ONE article you cannot afford to experiment with

MARKO STORAGE BATTERIES

MARKO storage batteries are especially adapted for operation of all kinds of spark coils, insuring a heavy and powerful spark. There is nothing superior FOR AUDION USE.

Type	Volts	Amp. H.R Capacity	List Price	Special price to wireless engineers
4C2	4	40	\$ 7.00	\$4.90
6C2	6	40	10.00	7.00
6C4	6	60	12.00	8.40
6C6	6	80	16.00	11.20

PAUL M. MARKO & CO., Inc., 1191 Bedford Ave., Brooklyn, N.Y. N. Y. Depot—974 8th Ave., N.Y. City

New Undamped Wave Coupler No. 749

Special Introductory Price, \$18.00

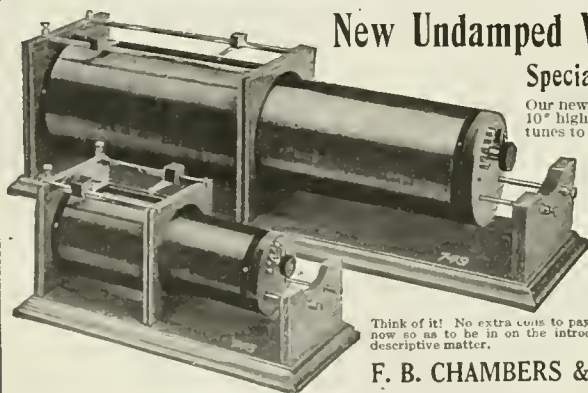

Our new coupler No. 749 is 32" long, 9" wide, and 10" high, over all, and on an average-sized Antenna tunes to 15,000 meters. This coupler, used with the new CHAMBERS' SYSTEM or CIRCUIT, will bring in signals from domestic and foreign Arc Stations surprisingly loud and clear. Note the difference in size of our No. 748 and No. 749.

We claim to be the original inventors of a SYSTEM or CIRCUIT for the reception of the undamped waves without the use of Loading Coils or Oscillating Coils, as they are sometimes called; as with our SYSTEM or CIRCUIT only two Inductively Coupled Coils are necessary. Circuit supplied with each coupler.

This CHAMBERS' CIRCUIT saves you money, now so as to be in on the introductory price. Orders filled in rotation. Send for descriptive matter.

F. B. CHAMBERS & CO., 2046 Arch St., Phila., Pa.

"THERE'S MONEY IN IT"

LEARN TELEGRAPHY AT HOME

MORSE AND WIRELESS

TEACH YOURSELF

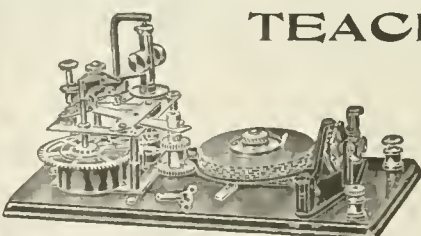

In half the usual time, at trifling cost, with the wonderful Automatic Transmitter, THE OMNIGRAPH. Sends unlimited Morse or Continental messages, at any speed, just as an expert operator would.

Adopted by U. S. Gov't. 4 styles. Catalogue free.

OMNIGRAPH MFG. CO.
39L Cortlandt St. New York

Are You An American?

Are you with the country or against it? If you own a radio outfit it behooves you as a patriotic American to offer your Wireless Station to your country. You do not obligate yourself in any way by signing the blank printed below, except that you give the Government permission to operate your station at any time its officials may see fit to use it.

Thousands of Amateurs have thus pledged their stations, WHY NOT YOU? Sign the blank to-day, and it will be promptly forwarded to Washington. (See also page 3, this issue.) Join the *Radio League of America*; no fees, no dues to be paid. By joining you get a free membership certificate printed in green and gold. Send stamp for large eight page information booklet. Radio League of America, 233 Fulton Street, New York City.

Application for Membership in the Radio League of America

I, THE UNDERSIGNED, a Radio Amateur, am the owner of a Wireless Station described in full on the face of this application. My station has been in use since....., and I herewith desire to apply for membership in the RADIO LEAGUE OF AMERICA. I have read all the rules of the LEAGUE, and I hereby give my word of honor to abide by all the rules, and I particularly pledge my station to the United States Government in the event of war, if such occasion should arise.

I understand that this blank with my signature will be sent to the United States Government officials at Washington, who will make a record of my station.

Witnesses to signature: Name..... City..... State..... Date.....191

Describe the apparatus of your station on the blank below.

In the event of national peril, you will volunteer your services as a radio operator in the interest of the U. S. Government?.....

This last question need not be answered unless you so desire it.

Description of My Station and Apparatus

Sending Receiving (5-17)

CUT OUT, FILL IN, AND RETURN AT ONCE

DISTRIBUTED CAPACITY AND ITS EFFECT.

(Continued from page 33)

of the June 1916 issue of this journal. For those who have not seen this copy, the accompanying reproduction is made, Fig. 5. The construction is very simple and the drawing is self-explanatory.

The effect of distributed capacity and dead-end effect is more pronounced in long coils and it is advisable to wind such coils in sections as shown in Fig. 6. It has been found that a considerable amount of distributed capacity is eliminated by such a

method of winding and it should be done in every case where it is possible, especially on secondaries of loose couplers. The reason for reducing the distributed capacity is self-apparent, as the capacity varies inversely as the thickness of the dielectric between the conducting mediums. Thus the capacity is reduced by increasing the distance between sections. It will be an ideal inductance if each turn of the coil is separated from its neighboring turn, say, one-thirty-second of an inch each. The distributed capacity of such a coil would be very small as compared to a coil with the wires close together.



"You Get The Job"

"We've been watching you, young man. We know you're made of the stuff that wins. The man that cares enough about his future to study an I. C. S. course in his spare time is the kind we want in this firm's responsible positions. You're getting your promotion on what you know, and I wish we had more like you."

The boss can't take chances. When he has a responsible job to fill, he picks a man trained to hold it. He's watching you now, hoping you'll be ready when the opportunity comes.

The thing for you to do is to start today and train yourself to do some one thing better than others. You can do it in spare time through the International Correspondence Schools. Over 5000 men reported advancement last year as a result of their I. C. S. training.

The first step these men took was to mark and mail this coupon. Make your start the same way—and make it right now.

I. C. S., Box 5346, Scranton, Pa.

INTERNATIONAL CORRESPONDENCE SCHOOLS

Box 5346, SCRANTON, PA.

Explain, without obligating me, how I can qualify for the position, or in the subject, before which I mark X.

- ELECTRICAL ENGINEER, MECHANICAL ENGINEER, CIVIL ENGINEER, ARCHITECT, CONTRACTOR AND BUILDER, AGRICULTURE, SALESMANSHIP, ADVERTISING MAN, CIVIL SERVICE, RAILROAD, ILLUSTRATOR, DESIGNER, BOOKKEEPER, STENOGRAPHER AND TYPIST, COMMERCIAL LAW, GOOD ENGLISH, TEACHER, COMMON SCHOOL SUBJECTS, CIVIL SERVICE, RAILWAY MAIL CLERK, AGRICULTURE, TEXTILE OVERSEER OR Supt., NAVIGATOR, POSTOFFICE, AUTOMOBILES, AUTO REPAIRING, ITALIAN

Name..... Occupation & Employer..... Street and No..... City..... State..... If name of Course you want is not in this list, write it below.

You benefit by mentioning "The Electrical Experimenter" when writing to advertisers.

Electric Light for Your Home

The Uni-Lectric is a complete electric service station in home size. Generates standard 110-volt direct current. Big capacity—operates one to 50 lights, electric motors up to 1 h. p., electric irons, electric heaters, vacuum cleaners, force pumps, churns, separators, washing machines, etc.—24 hours a day, every day in the year if you wish. Uses standard lamps and fixtures.

No Belts—No Batteries

Our patented, high-speed, rotary eleven valve engine operates the modern, high-speed generator with such smoothness that all necessity for storage batteries is eliminated. Thus the renewal of batteries and battery upkeep cost is entirely done away with. Outfit comes in one small compact unit, ready for quick installation. Simple, dependable and economical. The entire outfit guaranteed for five years. Write today for free copy of our new catalog on farm lighting plants.

Waterman Motor Company

112 Mt. Elliott Ave. Detroit, Mich.

The only home size lighting plant that operates without storage batteries.



NO MONEY DOWN **2 CREDIT \$2 A MONTH** **ALL \$2**

Genuine 15-17-19-21- Jewel Elgin, Waltham, Howard, or any watch you want, send for FREE CATALOG

98 pages of wonderful values, diamonds, watches, rings, jewelry, up-to-date designs. Buy the Ware Way, you will never miss the money. Get posted, write today.

ALFRED WARE CO., Dept. 705 St. Louis, Mo.

ACORN UNI-LITE

Turns night into day. 300 candle power. Carry as a lantern; use anywhere as a lamp. Weather proof. For house, barn, garage, camp and around the farm. Write for big, free offer. Special opportunity to farmers, stockmen and motorists. Agents make big money. Write tonight for new 1917 offer.

ACORN BRASS MFG. CO., 22 Uni-Lite Bldg., Chicago

TYPEWRITERS

\$10 and Up All Makes Save \$25 to \$50

Rebuilt at the factory by the well-known "Young Process." Sold for low cash—installment or rented. Rental applies on purchase price. Write for full details and guarantee. Free trial.

Young Typewriter Co., Dept. 176, Chicago

ELECTRICITY

I can teach you by practical work the Electrical profession in your own home. Short time required and easy payments. MATERIAL and TOOLS FREE. Write me to day for free book on Electricity.

L. L. COOKE, Dept 21

439 Cass Street CHICAGO, ILL.

\$200 and You Get This Superb Cornet

An astounding offer. Pay the balance at the rate of 10¢ a day. Free trial before you decide to buy.

WURLITZER FREE Band Catalog! Send us your name and address. The 250-page book is free. Thousands of instruments are shown. Rock-bottom prices—easy payments. Generous allowance for old instruments. We supply the U. S. Gov't. Write today.

THE WURLITZER CO., Cincinnati, O. Dept. 745 Chicago, Ill.

Free Carrying Case with this \$200 superb Triple Silver Plated Wurlitzer cornet, genuine leather. Write today.

EDDY CURRENTS.

(Continued from page 21)

as one of the fleet when the war had broken out. I tried to ask him questions, but he was as clammy as Parker and I could get nothing out of him.

What was behind that locked steel door? Was the means of destroying the enemy's ships concealed there? What was this curious torpedoless means? I wanted to ask Parker, but pride and shame at my own stupidity held me back. So I wondered and pondered and puzzled all that day.

Thought of the affair was dispelled when about sundown the lookout sighted an enemy aeroplane dead ahead and some distance aloft. We immediately sank to the awash condition and then as the plane grew near, we submerged with only our periscope showing. This we drew in as we noted that the aeroplane sighted us and swooped down for a look. We ran submerged for a half hour or so and then cautiously poked up our periscope.

There was a sudden cry of warning from the man at the instrument and we dove again. There had been an enemy torpedo boat destroyer near, and even in the dusk it was not safe to come up when any of these craft were about. We had been sighted we knew, for its searchlights made the water dimly translucent above us. But we submerged below the light and ran still east by north.

It was just after this that I noticed that Billy came to the feeler case. I heard him give directions that the small alternator which supplied the coil with current, should be started. Then he worked the two control wheels, and by glancing over his shoulder at the dials I saw that he was sweeping the coil from side to side, and frequently changing its inclination. By this means he was throwing out an arm of magnetic force which would indicate the position of any enemy ship within ten thousand yards.

"Hunting for fish?" I asked.

"Yes, I'm feeling for them," he answered, watching the angle of the horizontal gage, and then turning to me with a twinkle in his eye. "Have you solved it yet?"

"No, I haven't," I admitted.

"You watch tonight then," he said. "We're about due to be in the enemy's fleet and we ought to have some experience at least."

The light on the case before him flashed suddenly red, and the dial needle marking distance jumped up to eight thousand and stopt there. He turned and held the horizontal control wheel stationary a moment.

"We're in them now," he said. "There's the first one."

There followed a most wonderful piece of manuevering. He turned the coil until he was sure of the position of the enemy, and then changed the course of our boat to correspond to his. Slowly we worked around, the little coil giving us the position of our foe with its unerring magnetic touch.

In half an hour we were making twenty-two knots west by south and running thirty feet under. The enemy was off to starboard according to our indicator.

"He must be a battleship. Twenty-two is too slow for anything else," Billy said.

I agreed and a moment later, with a final assurance that our courses were parallel, Billy turned to a locked case beside the feeler box. I glanced at the dial. The enemy was just 1436 yards away according to our readings.

Billy was opening the case which looked exactly similar to the feeler, but lacked the lamp and distance dial and had only

two control wheels. Under it was a small electric pushbutton whose function I could not understand.

He twisted the control wheels for a moment until the dials read the same as those of the feeler. Then he called down the speaking tube.

"Start the alternator."

"Yes, sir," came back Dickenson's reply. I heard faintly above the other machinery the starting crescendo of a turbine. "Here goes for a trial," Billy said.

I watched him, and with a final glance to make sure that both dials corresponded, he deprest the button. The machine forward, the alternator, I thought, dipt several notes in its hum and then rallied. The button was down for four or five minutes and then he let it up and gave the command to stop the alternator.

What had he done? Had this deprest button let loose some mysterious new force, some wonderful ray, some hitherto undiscovered ethereal vibrations which could travel through water and destroy the enemy ship alongside us? What had he done when he prest that button? I wanted to ask him, but again pride and chagrin stopt me.

Instead I went to my instruments, thinking that I might pick up some of the enemy's talk and hear something worth knowing. To this purpose I juggled my tuner knobs, getting many and rapidly changing combinations with the sliding contacts.

It was while doing this that I heard a sudden loud buzz in the receiver. I held the adjustment there a moment and heard several letters, apparently forming a foreign word. Then I listened while a message in the enemy's tongue was spelled off loudly into my receiver. I wrote it down as it came. When it had stopt and I had translated it, I had before me the following:

"The fire in the forward port compartment, No. 7, is in the oil tanks and is so hot that it has melted out a section of the hull plates. We have a heavy list to port, but are not in immediate danger. Good luck.

"Captain Von Heissburg,
The Stoltzenfels."

That looked as if there was trouble in one of the enemy's ships. I showed the message to Billy.

He read it over twice and then glanced up with a gratified light in his face.

"Pretty good, but not quite enough," he said. "Have to use more next time I guess," and he turned away to the feeler case.

I could make nothing of this remark and did not try to. I was too busy watching him again.

Once more he was sweeping with the feeler. We were bearing off to the south and running slowly. Again the light flashed and he twisted controls and helm until we ran parallel with the enemy, 43 yards away and off his starboard side. Once again we were thirty feet under and running at twenty-two knots, which seemed to be the speed of the fleet. As before Billy twisted the controls on the other and un-named case until the dials read the same as the feeler. Once again he called the order to start the alternator. The hum of the machine sounded and as before the button was prest. I timed it now and found that it was held down six and a half minutes.

Then we sheered off to the south, slowing up and letting the enemy pass ahead of us.

I watched again in intense but unsatisfied curiosity while Billy twisted and turned the little wheels and after our boat came parallel to the enemy, prest the

button after having the alternator started. Fourteen more times it happened that night, while we maneuvered and changed our course to get into position. I did not get a chance to ask him that night. He was busy and the gratified light was too strong in his face, and I knew from all signs that I would only encounter more teasing.

So I stood by and watched and wondered what mysterious force was being loosed when he prest that button. Was it intensified wireless waves? I listened at my receivers once to make sure of this theory, but heard nothing. So I gave it up and watched and waited to let him tell me in his own way at his own time.

The next morning we had cruised for two hours without catching anything in the meshes of our magnetic net and Billy was about to give the order to come to the surface when we picked up something off our port bow. We slowed down to fall in with it, since it seemed to be running slower than we. After a few moments we found that it was stationary. We ran around it three times and then running several hundred yards away from it, Billy gave the order to come up cautiously.

The rising periscope flasht the picture, the scene that was there, spread on the water in the early morning light. I saw it over Billy's shoulder in the mirror.

It was a proud battleship, or had been, now leaning far over to port and surrounded by a bevy of small boats filled to overflowing with men. The great guns were pointing wryly skyward, and gave it a ridiculously helpless air as it lay there, rolling heavily in the swell of the sea.

"Its the Stoltzenfels," Billy said, looking intently into the mirror.

Then I remembered the message from her captain which I had overheard last night. I was about to mention this when I saw that the men in the boats had sighted us and were now pointing to us and signaling to the battleship. One of the great turrets swung about drunkenly and then we dove. We ran under the ship and her boats and then away to the west.

"Let them go. They can't hurt anything with that leaky tub. That's the one we experimented on and didn't give enough to," Billy said.

We ran that morning with our periscope and breather pipes out of water, but ready to sink unseen if necessary. We saw nothing of the enemy, but about nine o'clock while at the receivers I caught this message:

"Captain Rollins, U.S.N. Aviation Corps. Have sighted much wreckage and hundreds of enemy boats filled with men. Also life rafts and other floating objects with men clinging to them. Sighted the Stoltzenfels leaking badly, and with many boats. Caught glimpse of few transports, but kept away by destroyers. Send cruisers and destroyers out at once. Battleships seem lost. Lieutenant Fletcher, Aviation Corps No. 7."

This I knew came from the wireless of one of our big scoutplanes which had been sent out to watch the movements of the enemy fleet.

I showed it to Billy Parker. He read it and his face lit with satisfaction in spite of the fatigue of the sleepless night.

"Good," he shouted, "we got them all right, didn't we? We got 'em, the country's saved, we got 'em!! We got 'em!!!"

He capered about in the mess room, in a manner quite unbecoming for an officer and a man of his years.

"But how did you do it?" I begged, following him about in his joyous antics, and daring to broach this subject again in the face of his good humor.

MULTI-AUDI-FONE

SPECIAL NOTICE

We have just placed on the market a new loose coupler built of mahogany with all metal parts highly polished nickel plate.

New in design and wonderful in efficiency.

Made in two sizes.

Type "AD" 150 to 3000 Meters \$ 6.50
Type "AU" 4000 to 15000 Meters \$12.00

Multi-Audi-Fone.....	\$ 18.00
Two Step M. A. F.....	75.00
Short Wave Regenerative Attachment.....	22.50
Multi-Form Receiver...	100.00
Detectorphone.....	35.00
Fixed Condenser.....	1.00
M. A. F. Detector.....	3.00
M. A. F. Loading Coil.	2.00

MULTI-AUDI-FONE

275 Morris Ave.

Elizabeth, N. J.

Send 2c. for Circular

UNIVERSAL ELECTRIC MOTORS

OPERATING ON A. C. OR D. C.—110 TO 130 VOLTS

1/40 TO 1/8 H. P.

CATALOGUE FREE



TYPE AK
\$6.00



THIS MOTOR \$6.00
1/20 H. P.—6000 R. P. M.

Being Used Successfully for Grinding, Polishing, Driving Small Machinery, Sewing Machines, Fans, Wireless Spark Gaps, Electric Fountains, Check Enders, Humldors, Valve Grinders, Electric Hair Clippers and numerous other appliances.

A MOTOR OF UNIVERSAL APPLICATION
Base Pulley and Chucks Easily Detached

Complete with Pulley Emery Wheel Buffing Wheel Chucks Cord and Plug

IF YOUR DEALER CANNOT SUPPLY YOU, ORDER FROM US DIRECT.

RACINE ELECTRIC SALES CO.
304 South Dearborn Street CHICAGO, ILL.



Packard

WIRELESS TRANSFORMERS

are enabling many amateurs to cover 700 to 900 miles and come in strong white complying with all government regulations.

Let us tell you how you can do part of the work yourself and get one of these excellent transformers at a remarkably low cost.

The Packard Electric Company

WARREN OHIO

Write Dept. EE

Use Bunnell Apparatus

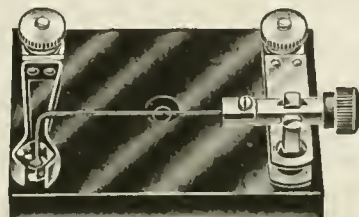

No. 8804 Jove Crystal Detector Holder
On Dark Porcelain Base . . . \$1.20
On Handsome Composition Base . . . 1.50

Best and most durable. Up-to-date dealers have them in stock.

Our Catalog 36E illustrates and describes about 300 articles of wireless apparatus as well as other appliances. Send 2c stamp for it, to

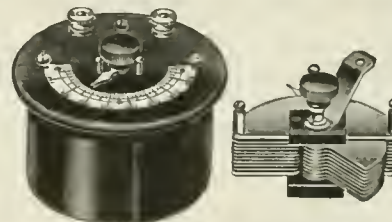

No. 8654 Dandy 21 Plate Variable Condenser \$3.90

J. H. BUNNELL & CO.'S

Radio Dept.

32 Park Place New York

DO YOU NEED Audion Requirements?

Look Over This List, Then Send Us Your Order PEERLESS SILENT SWITCH—This is something new, a controlling device for the audion "B" battery. It is far superior to any potentiometer, in that it does not wear out or short circuit the batteries. Silent in operation, moulded in pure formica, silver plate used thruout. Complete with knob, lever, and packed in a neat box, and sent prepaid for \$1.50 INTERIOR CONTROLLED RHEOSTATS for use on cabinets where knob and pointer only are visible, complete for \$1.40 45 VOLT "B" battery standard make 2.35 COMPLETE AUDION SET, MOUNTED ON GENUINE FORMICA, with "B" battery and hub, great bargain, only \$11.50 SPECIAL AUDION GRID CONDENSER. Exact capacity 45c AUTHORIZED AGENTS FOR: "Paragon Short Wave Set," "Tigerman Detecto-Amplifier," "Moorehead Tubes." Double filament audion tubes, each one separately tested, carefully packed, fully guaranteed or money back. Sent prepaid for \$5.00. This is positively, the most sensitive vacuum valve on the market! Order now before you forget it.

Send 10c for our catalogue which contains: Audion cabinets, rotary caps, rotary quenched gaps, detectors, oil immersed condensers, amplifiers, and biggest assortment of parts on the market. Oscillation and Thordarson transformers.

Mid-West Wireless Mfg. & Sply. Company, Mattoon, Illinois

414 PAGES 145 ILLUSTRATIONS



ELECTRICITY!

HERE'S just the book on Electricity that you need to answer your many questions—to solve your knotty problems, to teach you new kinks, to be your memory for tables, rules, formulas and other Electrical and Mechanical facts that some people try to carry in their heads—and fail. With this "Little Giant" I. C. S. Electrical Engineer's Handbook in your pocket, tool chest, on your work bench, drawing table or desk, an hour or a day need not be lost "digging up" some forgotten rule, some unfamiliar fact; you'll just turn to the very complete index and get it "in a jiffy." Just a few of the subjects treated are:

- Electricity and Magnetism; Electrical Symbols; Batteries; Circuits; Magnets; Direct and Alternating Currents; Dynamos and Motors; Belts; Shafting; Electroplating; Electrical Measurements; Meters; Arc and Incandescent Lamps; Mercury Arc Rectifiers; Transformers; Insulation; Electric Cars; Single and Multiple-Unit Control; Transmission; Rail Welding; Tables of Wires—Sizes, Capacities, etc.; Mathematical Rules, Formulas, Symbols; Tables of Constants, Equivalents, Roots, Powers, Reciprocals, Areas, Weights and Measures; Chemistry; Properties of Metals; Principles of Mechanics; First Aid, etc.

The Electrical Engineer's Handbook is one of 22 I. C. S. Handbooks covering 22 Technical, Scientific and Commercial subjects, all crowded with value. They have the contents of a full-size book condensed into pocket-size ready to go with you anywhere and be at your instant command. They are substantially bound in cloth, red edges, goldleaf stamping, printed from new, clear, readable type on good quality book paper. There is an illustration at every point where a picture will help. Hundreds of thousands have been sold on a money-back guarantee of satisfaction.

The regular price is \$1.25, but for a LIMITED TIME you can buy the ones you want, post-paid, delivery guaranteed, for only 50 cents.

You Run No Risk! Money Back if Desired! International Correspondence Schools Box 53 44, Scranton, Pa.

INTERNATIONAL CORRESPONDENCE SCHOOLS Box 53 44 SCRANTON, PA.

I enclose \$_____ for which send me postpaid the Handbooks marked X, at 50c. each. I may return any or all and get my money back within ten days from receipt:

- Electrical Engineer's
Teleph. and Teleg. Engineer's
Mechanic's
Steam Engineer's
Washing Machine Air Brake
Civil Engineer's
Coal Miner's
Concrete Engineer's
Building Trades
Plumbers and Fitter's
Chemist's
Advertiser's
Business Man's
Bookkeeper's
Steno. and Correspondent's
Salesman's
Window Trimmer's
Cotton Textile Worker's
Farmer's
Poetryman's
Mariner's
Automobile

Name _____
Street and No. _____
City _____ State _____

"You poor stupid blockhead," he laughed, slapping me on the back, "don't you see yet?"

"No, I don't see at all," I admitted. "Let me tell you so you can wireless the whole thing back to the papers. You understand how that feeler works?"

"Yes, perfectly," I said. "Well, up on the bow we have a big coil just like that, mounted on a universal joint so it can be raised or lowered or swung around at any angle in the vertical or horizontal, except directly back. That coil takes about two thousand kilowatts of current which is supplied to it by a big alternator put in the old torpedo room forward."

He paused. "Well?" I demanded. "Don't you see now?" he asked. "No, I don't, go on," I commanded. "Oh, man, you haven't a bit of imagination," he groaned.

"Well, we can swing this coil around and send a current thru it," he went on. "If an enemy ship comes within one hundred yards of us, the same thing will happen that happens in an induction furnace. We can send enough eddy currents thru his hull to melt out a whole section of the plates. Now do you understand?"

But I was at the key, pounding out the message.

COMBATING THE TORPEDO.

(Continued from page 11)

hand on Detonator switch No. 1, he calmly waits. When the hostile torpedo is but ten feet distant from motor torpedo No. 1, he throws the switch. There is a terrific explosion and a huge column of water is thrown up several hundred feet into the air. Motor torpedo No. 1 has vanished, so has the enemy torpedo. The ship for the time being is safe. Instantly the crew has lowered away a new motor torpedo to take the place of the one just destroyed and long before it touches the water it has been electrically connected to the control board. But this would be necessary only for a large ship with a very valuable cargo. A small steamer would have enough torpedoes left to cope with the enemy. By this time, too, enough time has elapsed for the ship to alter its course and run in a zig-zag line, making it very difficult for a submarine commander to hit the fleeing vessel with the next torpedo. But in case of necessity the other motor torpedoes are still "in the ring" to successfully grapple with the enemy. Even where two torpedoes are sent simultaneously against the ship the scheme will work out satisfactorily. In that case the operator at the control-board simply has to work two rheostats and two detonator switches instead of one and given a level head and a good eye for calculating distances and speeds, the task is not such a very difficult one.

There are a number of firing positions and schemes and while as a rule only one motor torpedo would be used to destroy the enemy torpedo, Fig. 1 shows how two motor torpedoes could be brought close together (see dotted lines of No. 1) to intercept the deadly missile. In that case torpedoes No. 1 and No. 2 would be freed simultaneously and leave little chance for the enemy torpedo to escape.

It is, however, not always absolutely necessary to actually destroy the hostile torpedo. Suppose that the submarine fires from a close range, and suppose that the selected motor torpedo cannot be speeded up fast enough—even by overloading its motor 100 per cent by raising its voltage—to come closer to the enemy torpedo than, say, thirty feet. Even in such an extreme case—the quite possible in rough weather—the control operator fires his tor-

(Continued on page 70)

HIGH VALUE PATENTS

—the ONLY kind Wanted and BOUGHT by Manufacturers. Send 8c. postage for new book of Extraordinary Interest to Inventors. R. S. & A. B. LACEY 63 Barrister Building, Washington, D. C.

Inventions Wanted! Manufacturers constantly writing us for patents. List of inventions actually requested and book "How to Obtain a Patent" sent free. Send rough sketch for free report regarding patentability. Special assistance given our clients in selling patents. Write for details of interest to every inventor. Chandlee & Chandlee, Patent Attorneys Est. 21 Years 950 F St., Washington, D. C.

PATENTS THAT PROTECT AND PAY Books and Advice Free If you want to sell your patent, take it out through my office. HIGHEST REFERENCES. BEST RESULTS. WATSON E. COLEMAN, Patent Lawyer 624 F. Street, N. W. Washington, D. C.

MONEY IN PATENTS We secure your patent or return our fee. Send sketch or model for free search of Patent Office Records and report on patentability. Manufacturers are writing for patents secured through us. Write for free book, "How to Secure Your Patent," and list of patents wanted. We assist in selling your patent. P. H. PATTISON & CO., U. S. Patent Attorneys 427 Barrister Bldg., Washington, D. C.

WANTED-IDEAS Manufacturers are writing for patents procured through me. FREE: 72-page guide book, "Successful Patents"; "Stepping Stones" (containing hundreds of inventions wanted); and "Patent Promotion," (tells how to sell your rights; chief causes of failure, etc.) Send for them. Free manufacturing facilities. Advice free. RICHARD B. OWEN, 164 Owen Bldg., Washington, D. C.

Electricians Get up-to-date IN HOUSE WIRING! Save TIME, MONEY-LABOR and MATERIAL by using our 98 GENUINE BLUE PRINT DRAWINGS, containing all the latest diagrams and connections known in house wiring—every diagram and connection up-to-the-minute as used by first class electricians for wiring BELLS, BURGLAR ALARMS, LIGHTS, ANNUNCIATORS, FIRE ALARMS and ELECTRIC GAS LIGHTING. These drawings are bound in the form of a flexible book (9 x 12) for convenience in using on the job. Send for them, and if they don't make you more efficient as a wireman and save you many times their cost as a contractor, return them and money will be refunded—you can't afford to be without them. ONE DOLLAR post paid. PATENT SPECIALTY COMPANY 462 Sanchez Street San Francisco, Cal.

SMALL ENGINES Perfected Gasoline Engines—1/2, 1 and 1 1/2 h.p.—for Farm and Shop use. Price \$19.50 and up. Also WASHING MACHINES We ship on trial. Send for Booklet and Special Offer Sieverkropp Engine Co., 1401 19th Street Racine, Wis. Starter for Ford Cars

THE MIDGET SLIDE RULE will add, subtract, multiply, divide, solve problems involving even and uneven roots and powers. It will also give the Logarithms of numbers and the Sines, Cosines, Tangents and Cotangents of all angles. Its operation is very simple and with this instrument you can quickly solve any mathematical problem. This slide rule is made of wood and metal and it is adapted for shop work as well as office use. Size 3 1/4 x 3 1/4 in. Price, with Instructions, 75c. Your money back if you are not satisfied. GILSON SLIDE RULE CO., Niles, Mich.

Learn Watchwork, Jewelrywork and Engraving. A fine trade commanding a good salary, and your services are always in demand. Address HOROLOGICAL Department, Bradley Institute, Peoria, Ill., for our latest catalog

PATENT ADVICE

Edited by H. GERNSBACK

In this Department we publish such matter as is of interest to inventors and particularly to those who are in doubt as to certain Patent Phases. Regular inquiries address to "Patent Advice" cannot be answered by mail free of charge. Such inquiries are published here for the benefit of all readers. If the idea is thought to be of importance, we make it a rule not to divulge details, in order to protect the inventor as far as it is possible to do so.

Should advice be desired by mail a nominal charge of \$1.00 is made for each question. Sketches and descriptions must be clear and explicit. Only one side of sheet should be written on.

SAFETY-FIRST OIL CAN.

(144.) John Brent Marshall, Cincinnati, Ohio, submits drawing and description of a, what he calls, safety-first oil can, and wants to know if it can be patented.

Ans. The idea as submitted contains nothing new to our mind and we are quite positive that no patent can be obtained on it.

LIGHT DIMMER.

(145.) Arthur Norris, Defiance, Ohio, has submitted a light dimmer which acts on the principle based upon the rotary potentiometer, the idea being to place a high resistance between supply wires and the light.

Ans. This is a very good idea and we are quite certain that the device can be patented. We have never seen anything like it on the market and providing the device can be made cheap enough and incorporated in a lamp socket, there should exist a good demand for same. We would advise our correspondent to get in touch with a patent attorney at once.

SPARK PLUG.

(146.) Clarence Melotz, Florence, Neb., submits what he calls a sootproof spark plug. The arrangement is such that the spark is supposed to keep a small cup from carrying carbon. Our advice is asked.

Ans. There does not seem to be anything new contained in this and at the present time there is a very similar spark plug on the market under the trade name of the "Soot-proof" spark plug.

PROPELLER.

(147.) Alison J. Kurth, Colorado Springs, Col., encloses sketch and description of a propeller for motor-driven boats. Instead of using a propeller, a certain perforated disc is used and our correspondent would like to know if we advise him to have it patented.

Ans. While this propeller no doubt works, it is impossible to determine its efficiency without actually testing it out, in practice. It is very doubtful to our mind, however, if this propeller should be more efficient than the regular one. In the absence of actual tests, we would not like to finally commit ourselves and advise our correspondent to try out the device in practice before applying for patent.

AUTOMATIC VOICE RECORDER.

(148.) Joseph Prochaska, Chicago, Ill., submits to us drawings and specifications of a novel idea, particularly for use by physicians whereby it is possible for a patient to call up the doctor while he is not at home and instead of the doctor answering, the phonograph does this for him, all automatically, telling the patient where the doctor can be located or when he will return.

Ans. The device is well worked out and while there does not exist an urgent demand for this invention, there is no doubt quite a number of people who would be

interested in owning such an apparatus. We think a patent might be obtained upon the mechanical features embodied in this device.

"PERPETUAL MOTION."

(149.) Percy Muirhead, Dayton, Wash., submits a scheme of "Perpetual Motion" in which is utilized a Radiometer which as is known, works by light striking it. He wants our opinion of this scheme.

Ans. There is no such thing as "Perpetual Motion" and by using a Radiometer, this rule is no exception, for the simple reason that the Radiometer employs light which is a form of energy, and for this reason the scheme cannot be termed "Perpetual Motion" and no patent could be obtained on the idea.

WINDOW ATTRACTION.

(150.) L. E. Summerton, Maryville, Tenn., has submitted to us a window attraction and he would like to know if it is worth while patenting. Also if there is a ready sale for such a device. The idea consists of an electrical arrangement whereby a small artificial bird acts as a woodpecker, pecking against a piece of wood every few seconds.

Ans. This is a very good idea and by elaborating it a little more, we are quite certain there would be a good market for a thing of this sort. By using a plurality of birds, a very interesting window attraction would be had.

WAVE MOTOR.

(151.) C. Mattison, Oakland, Calif., submits drawing and description of a wave motor to be used in the ocean to utilize the power of the waves. He wants to know what we think of it and whether it is practical.

Ans. There is nothing new contained in the idea, which is not a good way of solving the problem. The first requisite necessary for a good wave motor is that it must automatically adjust itself to the various water levels as the tide rises or falls. Such an idea was shown in our February issue from which it will be readily seen that the device will of necessity have to be somewhat complicated for best results.

U.S. PATENTS



FREE

BOOK-BULLETINS & ADVICE

REGISTERED ATTORNEYS

LANCASTER & ALLWINE

255 OURAY BLD'G., WASHINGTON, D. C.

Don't Lose Your Rights

We publish forms called "Evidence of Conception" by which you can establish your rights before sending the invention to anyone. It is your best protection. We issue up-to-date bulletins of improvements wanted, aid inventors to promote their rights; render reliable opinions free of charge and secure valuable patents and trade-marks on reasonable terms. Personal service assured by our **Service Guarantee Contract. References:** 2nd National Bank, Washington, The John P. Roth Packing Co., Cincinnati.

SIMPLY MAIL COUPON

LANCASTER & ALLWINE, 255 Ouray Bldg., Washington, D.C. Send me free book "Inventions—Patenting and Promoting," Bulletins of Improvements Wanted and blank form "Evidence of Conception."

Name

Address

PATENTS



Send Sketch or Model of Your Invention for Free Opinion as to Patentability

Our Certificate of Patentability is Evidence of Conception of your invention and may prove valuable to you. Our Credit System enables you to file your application for Patent and proceed without delay. Every case receives personal attention of one or both members of the firm.

Patents we secure advertised at our expense in Popular Science Monthly.

Write today for Free copy of 104-page-book "How to Obtain a Patent and What to Invent!"

Talbert & Parker, Patent Lawyers,
4287 Malbert Bldg., Washington, D. C.



R. MORGAN ELLIOTT & CO.

PATENT ATTORNEYS

MECHANICAL, ELECTRICAL & CHEMICAL EXPERTS

716-724 WOODWARD BUILDING

WASHINGTON, D. C.

PATENTS WANTED

Write for List of Patent Buyers who desire to purchase patents and What To Invent with valuable list of Inventions Wanted. \$1,000,000 in prizes offered for inventions. Send model or sketch for Free Opinion as to patentability. We have a Special Department devoted to Electrical Inventions and are in a position to assist and advise inventors in this field in the development of their inventions.

MODERATE FEES--WE ASSIST INVENTORS TO SELL THEIR PATENTS

Write To-Day for our Five Books sent free to any address. (See attached coupon:)

FREE COUPON!

VICTOR J. EVANS & CO., Patent Attorneys

NEW YORK OFFICES: 189-191 Broadway PHILADELPHIA OFFICES: 1429 Chestnut St.

Main Offices: 779 9th Street, N. W., WASHINGTON, D. C.

GENTLEMEN: Please send me FREE OF CHARGE your FIVE Books as per offer.

NAME

ADDRESS

**We Will
Send this
Book**

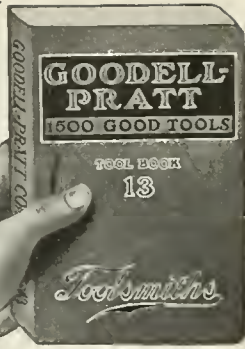

To any tool user who writes us, we will send free a copy of our 432-page book showing over 1500 Good Tools for all trades. You need it to keep posted on the new tools, and improvements in old ones.

Write for it now

GOODELL-PRATT COMPANY
Toolsmiths
GREENFIELD
MASS., U.S.A.

**See The World
And**



**Draw A Big Salary
As Wireless Operator**

Commercial and Marine

operators in great demand. Good opportunity for you in well paid pleasant profession.

**Highland Park Course
Very Thoro**

We teach how to build, install and maintain wireless stations. We also offer strong practical courses in Electrical Engineering.



Write today for free "Get There" booklet

HIGHLAND PARK COLLEGE
291 H. P. Sta. Dea Moines, Iowa

FREE Send for large Catalogue of **Practical Mechanical Books** FOR HOME STUDY

Best Books for Electricians, Telephone Men, Motion Picture Operators, Engineers, Railroad Men, Motormen, Draftsmen, Automobile Mechanics, Plumbers, Carpenters, Builders, Sign and Card Writers, also Bookkeepers and Civil Service Applicants.

F. J. DRAKE & CO.
Dept. 6, 1006 Michigan Ave.
CHICAGO

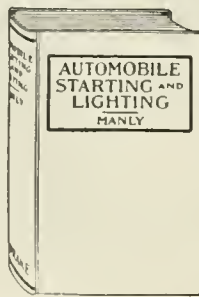

Sent Postpaid for \$1.00

COMBATING THE TORPEDO.

(Continued from page 68)

pedo anyway. The result is such a terrific as well as instant disturbance in the water that the enemy torpedo will be certainly deflected sufficiently from its original course so as to make it ineffective. And after all, this is what we want. For the enemy torpedo once it is spent, sinks automatically, because to leave it roam about the sea would constitute as much danger to its own submarine as to the attack vessel.

All the technical points have been worked out satisfactorily and while the basic idea can and will be no doubt improved upon, the reader can form his own opinion as to the practicability and effectiveness of the scheme.

The main point in its favor is that each torpedo can be built at a cost of less than \$1,000. For ten units this makes a cost of less than \$10,000 for a ship of 600 feet. This is pretty cheap insurance, considering that the cargo alone on such a ship nearly always is worth from three-quarters to one million dollars and often considerably more. The ship itself costs as much again. Besides if the vessel is protected adequately, the maritime insurance is reduced largely and no big bonuses need be paid to the crew, as is the case now.

The speed of the ship is not reduced by the motor torpedoes either, as they run independently, nor is the power to operate them very great. For ten torpedoes we require but 100 to 150 horse-power—a trifling amount for a 600-foot steamer developing some 20,000 to 30,000 horse-power.

Nor are the motor torpedoes used during the entire trip. Thus during a cloudy, dark night, during a fog, or in a very heavy sea there is no need for them, as a submarine cannot successfully torpedo a ship in such cases.

During these periods the motor torpedoes are hoisted out of the water by means of their steel covered cables and are lashed fast to the decks till needed.

As the torpedoes are fired by electricity, there is little danger from an accidental explosion, even if they should bump against the side of the ship occasionally, for instance during launching or in a squall. The distance of 50 feet of the motor torpedoes from the mother ship is necessary, for if they are exploded at a closer range than 30 feet they will damage the ship.

That the submarine commander sees the brightly colored torpedoes does not matter in the least. For he will soon learn that firing torpedoes at a ship thus protected is a waste of time and material. And then until something better is found, submarine warfare, to a large extent, will sink into a stalemate. And this is what we all desire.

A ship equip with guns (to prevent the submarine from using its own guns) and equip with motor-torpedoes as well stands little chance of being sunk.

It should be noted that our cover design is not strictly correct. First, the motor-torpedoes in practise run almost entirely submerged, leaving only part of the mast exposed. Secondly, the submarine is shown very much too close to the ship. These slight technically incorrect points were necessary to bring out the idea from an artistic standpoint.

GLADSTONE AND THE TELEPHONE.

The mental fatigue which would follow the introduction of the telephone was foreseen by the late Mr. Gladstone, England's grand old man. When he was asked by Mr. Edison's representative whether he would like to have a telephone apparatus set up in his house, he wrote on a post-card: "Sir, my means of communication from without inwards are already equal to my needs and in excess of my desires."

MAGNETISM PRODUCES RE-MARKABLE PHOTOGRAPHS.

(Continued from page 14)

like a line of latitude, no mere arrangement of the molecules of a magnet, can account for the result. There must be motion—currents of ether, for there is only ether under the receiver.

A detailed examination of the articles will strengthen this proof. The articles are lettered somewhat in the order in which the impression is made on the plate. Note that at A, but little, if any, impression is made on the plate—the currents could not penetrate—while J and K hardly show at all because the currents past thru them and affected the plate; and to pass thru or to penetrate there must be motion—currents. From A to K, it will be noted that the effect on the plate grows gradually stronger, showing that some are more penetrable than others and this degree of penetration implies motion. Note that D, E and F are penetrated less than G, and that G is penetrated irregularly, plainly showing the location of the acid pits on the surface of the zinc. None of these effects could be produced by light. Again, B and C are iron weights with cavities in the bottoms and openings thru the sides of these cavities. The weights were placed on the plates so that the cavities were downward. Yet these cavities show plainly in the plate. Light could not produce this effect, for in any event it would produce a shadow and enough light could not enter the small opening to effect the plate practically as much as the exterior. But currents of ether following the lines of the iron, as is the well known effect of iron in a magnetic field, could and did produce this result. Moreover, careful measurements show that the cavities are a little larger and the circumferences of the weights as shown in the plates are a little less, than in the weights themselves, conforming to the well known deflection or bending of lines in a magnetic field by the presence of iron. But the crowning proof is in H. Here is a wooden button showing the grain of the wood. The wood was penetrated more in some parts than in others. Light could not produce this effect for it could not penetrate the wood and if it were supposedly possible to bring to bear light strong enough to penetrate the button, it would penetrate all parts equally. The cracks and seams in J and K are shown in the same manner but in a less degree. Here then is unquestionably penetration, and penetration can not possibly take place without motion. Who would now question the existence of currents about the magnet?

Furthermore, here is incontestable proof that the lines of force, lines of tension, mere lines of direction do not "emerge from" (without motion) the North pole of the magnet, nor "pass to or enter" (again without motion), the South pole. The effect, the penetration, the currents are equal over both poles. These currents pass into both poles alike. They do not pass out from the poles for the plate is above the poles, both poles, with the sensitive side upward, and the objects are on the sensitive side of the plate above the poles. If the currents were passing upward from either pole, there would be no impression on the plate over that pole, for the current would pass thru the sensitive film before reaching the objects. Instead, it shows plainly that the currents past poleward equally over both poles, penetrated more or less the objects on the plate, affected the sensitive plate more or less according to

the amount of penetration, and then past on to the magnet. What then becomes of them will be shown later.

Still there are doubters. Could the result be due to stray light? Could it be due to phosphorescence? To radio-activity? Could the same result be obtained without the magnet? To answer these I placed a plate over a wooden "U" under the receiver, with the objects placed upon it exactly as before and used exactly the same precautions as in the first instance. At the same time and in the same room, far enough away not to effect the plate under the receiver, I placed a plate over the magnet with several objects upon it, but without a receiver, placed a light-tight box over this, and covered the whole with heavy folds of black cloth. In this instance the room was not opened for twenty-two days. At the end of that time both plates were developed with equal care under the same conditions as in the first case. The plate over the wooden support under the receiver was a *perfect blank!* There was no impression on it. The result with the plate over the magnet in the air is shown in Fig. 4. In this A is a key, B and C are pearl buttons, and D, E and F are wooden buttons. The grain of the wooden buttons can be seen as in Fig. 3 showing that the penetration is the same here but the whole plate demonstrating that the result is somewhat less clear, as might be expected, in the air than under a vacuum. The difference in the penetration at D and at E and F is accounted for by the fact that E and F were almost directly over the poles of the magnet while D was at one side and the penetration was much greater at E and F—again proof of the currents and of the effect of the magnet.

I have also produced Magneto-graphs, as I have chosen to call them, over an electromagnet and over a straight wire bearing a current, but I have not as yet secured clear results, owing to the difficulty of maintaining a steady current for sufficient length of time.

SOURCES OF ELECTRICITY.

(Continued from page 12)

As might be suspected, the voltage produced by heating a single metallic couple, such as the above, is very small, and where a greater potential is desired a large number of similar couples are mounted in as compact a manner as possible, and all of the junctions are heated simultaneously by gas or coal as shown in Fig. 6. The difference of potential for a bismuth-antimony couple is about 117 microvolts for each degree Centigrade, when the junction is heated above the rest of the circuit. The total current produced by the massive compound circular thermopile shown in Fig. 6 is 80 volts and 3 ampres, which is sufficient to light a number of incandescent lamps.

Dynamic Electricity: The most successful and practical source of electrical energy as we know it today is the *Dynamo*. One of these machines, which depends upon the cutting of magnetic lines of force by a rotating wire or *inductor* as it is called, is shown in Fig. 7. It was Faraday, who early in the 19th century discovered that if a circular copper disc be rotated between the poles of a strong steel magnet or an electro-magnet, that there would be a current produced, or rather *induced* in the moving copper disc, due to the cutting of magnetic lines of force. The current was found to flow from the shaft supporting the disc to the rim, or vice versa, according to the direction of rotation. This current was conducted away by wires, having sliding

The tool with 5 big features—

WHEN you thread pipe or conduit, do it with the least labor, bother and complication possible. For twenty-five years we have been specializing on pipe-threading—steadily working to reduce those three elements. The result is the

The Bull-Dog Line includes 11 tools, plain and ratchet, each threading from 4 to 8 sizes of pipe. Every civilized nation uses Oster Tools. The illustration shows Bull-Dog No. 102, threading six sizes, 1/4" to 1 1/4".



the tool with the 5 big features—
 (1) Self-locking, adjustable dies;
 (2) Self-centering guides, lever-operated;
 (3) Dies open up after cut (to lift off pipe without backing up) and reset automatically to size;
 (4) No loose bushings to lose or mislay;
 (5) No small, breakable parts.
 For all the facts in condensed form, ask for "The Bull-Dog Tale."

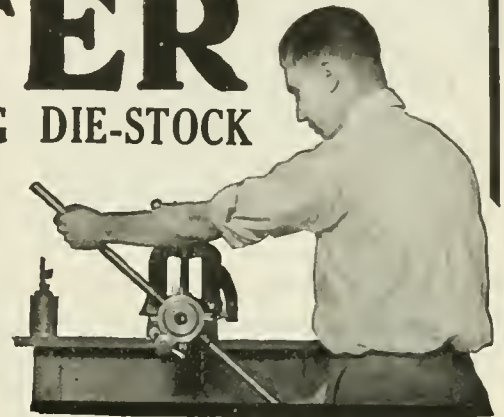

The Oster Mfg. Co.
 2141 E. 61st St., Cleveland, Ohio
 U. S. A.
 Makers of Oster Power-Driven Combination Threading Machines

Kindly send me (free) "The Bull-Dog Tale"
 Name
 Address
 City State
 Occupation (2141)

A GENUINE "RED DEVIL" GLASS CUTTER FOR 10c
 FOR THE ELECTRICAL EXPERIMENTER'S TOOL KIT



The most useful tool for making and repairing glass plates for wireless condensers. Also a handy household tool for repairing picture frames, windowpanes, etc.

Write for free Glass Cutter Booklet.

Smith & Hemenway Co., Inc., 107 Chambers St., New York City

brush contacts, one of which was made to bear against the shaft, while the other made contact with the edge of the disc.

It was not long before the simple copper disc gave way to the more modern *armature*, which contains a large number of insulated copper wires and all of which coils, in consequence, are caused to rotate rapidly in the powerful field of an electromagnet. These rotating coils are properly connected to a series of metal bars, assembled in ring form and known as a *commutator*, against which contact brushes bear, leading the current from the armature to the electric apparatus, such as lamps, motors, etc. The dynamo is always to be driven by some external prime mover, such as a steam engine, water wheel, etc. In the dynamo we have the conversion of mechanical energy into electrical energy.

ELECTRICITY FROM COAL: One of the most successful forms of apparatus for producing electricity direct from coal is shown in Fig. 8. This particular type of coal-electric cell is due to W. W. Jacques. Here we have a carbon cylinder immersed in a fused caustic soda bath; this is placed in an iron vessel which also serves as the other electrode of the cell. An air pump is employed to blow a stream of air thru the caustic soda by means of a perforated drum under the carbon rod. By means of the coal furnace the whole cell is maintained at a temperature of 400°C. The air stream has the effect of causing the carbon to ox-

TOOLS For shop, factory, garage and home—many high class tools attractively priced in our *Odds and Ends pamphlet* which is mailed free on request by

Montgomery & Co., Inc., 105 Fulton St., N. Y. City



Send for catalog of our tools for wood and metal. Also Mechanic's Handbook.
 MILLERS FALLS CO., Millers Falls, Mass.



WANTED—Railway Mail Clerks
 COMMENCE \$75 MONTH INCREASE TO \$150 MONTH
 Common education sufficient.

Sure pay.
 Life job.
 Pull unnecessary.

Franklin Institute
 Dept. B104 Rochester, N. Y.

Sirs: Send me without charge sample Railway Mail Clerk Examination questions; list of other big paid government jobs now easily obtainable and free book describing them.

COUPON
 Name
 Address



**Complete Control
In Your Pedals**

FOR quick or gradual action—the Corbin Duplex! At any time, in any place—the Corbin Duplex! On street and road, hill and dale, wherever and whenever control is required, put your trust in the dead sure grip of the famous



DUPLEX COASTER BRAKE

There is no qualification to this statement. The Corbin Duplex has built up its enviable reputation and universal popularity on the strength of its day-in-day-out dependable service.

You do not want any brake other than the best brake on that bicycle of yours and there is no need to experiment. The Corbin Duplex has shown what it can do and what it has shown has been sufficient to convince the majority of bicyclists that it is the most satisfactory brake on the market.

“Corbin Control Means Safety Assured”

For the old or new bicycle specify the Corbin Duplex. Sold and equipped by all dealers. Catalog on request.

The Corbin Screw Corporation
The American Hardware Corp., Successor
216 High Street, New Britain, Conn.
Branches: New York, Chicago, Philadelphia
Makers of Corbin-Brown Speedometers

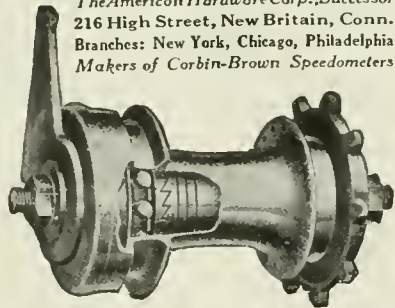

Convert Your Bicycle Into a Motorcycle



Motor fits any wheel. Best, most reliable. Best hill climber. More STEFFEYS in use than all others. A fine motor for running small Dynamos, Lathes and small shops. Motors only as low as \$16.95.



Steffey Mfg. Co., 5025 W. Brown St., Phila, Pa.

\$40 MOTORCYCLES

and BICYCLES at cut prices. Singles and twins \$25 to \$100. New Motorcycle Tires \$3. Automobile Tires \$3. Best Motorcycle Belts \$5. Carburetors \$6. Spark coils \$6. Second-Hand Bicycles \$5. Tandoms \$16. New Bicycles at Factory Prices.

Dentinger, The Price Cutter, Rochester, New York

idize to CO₂, which mostly bubbles up thru the caustic soda solution and escapes. This cell gives about 1 volt E.M.F. The action occurring in the production of electrical energy is believed to be partly voltaic and thermo-electric. The cell has an efficiency of about 8 per cent—compared to 12 to 15 per cent for modern steam boiler and engine plants, and the cost of raw materials to replenish it is said to be at least 34 times that for a good steam engine, while the residue or ash from such a battery would possibly weigh 12 times that from a corresponding steam plant.

PLANT ELECTRICITY: It is not generally known that certain plants exhibit pronounced electrical activity, but such is the case. Perhaps the strongest, that is in the sense of electrical vibrations, is the sensitive plant (*Mimosa pudica*), shown in the illustration (Fig. 9). Others, such as iris, nicotiana, nasturtiums and practically all the meat-eating plants, such as the “Venus fly-trap” and the “sundew,” afford splendid examples for experimentation. If any of these be placed “in connection with a galvanometer by means of electrodes attached to leaves on different sides, and one side of the plant be exposed to sunlight while the other side is kept shaded, then within from three to ten seconds after exposure to sunlight there will be a flow of electricity from the lighted to the shaded parts amounting to .005 to .02 volt. This continues for about five minutes, when the magnet begins to swing back and shows an opposite current of considerable magnitude. The manifestations are similar to those of “teranized nerve.”

A better understanding of the electrical qualities of plants will, no doubt, explain many of the hitherto mysterious habits of meat-eating plants. Especially will this be true of such terrible and uncanny plant monsters as the “devil’s snare” of South America and the mammoth *Utricularia*, or fishing plant, which lures minnows and small animals into its voracious mouth, and suddenly, as if an electric button were secretly prest, closes in upon its helpless prey. In other words, it fishes with a net electrically wired! Strange as it may sound this plant safeguarded itself by means of its electrical currents ages before we used the electric burglar alarm and door bell. Were it not for this protection, the plant could not live and hold its own in such an aural-infested region as it needs for its fishing ground.

ANIMAL ELECTRICITY: Altho not so commonly known, there are in the world several varieties of electric fishes and eels which possess quite remarkable power. Several species of these creatures inhabiting the waters of certain parts of the earth possess the power of producing more or less powerful electric discharges. Physiologically, the principal creatures of this class are the *Torpedo*, the *Gymnotus* and the *Silurus*. One of the most powerful electric fishes is the *Raia Torpedo* or Electric Ray, of which there are three species inhabiting the Mediterranean and Atlantic. This particular specimen is provided with an electric organ on the back of its head. The organ consists of laminae composed of polygonal cells to the number of eight hundred or one thousand, or even more, which is supplied with four large bundle of nerve fibers. The under surface of this fish is *negative*: while the upper surface is *positive*. With the *Gymnotus* or Surinam eel, the electric organ extends the whole length of the body from tail to head. It has been recorded by Humboldt that a lively combat ensued between a number of electric eels and a herd of wild horses, which were driven by the natives unconsciously into the swamps inhabited by the *Gymnotus*. This particular specimen of electric fish is said to be able



**Every Day’s a
Circus Day**

for the boy who rides a 1917
Electrically Equipped

**Indian
Bicycle**

Ridden wherever wheels are popular—and that’s everywhere this season—by boys who believe in getting for their money the most dependable construction, highest quality materials, greatest strength, finest appearance, and month-in-and-month-out service without the least bit of trouble. And those things hold good in every one of the eleven models of the 1917 Indian Bicycle line, for the Indian nameplate’s on ‘em all!

Indian Motorcycle effect throughout—Tank Battery Holder; Front Fork with Quadruple Crown and Braced Members; Indian Crank Hanger; motorcycle type Handlebars; big, comfortable Troxel Saddle; Coaster Brake; strong Rear Wheel Stand; Mud Guards; large Electric Light with powerful Reflector, so necessary in those states where the law requires that bicycles be lighted—the finest and most completely equipped Bicycle a boy ever owned.

Built and backed by the makers of the Indian Big Twin Powerplus and Light Twin Motorcycles and Indian Side Car.

Send for illustrated 1917 Indian
Bicycle Catalog

HENDEE MANUFACTURING CO.
826 State St. Springfield, Mass.
Largest Motorcycle Manufacturers in the World



**WIRELESS OPERATORS
SEE THE WORLD**

Positions always open. Good salaries. Day and evening sessions. Correspondence courses. Wireless apparatus for home use. Send 6c in stamps for catalog.

Phila. School of Wireless Teleg.
10 Parkway Bldg., Philadelphia, Pa.

Insist on getting the new 272-Page Edition of Edelman’s “EXPERIMENTAL WIRELESS STATIONS.” \$1.50, 2 lbs. postage, if you want the latest on audion circuits, long undamped wave sets, pots, etc. Order now from P. E. EDELMAN, Publisher, 1802 Hague Ave., St. Paul, Minn.

to give a most terrible shock, and proves a most formidable antagonist when it has grown to its full length of five to six feet. In the Silurus shown in our Fig. 10, the electric current flows from head to tail.

It has been shown by several scientists that nerve excitations and muscular contractions of human beings are the seat of slight electrical currents. For one thing it has been shown that the beating of the heart really creates rhythmical electro-motive force.

PHOTO-ELECTRICITY: One of the most interesting sources of electrical energy and also one of the most direct methods of production of electro-motive forces is found in the *photo-electric cell*. Simply explained this remarkable device comprises nothing more than two copper plates, one of which is perforated and blackened by oxidizing in a gas flame, while the rear or second plate is polished, and both of which plates are placed in a suitable tank containing a salt-water solution. One side of the tank which contains the copper plates is fitted with a glass window and when sunlight, or any other source of light, is allowed to strike the cell, there is a difference of electric potential set up between the front and rear copper plates. This particular cell as developed by Mr. Theodore W. Case, was described extensively in an article which appeared in the September, 1916, number of this journal. It was found possible with some of these photo-electric cells to obtain a voltage of one-tenth and an amperage of two-tenths; the cell delivering a steady current as long as the light shown on it. It is of course possible to connect a large number of cells in series or parallel to obtain any voltage or current desired.

RADIUM ELECTRICITY: It is generally conceded in scientific circles that the activity possessed by radium is fundamentally electrical in nature. Radium gives off three kinds of rays known as the *alpha*, *beta* and *gamma* rays. It is possible to influence two of these rays (alpha and beta rays) by means of a magnet or an electro-magnetic field, which indicates that they are undoubtedly electrical in their fundamental structure. Another experiment, which any schoolboy can readily perform with a piece of radio-active mineral, is as follows: First, an electric charge is produced on a sensitive gold leaf electroscope, so that the leaves diverge; then grasp a piece of the radio-active mineral (some may be so fortunate as to possess a tube containing a small quantity of radium bromid) and bring this into proximity with the metal ball or disc at the top of a charged electroscope. It will be noted that the latter loses its charge on the gold leaves almost instantly; the electronic activity of the radium bromid or other radio-active substance used creating a change in the electrical field about the electroscope, apparently making it more conductive, so that the bound electric charge on the gold leaves can escape. Those interested in the subject of "Radium" and the many electrical and other effects created by the greatest mystery of the scientific world to-day will do well to read the extensive article on this subject, which appeared in the September, 1916, number of THE ELECTRICAL EXPERIMENTER.

RADIO ENGINEERS DINE.

The Washington section of the Institute of Radio Engineers gave a dinner, March third, at the Commercial Club, Washington, D.C., complimentary to Brigadier-general George O. Squier, chairman of the Washington section. The following named gentlemen from New York participated: R. A. Weagant, chief engineer, and David Sarnoff, commercial manager, of the Marconi Wireless Telegraph Co., of America; Major J. Andrew White and W. J. Hernan, of the Wireless Press.

THE IONIC RADIO SYSTEM AND THEORY OF IONIC TUNING.

(Continued from page 31)

detector and Weston relay are here connected in multiple, the connections from the local side of the Weston relay being the same as above described.

The preferred type of my detector used in this system is shown in Fig. 5, and comprises large nickel-plated binding posts 16 and 17 mounted about two inches apart, center to center, on any suitable material so as to support the electrodes 19 and 20. To 19 a brass rod one eighth of an inch in thickness, is fitted a crystal of silicon 21, cut in the form of a truncated cone. Its base is glued to the rod, the electrical connection being made by wrapping the joint between the brass rod and the silicon with tinfoil. The electrode 20 comprises three inches of flexible cord, scraped of its insulation, then bent double and tightly twisted, the loose ends being cut off evenly. If the end of the silicon can be ground smooth without destroying its sensitivity a polished brass rod may be used.

This makes a detector costing about 35 cents to construct. It will have a highly finished appearance, exceptional reliability, unusual sensitivity and require very little adjustment, as the parts are fixed permanently in place. Those trying this form of detector resembling the early "E. I. Co." Auto-coherer I am sure will be well satisfied. After eleven years of experimenting with all forms of commercial detectors I have found this one the only type constant enough for quantitative measurements.

Having described one set of apparatus adapted to be operated according to my new method of tuning I will now briefly describe the characteristics of crystal detectors and the theory of operation of both *thermo-electric* and *ionic detectors*, in order more clearly to disclose the exact nature of my new method.

A Thermo Detector consists of a very fine point or "cat-whisker" resting upon a thermo crystal with a comparatively light contact. When an alternating current passes to and from the crystal, heat is generated in minute quantities at this point. This heat causes a "thermo-pile action" and generates a thermo-electro-motive force. Impulses of alternating current coming into the detector in such direction that their direction is the same as that of the thermo e.m.f. are allowed to continue and pass on thru the circuit. Those passing in the opposite direction are opposed by the thermo e.m.f. and are suppressed or *wiped out*. The impulses which reach our 'phones then are always in the same direction as the thermo e.m.f. Thus is accomplished the rectification by thermo crystal detectors. These crystals always require a metallic point and to this class of thermo crystals belong the following: copper pyrites, tellurium, manganese dioxide, chalcopyrites, galena, iron pyrites, etc.

Ionic detectors are also rectifiers but perform their function in a different manner, these metal points not being necessary and the form of contact being of relatively small importance. These detectors have no useful thermo e.m.f. A large polished plate of the crystal may be placed between two highly polished electrodes and it will work equally well, if not better, than with a point. I have taken a piece of molybdenite one-half inch in length and tacked it to a board with a tack at each end. It worked very well as a detector and required no adjustment. It was not especially sensitive but its operation was perfectly constant. On the contrary an ionic detector rectifies by the polarization of its contained ions, an ion being a combination of a number of positively charged molecules, with one negatively charged electron.

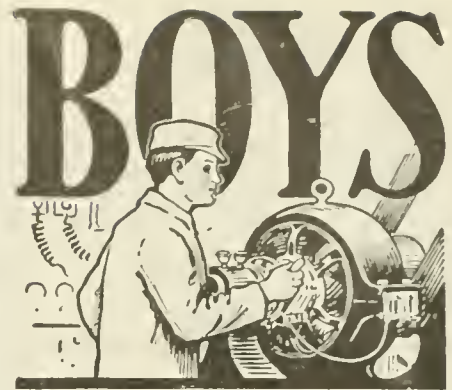

Big Money in Electricity

The electrical industries offer wonderful opportunities to boys with a liking for Electricity. The salaries paid to trained men are large, promotion comes rapidly and, best of all, the work is fascinating.

The discovery and development of new lines (such as wireless telegraphy and telephony), from time to time, promise attractive and paying fields to those who wish to specialize. The *will to do* and *Special Training* will bring success to you.

The International Correspondence Schools can help you to become an expert in electrical work, no matter what branch you like best. Thousands of young men have already won success through I. C. S. help. You can do as well as anybody, *if you try*. Everything is made so clear that you can learn in your spare time, regardless of where you live or what your work. No books to buy.

There's big money in Electricity. Get after it by marking and mailing the Coupon today. *Finding out costs you nothing.*

INTERNATIONAL CORRESPONDENCE SCHOOLS
Box 5345, SCRANTON, PA.

Explain, without obligating me, how I can qualify for the position, or in the subject, before which I mark X.

- | | |
|--|--|
| <input type="checkbox"/> ELECTRICAL ENGINEER | <input type="checkbox"/> CHEMICAL ENGINEER |
| <input type="checkbox"/> Electrician | <input type="checkbox"/> SALESMANSHIP |
| <input type="checkbox"/> Electric Wiring | <input type="checkbox"/> ADVERTISING MAN |
| <input type="checkbox"/> Electric Lighting | <input type="checkbox"/> Window Trimmer |
| <input type="checkbox"/> Electric Car Running | <input type="checkbox"/> Show Card Writer |
| <input type="checkbox"/> Heavy Electric Traction | <input type="checkbox"/> Outdoor Sign Painter |
| <input type="checkbox"/> Electrical Draftsman | <input type="checkbox"/> RAIL ROADER |
| <input type="checkbox"/> Electric Machine Designer | <input type="checkbox"/> ILLUSTRATOR |
| <input type="checkbox"/> Telegraph Expert | <input type="checkbox"/> DESIGNER |
| <input type="checkbox"/> Practical Telephony | <input type="checkbox"/> BOOKKEEPER |
| <input type="checkbox"/> MECHANICAL ENGINEER | <input type="checkbox"/> Stenographer and Typist |
| <input type="checkbox"/> Mechanical Draftsman | <input type="checkbox"/> Cert. Pub. Accountant |
| <input type="checkbox"/> Machine Shop Practice | <input type="checkbox"/> Railway Accountant |
| <input type="checkbox"/> Gas Engineer | <input type="checkbox"/> Commercial Law |
| <input type="checkbox"/> CIVIL ENGINEER | <input type="checkbox"/> GOOD ENGLISH |
| <input type="checkbox"/> Surveying and Mapping | <input type="checkbox"/> Common School Subjects |
| <input type="checkbox"/> PIPE FITTERS OR ENGR. | <input type="checkbox"/> CIVIL SERVICE |
| <input type="checkbox"/> Metallurgist or Inspector | <input type="checkbox"/> Railway Mail Clerk |
| <input type="checkbox"/> STATIONARY ENGINEER | <input type="checkbox"/> Textile Dresser or Supt. |
| <input type="checkbox"/> ARCHITECT | <input type="checkbox"/> AGRICULTURE <input type="checkbox"/> Spanish |
| <input type="checkbox"/> Architectural Draftsman | <input type="checkbox"/> Navigator <input type="checkbox"/> German |
| <input type="checkbox"/> PLUMBING AND HEATING | <input type="checkbox"/> Poultry Raising <input type="checkbox"/> French |
| <input type="checkbox"/> Sheet Metal Worker | <input type="checkbox"/> Automobiles <input type="checkbox"/> Italian |

Name _____
 Present Occupation _____
 Street and No. _____
 City _____ State _____



This Man Specialized in ELECTRICAL METER ENGINEERING!

Now he is superintendent of Instruments and meters for a large Electric Light and Power Co. and has 25 men under him! The training he got from our easily mastered, home study course enabled him to step into this big job after only a few months study. What he has done YOU CAN DO!

Write Today for Free Literature with this man's own story of his success. Find out about the exceptional opportunities in this interesting, fascinating, profitable profession. Your name and address is enough. The book is free. No obligations. Write today—NOW You can have a job like this. Fort Wayne Correspondence School, Dept. 7445; Fort Wayne, Ind.

WOULD YOU BE UP-TO-DATE?

This is the Age of Electricity! Read "The Electrical Experimenter" every month.



THE WORLD IS OPEN
to the wireless man. Travel, good positions, rapid promotions, attractive salaries are waiting for our licensed operators. Full course 6 months. Only Radio School in New England. Fine equipment. Officially endorsed by U. S. Government and Marconi Co. Easy payments if desired; day and evening classes.

Send stamp for prospectus

EASTERN RADIO INSTITUTE

899-B Boylston
Street

Boston, Mass.



Learn Wireless Under Marconi's Chief Instructor

SPECIAL EVENING COURSES
for amateurs or beginners now in session. Out-of-town men should write for information about temporary day employment and living conditions while studying. Our students may enter the Marconi service direct.

Radio Operators are now in Great Demand

Great stress is laid on laboratory experiments, with complete commercial apparatus. Special training given on advanced types of Trans-Oceanic Equipment. Course under the personal supervision of the Instructing Engineer of the Marconi Co. Send today for our folder E.

EASTERN DISTRICT Y. M. C. A.

Marcy Ave., near Broadway Brooklyn, N. Y.
13 minutes from New York City Hall. 18 minutes from Hudson Terminals.

383 EXPERIMENTS FOR EVERY STUDENT



That's how we teach you electricity in One Year, by actually training you to handle, use and install electrical instruments and apparatus of every kind and style.

Our equipment is absolutely perfect and includes instruments and machines so expensive you will hesitate to touch them. Yet we require you to use them till you know electricity

thoroughly. Enter at any time.

Our FREE illustrated Book E will give you full details. Send for it to-day.

SCHOOL OF ENGINEERING
of MILWAUKEE

313 Stroh Building MILWAUKEE, WIS.

ELECTRICAL men with training are always in demand. Having trained over 2500 young men in the past 23 years in the fundamentals of Applied Electricity, THE BLISS ELECTRICAL SCHOOL, with its well-equipped shops and laboratories, is peculiarly well qualified to give a condensed course in Electrical

ENGINEERING

Including Mathematics, Steam and Gas Engines, Mechanical Drawing, Shop Work and Theoretical and Practical Electricity, in all branches. Students actually construct dynamos, install wiring and test efficiency of electrical machinery. Course, with diploma, complete

IN ONE YEAR

For practical young men with limited time.
25th year opens Sept. 26th. Catalogue on request.
260 Takoma Avenue, Washington, D. C.

Radio Preparedness

Our Army and Navy are in urgent need of competent Radio Men. Have you thought of offering your services in this capacity?

We have trained hundreds of competent operators. Why not you? Our day or evening courses embracing Electricity of Radio, Code Practice, Radio Engineering, Laboratory Work and Traffic, will prepare you to secure a Gov't First Class Commercial Radio License. Learn under a U. S. Government Inspector.

Modernly equipped Laboratory—Expert Instruction—Lowest Tuition—Dormitories—Employment Bureau.

Send for Catalogue

Y. M. C. A. Radio School
145 E. 86th St. New York, N. Y.

Let the pyramids in Fig. 4 represent the ions in an ionic crystal, the bases representing the molecules and the vertices or points the electrons. The electrons or points being negatively charged, seek what is to be the positive pole of the detector for the rectified current. The molecules being positively charged seek what is going to be the negative pole of the detector. When an alternating current enters the crystal these ions are polarized, somewhat as the molecules of iron in an iron bar are polarized in magnetic hysteresis. This makes the crystals better conductors in one direction than in the other, or in other words they become rectifiers. The impulses passing thru the crystal in the direction of the points (Fig. 4) meet a very low resistance and are allowed to continue. The impulses coming in the opposite direction, or against the points, meet a very high resistance and are converted into heat, being to all practical purposes thus suppressed or *wiped out*. To this class of ionic crystals belong the crystals of silicon, molybdenite, perikon (copper pyrites and zincite), carborundum and titanium dioxide, titanium (Ti_2O_3) occurring in two forms, viz., as the minerals brookite and anatase.

Thus while both the thermo and ionic detectors convert alternating current into direct current, the former work by a thermo e.m.f. in one direction, while the polarized ions of the latter cause these crystals to conduct better in one direction than in the other.

My unique method of ionic tuning depends upon the following discovery, which I have made, viz.: *The ions of each chemical element or compound have a definite rate of vibration, the ionic groups of no two elements or compounds having the same rate of vibration.* Thus each chemical element or compound is sharply distinguished from every other element or compound by its characteristic ionic vibrational rate.

My novel method of ionic tuning is based on this newly discovered principle and I make use of the principle in the following simple manner—namely, by employing the same chemical element or compound in receiving the radio impulses as in generating them. For example, silicon may be employed both in the spark gap at the sending station and in the detector at the receiving station; or, when employing a zincite detector at the receiving station, a zinc spark gap may be used at the sending station, and I have found that not only can excellent selectivity be obtained in this manner, but the detector is far more sensitive to a sender employing the same material, thus permitting transmission over much greater distances.

This phenomenon I believe to be due to the fact that the vibration of the ions in the detector is vastly more easily affected by disturbances of the same basic character produced in the ether by a sender of the same material. On the contrary, when dissimilar elements are used in the sender and receiver respectively, as has heretofore been done universally, the ionic vibration at each end is not in unison but is in dissonance.

In further experimentation along this line I intend more fully to study the effects of combining two or more elements in both the sender and transmitter in order to determine whether or not any material loss of efficiency or other disadvantage results from such combination, and I suggest this as one of the many fruitful fields of research opened for future endeavor by my discoveries herein publicly disclosed for the first time.

It is stated that one result of the war in Germany has been the greatly extended use of aluminum for many purposes. Its use is one of the outstanding features of captured German motor construction, being

used for crank cases, gear boxes and even cylinder heads, jackets and shafts. The Germans are said to be able to produce aluminum very cheaply, largely owing to the mining of coal in occupied French territory by forced labor. The cheap production of electricity has also stimulated the development of electric motor vehicles, which are now being run with nickel-iron batteries, owing to the shortage of lead.

AN ELECTRIC PARADOX OR SELECTIVE LAMP CONTROLLER.

(Continued from page 37)

mechanism. Adjust N so that the travel of the armature shaft is such that every time it travels from the down to the up position, a tooth of the ratchet will have moved the distance between two teeth ($1/12$ revolution).

The three lights to be operated and also the knife switch may be mounted on a suitable lamp board as shown in the photograph. The mechanism just described and also the rheostat may be hidden, and only the wires coming to the lamp board exposed.

It will no doubt afford the reader considerable amusement when he shows the device to some of his friends who think they are *wiring sharks* and that nothing electrical can fool them.

A STUDY OF THE LAW OF RESPONSE OF THE SILICON DETECTOR.

(Continued from page 34)

ponents of the transmitted waves, loops were made with the lengths of the vertical and horizontal portions of the wire in varying ratios. Curves showing extreme variations were obtained. The conclusion to be drawn from these curves is that the horizontal portions of the loop give a maximum response at 0 deg. and 180 deg., the vertical portions at 45 deg. and 135 deg. The receiver responds both to the horizontal and vertical components of the waves received, and the position of the maxima will vary with the particular form.

Receiver in Horizontal Plane.

Since for the study of the law of the detector it was desirable to eliminate as far as possible all response to the vertical component, the entire receiver was placed in the horizontal plane and suspended as before by rubber bands. To reduce still further the response without the resonator the short loop which had given the minimum effect was used. The screen was rotated thru 360 deg. and readings were taken every 20 deg. with and without the resonator as before. The curves obtained showed the effect without the resonator to be a much smaller fraction of the entire response than under the best conditions with the receiver vertical. As a further precaution, oscillator, receiver and rotating screen were carefully centered. Curves obtained under these conditions both with and without the resonator had their maxima at 0 deg. and 180 deg., and their minima at 90 deg. and 270 deg., and the effect without the resonator was extremely small.

The effect for the 90 deg. position of the rotating screen, the position of no transmission, was still to be considered. This residual effect with the resonator was about 15 per cent. of the maximum, and indicated that with the screens used there were diffraction effects which, as might be expected, were more noticeable with the resonator than without. In order to investigate the diffraction the receiver was placed in a tin box. The response to the waves did not entirely cease until the tin cover was made completely to enclose the receiver; even a small opening in the cover produced a decided deflection of the galvanometer. That

the effect was due to the action of diffracted waves on the receiver was further shown by the fact that with the rotating screen in the position to allow no transmission a wire reflector back of the receiver at varying distances clearly indicated the presence of nodes and loops at distances apart which showed the wave-length to be that of the original wave. The average distance from node to node was found to be slightly more than 50 cm., making the wave-length approximately 100 cm.

Final observations were made with the receiver in the horizontal position at a distance of 225 cm. from the first screen, and with the oscillator at distances from the screen ranging from 120 cm. to 230 cm.

The Law of the Silicon Detector

Since for the final curves obtained the receiver was so adjusted as to respond only to the horizontal component of the transmitted wave, it seemed possible to use the data to determine the law of response of the silicon detector with a variation in the intensity of the incident wave. The data already obtained showed the response of the receiver for each position of the rotating screen. Since only the component of the wave at right angles to the wires of the screen could be transmitted, the amplitude of the transmitted wave varied as the cosine of the angle between the wires and the vertical. As the receiver was capable of responding only to horizontal waves, the transmitted component suffered a second resolution at the receiver, which again cut down its amplitude by the cosine of the same angle. Hence the amplitude of the component of the wave to which the receiver responded was proportional to the square of the cosine of the angle between the vertical and the wires of the screen. Presumably the amplitude of the oscillations set up in the receiver for different positions of the screen was proportional to the amplitude of this received component, and hence to the square of the same angle.

In determining the law only those data were considered in which the values of the current obtained without the resonator were small. For each set of readings two curves were plotted, with the galvanometer deflections as abscissae and in one case the second, in the other the fourth powers of the cosines of the angles as ordinates.

From these results it seems safe to conclude that the rectified current is proportional to the fourth power of the cosine of the angle between the vertical and the wires of the rotating screen.

Since the amplitude of the oscillations in the receiver is presumably proportional to the square of the cosine, this result indicates that the rectified current thru the silicon detector is proportional to the square

of the oscillating current in the receiver. Austin, in his study of the silicon detector, reached the conclusion that for alternating currents of ordinary frequencies and for oscillating currents of a frequency of 140,-

000 the rectified currents are approximately proportional to the square of the alternating currents. The results of the investigation of the writers confirm this law for a frequency of approximately 3×10^6 .

Wireless Taught By Mail

You May Learn Theory, Code and Laws of Radio Communication in Our School or at Your Home

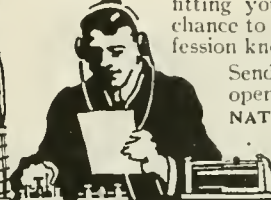

fitting you for positions paying good salaries with wonderful chance to travel the world over. It's the most interesting profession known and the demand for skilled operators is increasing.

Send stamp for catalog giving facts. Resident classes open Oct. 2nd.

NATIONAL RADIO SCHOOL, 14th & U Sts., N. W., Washington, D. C.

WASHINGTON

Offers Special Advantages for These Courses.

S=T=O=P!

We hereby present the greatest bargain ever offered in electrical literature.

A complete volume of the **Electrical Experimenter** bound in rich, dark green linen, stamped with gold letters at the extraordinary low price of

\$1.25

Postage on 7 lbs. is extra

On May 15th Price goes to \$2.00



copies would bring. Mind you, the book is durably bound with heavy covers. You will be proud to have it in your library. We have only 300 copies, therefore be sure and order to-day. Shipping weight 7 lbs. Add a sufficient amount for postage.

Order today to avoid delay

EXPERIMENTER PUBLISHING COMPANY, Inc.

Book Department, 233 Fulton Street, New York, N. Y.

FOX TYPEWRITERS



Factory Rebuilt, Like New, at \$52.50

The word "rebuilt" has been abused and misused until it has become a meaningless trade term. When we rebuild a Fox Typewriter we take it all to pieces, re-nickel the nickel parts, re-enamele the frame and replace all worn parts with new ones. The same men who originally built the typewriter do this rebuilding and do the work just as good.

40% New Parts and Three Years' Guarantee

We offer a rebuilt Fox Typewriter, Model No. 24—just like new—for \$52.50. These have standard carriages, taking paper 10½ inches wide, any kind of keyboard, any kind of type, rubber covers, tabulators, back spacers, two-color ribbons, complete with instruction books and cleaning outfits, and are guaranteed for 3 years, the same as new ones, and to have not less than 40% of new parts.

Send any amount you can spare, from \$1 up, as a first payment, and pay the balance \$5.00 monthly. 5% discount for all cash. Purchaser must pay transportation. If \$10.00 or more is sent with order we will include FREE a Fox Solid Oak Typewriter Table selling at \$1.50. Please order direct from this offer and inclose any amount you can spare—and be sure and mention The Electrical Experimenter for March.

FOX TYPEWRITER CO., 8702-8752 FRONT AVE., GRAND RAPIDS, MICHIGAN

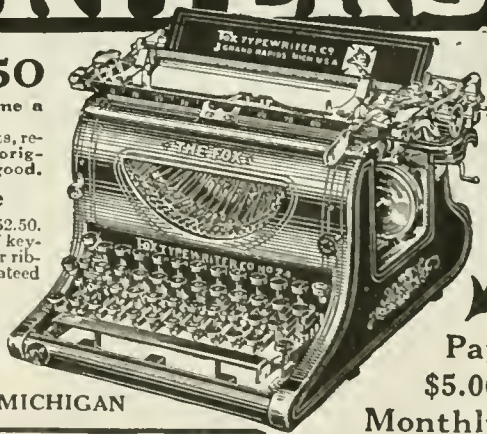

Pay \$5.00 Monthly

STRONGER WIRELESS COMMUNICATION.

Another record-breaking achievement in the wireless art has been accomplished by the Marconi system in establishing strong, direct and continuous communications over twelve-hour periods between the station of the Marconi Wireless Telegraph Company of

America at Chatham, Mass., and that of the English Marconi Company at Carnarvon, Wales. The signals received at Chatham from Carnarvon were from three to eight times as strong as those obtained from any other European station. These tests were successfully carried out on January twenty-ninth and thirtieth.

A SIMPLE ELECTRIC MOTOR ATTACHMENT FOR PHONOGRAPHS.

(Continued from page 40)

other two holes mentioned are intended to take the bolts that run through the motor. These bolts are lengthened, by the addition to their ends of 1/2 inch binding posts, as shown in Fig. 1, upper end of the motor, or are replaced by new bolts long enough to extend through the top board, so as to support the motor. In the writer's case it was a simple matter to find two short binding posts which would screw on to the ends of the motor bolts. With these in place the motor shaft was inserted through the center hole, the binding post slipping into the other two holes, and the thumb bolts which fit the top threads of the binding posts, were fitted with soft rubber washers, inserted in place and screwed up tight to hold the motor in place. The rubber washers mentioned above deaden the hum of the motor considerably, but if their effect is not great enough two thin washers, made from banner felt, can be inserted between the motor top and the talking machine top, being held in place by the motor bolts and bearing as shown in Fig. 1 at b.

The belt should be crossed in order to drive the turntable properly; the electric motor having its field winding terminals reversed if it rotates in the wrong direction.

A simple white string belt, about 1/20 of an inch in diameter, has been used for about two months with excellent results by the author, although at first several materials were tried experimentally, such as leather, rubber, tape and laces. Besides being the simplest to obtain and make up the string belt gave the best service, and is still in use, although the diameter is reduced about 30% by wear. The ends of the belt were simply joined by being tied in an ordinary knot. This belt is readily renewed.

When the driving mechanism has been completely assembled one end of a flexible lamp cord can be attached direct to the motor wires, after first being passed through the hole which formerly contained the crank handle, for winding the motor. The lamp cord may be connected to a lamp socket and the motor controlled by the key switch in the socket, or if so desired a simple push button switch can be connected to the cord near the machine, or else set into the body of the machine itself. The regular stop, with which the phonograph was originally fitted, should be kept in release by means of a small tack or phonograph needle driven into the machine top to hold the lever at starting position.

The records can be readily changed without stopping the machine, provided the turntable is not held back too much by clumsy manipulation of the records. This practice, however, is not to be especially recommended, and is not at all necessary, as the machine with an electric motor attachment attains full speed very quickly upon starting. The speed can of course be regulated in the manner already advised, by the ordinary speed lever.

FIRE SALE!! OF SLIGHTLY DAMAGED BOOKS

A fire in our stock rooms caused many books to be damaged by smoke and water. Every one is good except for covers and contains just as much valuable information as when it was new. But we can't sell them for new. Rather than dispose of them to dealers, we prefer to give our readers the benefit. What we offer you is a combination of

Our Celebrated Wireless Course (160 p. 400 illus. flexible cloth) Reg. Price \$1.00.

List of Radio Stations of the World (Call letters and location of every station in the world) stiff cloth, Reg. Price \$.50.

The Experimental Electricity Course (160 p. 350 illus. stiff cloth) Reg. Price \$1.00.

How to Make Wireless Sending Instruments (100 p. paper) Reg. Price \$.25.



ALL FOR \$1.50 PREPAID

Remember the books are damaged but in many cases only the bindings have a few water spots. But every book is absolutely complete.

This is the biggest bargain in books we have ever offered. You should take advantage of it at once. Send to-day. Remit by cash, postal or express money order to

THE EXPERIMENTER PUBLISHING CO., Inc., 233 FULTON STREET NEW YORK CITY, N. Y.

ACCEPT THIS BOOK FREE IT'S INVALUABLE YET CAN'T BE BOUGHT

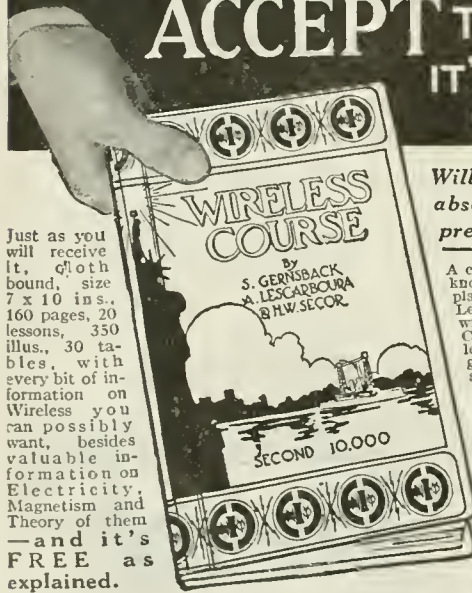

Just as you will receive it, cloth bound, size 7 x 10 ins., 160 pages, 20 lessons, 350 illus., 30 tables, with every bit of information on Wireless you can possibly want, besides valuable information on Electricity, Magnetism and Theory of them — and it's FREE as explained.

Will you take a 20 lesson Wireless Course absolutely FREE—even postage charges prepaid?

A course that tells you everything you can possibly want to know about "Wireless" starting off in lesson No. 1 by explaining the Principles of Electricity. The Second and Third Lessons are devoted to magnetism, motors, generators and wiring. And then, by simple, easy stages this wonderful Course takes you into "Wireless." The mysteries of "Wireless" are unfolded to you by the use of such simple language so skillfully used, that of necessity you must understand every word. The subjects are not treated superficially, however, for there is a whole lesson devoted to the Theory and Mathematics of this epoch-making subject. To lend charm to the Course, the last Lesson (No. 20) is devoted to a history of Wireless and the men who developed it. The wireless course positively cannot be bought, but will be sent absolutely free with a full year's subscription (12 numbers) to the Electrical Experimenter at \$1.50. It's the biggest money's worth you can ever buy anywhere at any time. Send for it today enclosing \$1.50. Send now before you forget.

The coupon below is a convenient way. But do it now.

THE EXPERIMENTER PUB. CO., Inc.
 Publisher
 "The Electrical Experimenter Magazine."

EXPERIMENTER PUB. CO., 233 Fulton St., New York

Gentlemen:

On your absolute guarantee that your 20 Lesson Wireless Course is just as described by you, you may send me same FREE. You are to send me this Course at once, all charges paid, and enter my name for a full year's subscription to the *Electrical Experimenter*, 12 numbers, for which I enclose *\$1.50, the price of the *Electrical Experimenter* alone.

(If a 2-year subscription is desired, enclose \$2.85.)

My name is.....

My address is.....

(5-17)

*Canada and Foreign Countries, \$2.00—2 years, \$3.85.

WIRELESS TELEGRAPHY.

(Continued from page 27)

Azores, to the western shores of Europe, to Madeira, Cape Verde, the mouth of the Amazon, Panama, the Galapagos Islands off the western coast of Ecuador, and Magdalena Bay. The radius also embraces thru the chain San Francisco and the whole stretch of the California, Washington and Oregon coasts, the lonely wastes of Upper Canada, Hudson's Bay and the southern nose of Greenland, the entire Caribbean

(Continued on page 78)

Free to You!

Read this Remarkable Offer!

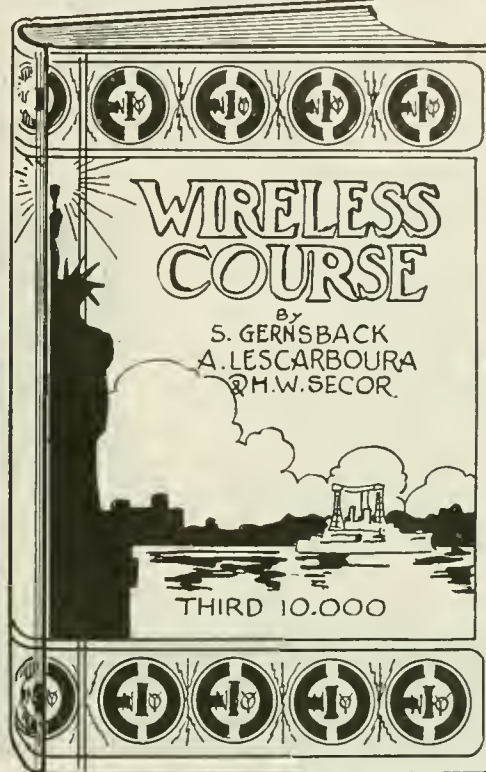
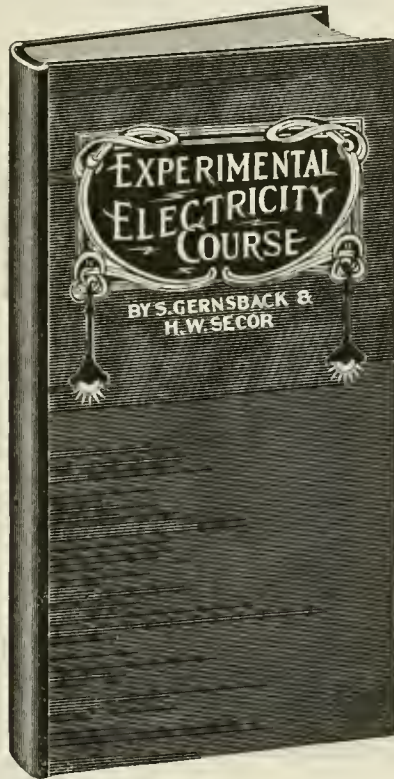

This masterpiece contains 160 pages, 400 illustrations. Size of book 5" x 9". Printed on extra thin paper, so book can be slipped in pocket. Handsome stiff cloth cover. Price \$1.00 if bought alone. FREE with a year's subscription.

The most comprehensive Wireless Course ever printed. Contains 160 pages, 350 illustrations. Size of book 6 1/2" x 9". Very fine flexible linen cover. Price \$1.00 if bought alone. FREE with a year's subscription.



12 copies of THE ELECTRICAL EXPERIMENTER make a book 9" x 12" and 4" thick. This book will weigh 7 lbs. It is the greatest Electrical and Wireless reference work in the world. And all for \$1.50

This is a very limited offer. It may be withdrawn at any time, due to the tremendous cost of paper, which IS JUST DOUBLE WHAT IT WAS ONE YEAR AGO. We only have about 2000 each of these fine books on hand; after they are gone we cannot reprint the books until conditions become normal again. THIS MAY BE TWO YEARS OR MORE. Now is your chance.

The publishers of this journal have earned an enviable reputation of giving more than 100 cents' worth for each dollar spent with them. Profit by this liberal opportunity NOW; it may never be made again.

HERE'S THE OFFER

Subscribe to THE ELECTRICAL EXPERIMENTER for one year, at the regular subscription price of \$1.50 per year (Canada and foreign \$2.00) and we will send you FREE POSTPAID, either one of the above books. If you subscribe for two years, BOTH BOOKS WILL BE GIVEN FREE, POSTPAID.

If you are a subscriber at present, take advantage of this wonderful opportunity anyway. If you do, we will extend your present subscription for one year.

This Offer Limited. Act Now

EXPERIMENTER PUB. CO.,
233 FULTON STREET,
NEW YORK CITY

FILL IN - TEAR OUT - AND MAIL

5-17

Gentlemen:
Please enter my subscription to THE ELECTRICAL EXPERIMENTER for the term of year, for which I enclose herewith \$
You will also send me at once FREE prepaid your book

Name
Address

Sea, all of the West Indies, most of Peru, all of Colombia, Venezuela, the three Guianas and the watershed of the Amazon; and all of the United States, Mexico and the Central American Republics are within the range of these stations. Weather reports and time signals and also information in regard to ice, obstructions to navigation, etc., are sent out broadcast for the information of navigators.

oceanic communication was a startling achievement. Regular message traffic has been transmitted between Europe and America continually for more than eight years over a duplex wireless circuit between Clifden and Glace Bay; that is to say, messages between these points are transmitted in either direction simultaneously. The transmitting and receiving apparatus of a station are not placed close together, but several miles apart.

EXPERIMENTAL CHEMISTRY.

(Continued from page 52)

base, the metal of the base enters into the acid in place of the hydrogen and the hydrogen combines with the hydrogen and oxygen of the base to form water.

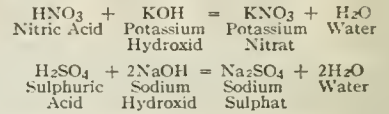

NOMENCLATURE OF SALTS—

The name of the salts containing oxygen are derived from the name of the corresponding acid. The characteristic suffix of the acid is changed to indicate this relation. Thus, the suffix *ic* becomes *ate*, and the suffix *-ous*, becomes *-ite*. [Note: The final "e" is usually dropt in simplified spelling as used in this journal.]

- Sulfuric acid form Sulfats
- Sulfurous acid form Sulfites
- Nitric acid form Nitrats
- Nitrous acid form Nitrits
- Chloric acid form Chlorats
- Hypochlorous acid form Hypochlorits
- Permanganic acid form Permanganats

The name of the replacing metal is retained, as, Potassium chlorat, sodium sulphat, calcium hypochlorit, potassium permanganat. Notice that the prefixes *Hypo-* and *Per-* are not changed.

The names of salts containing only two elements, following the general rule for binary compounds, end in *ide*. This suffix is added to a modification of the name of the non-metal, giving the names chlorid, bromid, sulphid, fluorid, etc. The prefix *Hydro-* which is contained in the name of the acid is omitted. Thus, the name of the sodium salt of hydrochloric acid is sodium chlorid; similarly, there are the names potassium chlorid, calcium fluorid, and sodium iodid. Sometimes, the salts of these hydrogen acids are called Halids, to emphasize their relation to common salt, which in Greek is called Hals.



VIOLET-RAYS!

NEW LIFE, POWER, HEALTH and BEAUTY in the marvelous delightful VIOLET-RAYS. Newest and most powerful form of electricity, causing neither muscular contraction nor pain of any kind.

THE VIOLETTA

High frequency instrument is endorsed by thousands of Physicians who use it daily.

Produces SOOTHING, INVIGORATING, CURATIVE VIOLET-RAYS. Wonderfully quick results obtained in treating SCALP, FACE and BODY. Health bringing OZONE forced into the blood, producing an abundance of VITALITY.

Sent on Free Trial

Simple in construction and operation. The VIOLETTA is especially adapted for personal use in the home. Will operate on alternating or direct current or battery. ABSOLUTELY SAFE and GUARANTEED.



Write for New Free Book

Send for our new beautifully illustrated book on VIOLETTA. Tells all about the marvels of Violet-Rays. Read what scientists and doctors have to say. Post card brings book and all particulars of special low price and free trial offer.

Dealers write **BLEADON-DUNN CO.** Dept. 1A
208 NORTH FIFTH AVENUE, CHICAGO



ACCEPT THESE BOOKS FREE

Since we published these two books last year, over 16,000 of each have been sold. If you are a wireless experimenter, you can ill afford to be without these two latest authoritative works, published by the one concern in America, that knows what the "How-to-make-it Fiend" really wants. In these two hand books are concentrated the most important, up-to-date wireless instruments and directions how to make them. They are by far the most successful wireless books of the season. Size of each book is 5x7 inches, substantially bound on a good book paper. The covers are in two colors. We really can not praise these works too highly. You will be delighted with them.

A CLEAR TRACK TO SUCCESS

FOR THE TRAFFIC INSPECTOR

Learn this new profession in 3 to 4 months with our complete course. Prepare for big pay—promotion—success. Railroads everywhere are watching for good traffic inspectors. The training obtained in this work leads to sure opportunities for advancement.

Get ready for the success that awaits you. Earn big pay with short hours. Travel at no expense. Our Employment Bureau helps successful graduates obtain positions. Write now for booklet G-12, giving full information.

FRONTIER PREP. SCHOOL - Buffalo, N. Y.



SPARK COILS For Wireless

STYLE C SPECIAL 1" COIL \$3.50
Postage extra

FINE RESULTS WITH THIS COIL

SCHUG ELECTRIC MFG. CO.
254 EAST LARNED, DETROIT, MICH.

EXPERIMENTER PUB. CO., 233 Fulton St., New York

Gentlemen:

On your absolute guarantee that your two big Wireless Handbooks are just as described by you, you may send me same **FREE**. All charges prepaid. You are to send me these books at once, and enter my name for a full year's subscription to the *Electrical Experimenter*, 12 numbers, for which I enclose \$1.50, the price of the *Electrical Experimenter* alone.

(If a 2-year subscription is desired, enclose \$2.85.)

My name is.....

My address is.....

(5-17) *Canada and Foreign Countries, \$2.00—2 years, \$3.85.

Scientific Exchange Columns

UNDOUBTEDLY you have at the present time some things for which you have no further use. Do you wish to exchange them for something, for which you have immediate use? There is no surer and quicker way to do this than by advertising your articles in these columns. The *Very* people, the *Only* people, who could possibly have a use for your things read this journal. More than 75,000 interested people will see your ad. It is furthermore the cheapest advertising medium for you in the country. Dealers' advertising accepted in Opportunity Exchange Columns only.

The rates are: *Three cents per word* (name and address to be counted), minimum space 3 lines. Count about 7 words to the line. Remittance must accompany all orders. No advertisement for less than 50c. accepted.

We reserve to ourselves the right to refuse any advertisement which we consider misleading or objectionable. Advertisements for the June issue should reach us not later than April 25.

The Classified Columns of "The Electrical Experimenter" Bring Positive Results.

Subscribers experiencing trouble in dealing with any advertiser should notify the publisher very promptly.

OVER 75,000 PEOPLE READ THIS JOURNAL

FOR SALE—As am not permitted to erect aerial will sell my new cabinet receiving set. Contains large loose coupler, primary and secondary loads, variable and fixed variable condensers, detector, potentiometer, buzzer test anchor gap. All instruments enclosed, with switch and lever control. With Brandes headset \$50. Send 5c. stamp for photo. Also spiral helix \$2. Spark Coil \$1.50, tuner 14 inches long \$1. Switches, detector parts, several lbs. fine wire and wireless books. Wanted, for cash, catboat or rifle. Len K. Wright, 518 East 83d St., N.Y. City.

FOR SALE—1/4 K.W. Closed-core Transformer, \$8.50. Also 200 W. Step-Down Transformer with 6, 12, 18, 24 V. taps, \$3. Both in first-class condition. F. K. Billau, 525 N. Delaware, Indianapolis, Ind.

FOR SALE—International Correspondence Schools' course in arithmetic. Also wireless apparatus, cheap. Alex. Serna, Lehigh, Okla.

ATTENTION—Sale or Exchange: Motor, \$20; lathe, \$35; generator, \$6; motor, \$6. Stamp for descriptions. H. E. Neefe, La Farge, Wis.

EXCHANGE—Five volume set of Automobile Cyclopaedia, red cloth bound, gold stamped, also six volume set of Modern Shop Practice, flexible leather binding (published by American Technical Society), current editions, for receiving or sending apparatus of standard make. Charles B. Hayward, Great Neck Sta., New York.

IF ANY ONE can give me the address of W. B. Dougherty it will be thankfully received. Chas. Dougherty, Louisiana, Mo.

WANTED—Coil rated at 2 inches. Will pay cash. Henry Kienzle, 501 East 84th St., New York.

FOR SALE OR EXCHANGE—15,000 M. Loose Coupler, \$10, also small Loose Coupler, \$4, or will exchange for Variometer or Audion. Wanted to buy good polarized relay. Write to J. Cingature, #66 Thirteenth Ave., Milwaukee, Wis.

FOR SALE—\$5, 22 revolver shot six times, \$3; loading coil, \$1; automatic telephone, \$3; \$6.50 moving picture machine, \$4. William D. Peteet, Greenwood, Miss.

EXCHANGE—Good mandolin with case, for typewriter. Write if interested. Wm. Bolme, Enloe, N.Dak.

SALE—Telegraph Instruments, Motors, etc. See ad in April EXPERIMENTER. Sydney Young, Jr., Addison, N.Y., R.F.D. No. 4.

FOR SALE—Three-inch coil, \$9; relay, \$3; medical coil outfit with meter, cost \$100, sell for \$16. Ford electric starter and generator, \$20 Gorham Cottrell, 1628 Jersey, Quincy, Ill.

FOR SALE OR EXCHANGE—Railroad motor car for electrical goods. S. R. Kimball, Diamond Bluff, Wis.

BARGAIN—Rotary gap having Klitzen disc and 110-volt Universal motor, \$6. Fred Ancona, 16th St., & Mineral Spring Road, Reading, Pa.

FOR SALE—1,500 meter tuning coil; 1,000 meter tuning coil; detector, 60c. All new, make offer. Francis H. Coleman, 27 Salem St., Springfield, Mass.

4-Step Packard Transformer in paraffine wax and oak case, E. I. Government phones, 5 lbs. No. 22 D.S.C. wire. Cheap. Best offer takes them. F. Allen, Bliss, Takoma, D.C.

FOR SALE—Two brand new DeForest amplifiers with burned out bulbs. Price right. Palmer Southworth, 34 Montowese Street, Hartford, Conn.

FOR SALE—200 watt transformer. Steps 110 to 10, 20, 30 or 40 volts, \$10; 40 watt dynamo or 1/12 H.P. motor, \$7; Inch spark coil; fine fat spark, \$4; Testing magneto, \$2.50; 20 ohm sensitive pony relay, \$1.50; 20 ohm giant sounder and steel key, \$2.50; Portable voltmeter, 1-20 range, \$1.50; Filings coherer, \$1; 75 ohm wireless receiver with headband, \$1.25; 1/12 H.P. water motor, \$1.50. C. M. Adams, Milford, Ohio.

SELL—40 lesson Taxidermy Course, \$9. Trade 3 yrs. Youth's Companions for A1, 2 slide tuner. William Litwiller, Hopedale, Ill.

FOR SALE—110 volt, 1/2 ampere dynamo (\$12) used very little. J. T. Greene, Carrs, Ga.

FOR SALE—Hytone Clapp-Eastham 1/2 kilowatt transformer in original case. No helix, gap, or condenser. Bargain, \$15. Perfect condition. Also new rotary gap. Never used. Adams Morgan make, Robbins & Myers 110 V direct current motor speed 3,000. This gap will be just the thing for the Hytone transformer, \$8. Both for \$21. All letters answered. Ralph B. Austrian, 49 St. Nicholas Terrace, New York City.

EXCHANGE—"Remy" magneto with vibrator and 1 inch coil without vibrator for 3,000 ohm Phones or what have you? Walter Heinrich, 15 Colby St., Lawrence, Mass.

FOR SALE—Extremely sensitive Audio-Tron bulb, \$4. Send for list of wireless goods. What have you for sale? Henry Lehmborg, 5116 N. 12th St., Philadelphia.

WANTED—Burnt out De Forest Audion Bulbs. Will pay cash or exchange wireless goods. Joe Singer, Goldfield, Nevada.

FOR SALE—Tigerman Detecto-Amplifier Type C, panel type with two bulbs, \$16. Eddie Smith, 688 South 39th St., Louisville, Ky.

FOR SALE—Thor motorcycle, good running order, has up-to-date equipment. Bargain at \$35. Also Thor motorcycle complete except for engine at \$10. Harvey Adams, Chambersburg, Ill.

WANTED—R.J. 9 Audion and storage battery, 43 plate variable and E.I. or Murdock loader. L. H. Hammond, Box 51, Baden, N.C.

TALK ABOUT RESULTS!

17 PRYER LANE,
Larchmont Manor, N.Y.

The Experimenter Pub. Co.,
New York City

Dear Sir:—

Talk about results! You've got to give it to the "E. E." to reach the right people. On the day after "E. E." came out I received a reply and they have been coming in at the rate of one a day. If I ever have anything else that I want to sell I will send my "ad" to you every time.

Yours truly,

Clarence de Witt Rogers, Jr.

NEW \$18. Multi-Audi-Fone, \$12. Mesco, \$12. Intensifying Coil, \$7.50. \$15 Army binoculars in leather case, \$9. All perfect. Peter Pinkston, Valdosta, Ga.

FOR SALE—Pocket Wireless Set 3,000 meters, \$2.75; Redhead single head set, \$1.85. Max Vineski, Troy, Pa.

EXCHANGE for \$16—One Smith Premier No. 4 typewriter, excellent condition, used only short time. Fred Fries, 60 E. Bringham St., Germantown, Philadelphia, Pa.

FOR SALE OR EXCHANGE—134 H.P. Gasoline Engine nearly new, \$20. Wanted, 1/2 H.P. Gasoline engine. Must be in good condition. Glenn Johnson, Missouri Valley, Iowa.

TO EXCHANGE—Chemical laboratory, value \$15 for wireless instruments. J. Y. Parsons, 1906 Park St., Kansas City, Mo.

FOR SALE—Cash only, almost new, half K.W. Blitzen transformer mounted in mahogany, worth \$24 at \$15. Also R.J. 9 Audion new bulb, \$12. New Audio-Tron Panel, two filament, \$9.50. Also one K.W. transformer, new, at a bargain. All these instruments good as new. Holtzer-Cahot phones, new, \$7. Don D. Tullis, 59 N. Second St., Newark, Ohio.

FOR SALE—10 vols. Hawkins' Electrical Guides and one vol. Rogers' Mechanical Drawing. Cost \$12, sell for \$7.50. M. Jacobson, Parkville, N.Y.

FOR SALE OR EXCHANGE—Crookes Spintharoscope, \$8; Thomson A.C. voltmeter, 0-175, \$4, A.C. Ammeter, 0-100, \$4. Tuning cabinet hard rubber panel, variometer coupling, no variables, neat, compact and efficient, \$12. Home-made transformer coil, about 300 watts, \$4. Wanted, small lathe, oscilaudion, variables, books or tools. Experimenter, 2808 N. Lawrence St., Philadelphia, Pa.

WANT TO EXCHANGE lenses, camera and electrical measuring instrument, etc., for old coin and stamps. James Christie, 107 Vanderbilt Ave., Brooklyn, N.Y.

FOR SALE—Tubular Sending Condenser; potentiometer; water motor; large tuning coil; box of wire; screws, etc.; one ten plate sliding condenser, etc. All for \$5, as I have no more use for same. Write or call evenings, Henry A. Gilman, 156 Jerome St., Brooklyn, N.Y.

FOR SALE OR EXCHANGE—Brandes Navy Phones, \$9.25; regenerative coupler, \$6; Clapp-Eastham .002mf variable, \$5.75; Murdock 43 plate variable, \$3.10; Murdock wave meter, \$5; Dunnell key, 75c.; Standard gap, \$1; Murdock rotary gap in sound proof mahogany case—cost \$20 and is brand new, \$11.50; 5 K.W. Aerial switch, \$5; Amplifying coil, \$5; 5 K.W. Oscillation transformer, \$10; 2 sections Murdock Moulded Condenser, \$3; 600 feet No. 12 copper aerial wire, \$4.75; 8 Ball Insulators, \$1; two 10 1/2 inch insulators, 75c.; Lighting switch, \$1.25; two 15 foot poles, \$5; two spreaders, \$2; Winchester model 1906 repeating .22, \$8; Surgeon's dissecting instruments, \$7.50; L. C. Smith typewriter, cost \$97.50, \$45. H. W. Semmelmeier, 2629 N. Fairfield Ave., Chicago, Ill.

SACRIFICE—Smith motor wheel, \$35. Particulars on request. Best condition. Francis Pray, 102 Heath St., Winter Hill, Mass.

WILL EXCHANGE a Keystone milli-ampere meter excellent for radio measurements, a Government type Perikon detector, finely finished. Want small 110 volt A.C. motor, rotary variable condenser, A.C. voltmeter or ammeter, or what have you? Samuel Coben, 1936 Pitkin Ave., Brooklyn, N.Y.

POWERFUL Waite-Bartlett Static Machine. 8 rotary, 8 stationary plates. Gives heavy 16-inch condenser charge. Excellent for X-rays and experiment; perfect condition and best workmanship; complete. Cost over \$300. \$75 or best offer in wireless. Photos and details upon request. T. Earl, Niles, Mich.

FOR SALE—Mandolin, good as new, cost \$15. Will sell for \$10 cash. Instruction books, music rack, case included. Joseph Dushak, Post Office Box No. 114, Owatonna, Minn.

INDIAN TWIN just overhauled, \$70; or trade for marine engine, 6-15 H.P. H. Griffin, Hartsville, Ala.

HAVE—Oliver Typewriter, Model 3. Want cash or receiving apparatus. Make offer. All letters answered. Herbert Richter, Collegeville, Minn.

BARGAIN—Complete new Blitzen Receiving set with extra equipment. Holtzer-Cahot Phones. In perfect condition. Write for particulars. Chas. Bayliss, 68 Peterboro St., Detroit, Mich.

FOR SALE—Complete Audio-Tron on panel with all controls and 4-40 storage battery. Panel has 2 D.P.D.T. mineral change-over switches wired on. Used 10 hours. \$10. Also "Arlington" 4,000 M. Coupler, cost \$9, for \$6.60 and \$4. Murdock Oscillation for \$3. George R. Hammond, Oelwein, Iowa.

WILL EXCHANGE my Twin-Cylinder, 6 H.P. Merkle motorcycle, in perfect condition, for good wireless apparatus. Francis Joannini, 3326 17th St., Washington, D.C.

FOR SALE—Set Cyclopaedia of Applied Electricity. Send for description. All letters answered. J. N. Boyington, South Galena Ave., Freeport, Ill.

FOR SALE—Steam engine designed for commercial use. Bore seven-eighths, stroke 2 inches; and Hoyt voltmeter, both cheap; \$6 cash. A bargain. John N. Lint, Box 171, Meyersdale, Pa.

FOR SALE—Almost new 1/2 K.W. Blitzen unmounted transformer, record of this transformer is 300 miles. 10 volumes "Hawkins Electrical Guides" good as new. Write, Hansford Pennington, 1505 Wyoming St., San Antonio, Texas.

QUICK—Type S S Motor, \$4; 2 slide tuner, loading coil, condenser, 2 detectors, \$6. All new, perfect condition. Send stamp or list. All answered. Chester Shurr, Berthold, N.D.

FOR SALE OR EXCHANGE—One 15,000 meter coupler, one receiving set, one 4 1/2 H.P. gasoline engine. Wanted Omnigraph or what have you? F. B. Dadisman, Independence, W.Va.

FOR SALE—One Electro Selenium Cell, \$3.50. Two-inch Bulldog Spark coil, \$4.50. Gernsback Interrupter, \$1.75. Electro vario-selective coupler, \$4.50. Electro Amateur phones 2,000 ohms, \$3. Electro rotary variable condenser, \$1.75. Electro fixt variable condenser, 75c. Crystaloi Detector, \$2.25. Two Electro high voltage condensers, \$1. Knapp Type S S Dynamo Motor, \$3. Stromberg Transmitters, new, 75c. Telephone Induction Coils, 50c. New receiver cords, 3 ft., 15c., 6 ft., 25c. All these articles are new and guaranteed. Prepaid. Will trade for Smith Premier Type-writer No. 2. F. A. Steinbrook, Brookville, Pa.

TRADE—1/4 h.p. 133 or 125 cycle A.C. Motor for Audion, Audiotron, or Transmitting Apparatus. H. C. Ross, 1087 Schiller St., Columbus, Ohio.

BARGAINS—Crocker-Wheeler 8 V. 1600 R.P.M. motor, \$2. Rebuilt 6 V. Storage Battery, \$6. Inch Spark Coil, \$2.50. Many other bargains. Write for specifications. H. R. Huth, Beaver Dam, Wis.

WANTED—Two kerosene or gasoline engines, one horse-power, second-hand, good order. Branchand Bros., Rutland, Vt.

1/2 H.P. GASOLINE ENGINE, 2000 ohm Red Head Phones (new), 500 ft. Aerial Wire, Coils of Variometers, Loose Couplers, etc., Detectors, Condensers, 4 lbs. Wire, Binding Posts, Switches, Knobs, Buzzers, Miniature Lights, Sockets, Pump Gun, etc. First money order for \$15 takes all. E. Myers, 499 So. 21st St., Irvington, N.J.

EXCHANGE—New Telephone goods, large Meccano, gun. Want wireless goods, banjo or revolver. Towns, Marlboro St., Keene, N.H.

Opportunity Exchange

YOU will probably find more opportunities and real bargains in these columns than anywhere else in the country. Most good things in life are hard to find and worth going after—these little ads illustrate that point; you alone will be the real loser if you don't take the time to scan through these columns.

Advertisements in this section 4c. a word for each insertion. Count 7 words per line. Name and address must be included at the above rate. Cash should accompany all classified advertisements unless placed by an accredited advertising agency.

Ten per cent. discount for 6 issues, 20 per cent. discount for 12 issues from above rate. Objectionable or misleading advertisements not accepted.

Advertisements for the June issue should reach us not later than April 25.

OVER 75,000 PEOPLE READ THIS JOURNAL

EXPERIMENTER PUBLISHING CO., INC., 233 Fulton Street, New York, N.Y.

BOOKS

TO GET BETTER PICTURES: Read the Amateur Photographer's Weekly; illustrated; weekly prize competitions; print criticisms; many unique features; \$1.50 per year; three months' trial subscription 25c.; Abel Publishing Company, 401 Caxton Bldg., Cleveland, Ohio.

HUNTING AND FISHING GUIDE—Most complete work on the subject printed. Handy volume for all sportsmen. Postpaid for only 25c. Iona Press, Box 103, Oak Park, Ill.

STUDY SALESMANSHIP AT HOME—Expert course. Copyrighted, 15 lessons complete. \$1. Central Company, 599 Ninth Ave., New York.

DO YOU WANT back numbers of THE ELECTRICAL EXPERIMENTER? Send for bound volume No. 3, containing issues from May, 1915, to April, 1916. Price \$1.25. Postage on 7 lbs. is extra. Experimenter Pub. Co., 233 Fulton St., New York City.

BOOKS—Scientific and wireless supplied. Let us know what you want and we will quote you. Experimenter Pub. Co., 233 Fulton St., New York City.

A BINDER for THE ELECTRICAL EXPERIMENTER will preserve your copies for all time. Price 50c. Postage on 3 lbs. is extra. Send for one to-day. Experimenter Pub. Co., 233 Fulton St., New York City.

HELP WANTED

MEN AND WOMEN, 18 or over, WANTED for U.S. Government Life Jobs. \$75 to \$150 month. Steady work. Short hours. Rapid advancement. Common education sufficient. Write immediately for free list of positions now easily obtainable. Franklin Institute, Dep't B 27, Rochester, N.Y.

MISCELLANEOUS

ELECTRICIANS—Send 50c. for 10 Blue Prints of Motor and Generator Connections, 28 for \$1, 10 A.C., 4 D.C. Motor Winding Diagrams for \$1 or 20 A.C., 4 D.C. and 4 Rotary Converter Drawings, \$1.60. Winding made easy. Martin Electric Co., 329 Irvington Pl., Denver, Colo.

COLLECT AND SELL names and addresses in your spare time. Big income. No canvassing. Detailed instructions, 10c. (coin). National Exchange, 1314 Park Ave., New York.

EVERYBODY WANTS IT—Folding pocket Coat and Hat Holder. Can attach anywhere and remove instantly, nickel-plated. Sample 10c. Big seller for agents. Wedge Mfg. Co., "Km" Binghamton, N.Y.

STAMPS—75, all different, free. Postage 2c. Mention paper. Quaker Stamp Co., Toledo, Ohio.

250 Letterheads, Envelopes or Radiogram blanks, \$1.50, prepaid. Record, Media, Ill.

DO YOU WANT to buy, sell or exchange? Send 5c. for the Busy-Bee Exchange, also list of things you have to sell or exchange. Busy-Bee, 174 Plymouth St., New Haven, Conn.

AGENTS—500% profit putting initials on automobiles. Particulars sent free. Address, Auto Monogram Co., 2025 E. Monmouth St., Philadelphia, Pa.

PHONOGRAPHS

BUILD YOUR OWN PHONOGRAPH or manufacture them for profit. Drawings, instructions,

etc., 25c. Satisfaction guaranteed. Circular free. Associated Phonograph Co., Dept. E. Cincinnati.

PATENT ATTORNEYS

IDEAS WANTED—Manufacturers are writing for patents procured through me. Four books with list of hundreds of inventions wanted sent free. I help you market your invention. Advice Free. R. B. Owen, 130 Owen Bldg., Washington, D.C.

PATENTS—R. Morgan Elliott & Co., Patent Attorneys, Mechanical, Electrical and Chemical experts, 716-724 Woodward Bldg., Washington, D.C.

PATENTS—Without advance attorney's fees. Not due until patent allowed. Send sketch for free report. Books free. Frank Fuller, Washington, D.C.

PATENTS ON EASY PAYMENTS. Send model or sketch for Free Search and Certified Registration of Your Invention for your Protection. Free Book tells what to Invent and How to Obtain a Patent on Easy Payments. C. C. Hines & Co., 593 Loan & Trust Bldg., Washington, D.C.

PHOTOGRAPHY

AMATEUR PHOTOGRAPHERS—Send for our catalog on photo supplies. We retail to you at wholesale prices. Films developed, 8c. Cortland Merchandise Co., Dept. E., 1851 N. Kildare Ave., Chicago, Ill.

MARCONI—We have a limited number of pictures of Guglielmo Marconi, Nikola Tesla, and Dr. Lee DeForest that are done in sepia on fine India paper. Fine for decorating your wireless room. 10c. each postpaid. Experimenter Publishing Co., 233 Fulton St., New York City.

WIRELESS

ELECTRIC MOTORS at unusual low prices. 1/6 H.P., \$6; 1/8 H.P., \$5; 1/16 H.P., \$4. Other prices on application. A. J. Temps, 1690 Grove St., Brooklyn, N.Y.

FOR SALE OR EXCHANGE—Tungsten steel magnets, lifts 30 lbs., \$1; Telephone magnets, 75c.; Automobile Transformers, \$2.50; 6 volt Starter-motor, \$15; generators, \$15 and \$8; Small motor-generator, \$1; Battery charging outfit for Fords, \$6.50, automobile magnets, coils and parts, cheap. Want coils, Volt and Ammeters. Albert Onody, 336 Oak Street, Buffalo, N.Y.

BOYS ATTENTION! Owing to demand, we have added a wireless table with cabinet cover to our list of knocked down furniture. Price from \$1 up. Send for descriptive circular. Stevenson Mfg. Co., 459 Tehama St., San Francisco, Cal.

YOU MUST send stamped envelope for list of Wireless, Electrical, Mechanical goods. Carroll, Valley City, N.Dak.

CEMENT—Best for Experimenters, sure sticker. Formula 50c. M. Blain, Barre, Vt.

FOR SALE—Tested galena, 20c. per piece. Only silver accepted. Alvin Manternach, 17729 Windward Rd., Cleveland, Ohio.

THE POPULAR APRIL SPECIAL extended thru May. Specially selected Audion FREE with every order for the ultra-sensitive "PARAGON" Amplifying Short Wave Receiver at \$35. 15,000

meter loose couplers, \$11.50. Complete audion sets potentiometer equip, for damped and undamped signals, with "B" batteries and selected two filament bulb, \$12.95. Send stamp for new catalog of QUALITY apparatus. Arthur B. Church, Lamoni, Iowa.

SPECIAL—Oscilandion bulbs for \$4.75 each. Regenerative sets with detector \$50. Undamped sets \$40 complete. Let us know your needs and we will quote you. Radio Equipment Co., 104 Fifth Ave., New York. Cable address RECO, N.Y.

OBTAIN RESULTS with Stratton Apparatus: Tuner, \$6.50. Send 2c stamp for price list. Stratton Electric Company, 215 Federal Street, Greenfield, Mass.

LEUMITE—the new detector mineral, sensitive, staple. Send 25c. for generous guaranteed piece. Leumas Laboratories, 1261 Park Ave., New York.

ONLY \$21.75? Gee! Paid \$24 for mine! Where'd you get 'em? From POWELL, agent for 36 companies. Send him return postal for bargain prices on any radio instrument made. 216 Spruce, Takoma Park, Md.

NEVER BEFORE! Galena detector, extremely sensitive, next to permanent, holds adjustment for weeks, 39c. prepaid. Lenzie detectors, \$4.25. Kinderhook Electrical Agency, Kinderhook, N.Y.

WOOD PARTS for 4,000 M. coupler finished in beautiful polished mahogany, size 18x7x1 1/2 in. While they last, with blue prints, 98c. Include postage for three pounds. Louis E. Schwab, 3708 Brooklyn Ave., Cleveland, Ohio.

VACUUM DETECTOR CIRCUITS—for bulb and tubular types, damped and undamped waves. Very latest. Complete with full descriptions, 50c. No stamps. L. H. Reiner, Bexley, Ohio.

WIRELESS KITES—Manufacturers of kites of every description for every purpose. Do you want to hear from POZ? Write us, Dept. E., Frank G. Seyfang, 1465 Broadway, New York City.

BAER ELECTRIC CO., Van Wert, Ohio—Special this month: 8 V., 18 W., Bell Transformers, rings 10 bells continuously, best quality, fine finish; each, \$1.30. Satisfaction guaranteed; prompt; money refunded if not well pleased. Write for our price list of high quality supplies.

RADIO QUESTIONS answered free. Send 2c. stamp for reply. Hinz Electrical Co., 234 Palmer Ave., Syracuse, N.Y.

FOR SALE—Fifty Ford spark coils excellent for small sending station, \$1; without vibrator, 75c.; large static machine, \$5; also \$26 melophone horn, \$12. Write for list. Sidney Collisson, Keokuk, Iowa.

GET BETTER RESULTS by using a sterling silver detector spring, 25c. prepaid. Guaranteed to be sterling silver. Address, Malcolm Burton, 1157 Third Ave., Salt Lake City, Utah.

QUALITY AND LOW PRICE combined. Judge for yourself by some of these prices: Audion panels with knob-controlled rheostats and high voltage batteries, \$7. 5,000 meters cabinet set with combination perikon detector, \$15. "Reco" 2-slide tuner set, \$3.50. 12-inch 2-slide tuner, \$1.75. Send for literature. Lathe and specification work done. Radio Equipment Co., 179 East 115th St., New York City.

You benefit by mentioning "The Electrical Experimenter" when writing to advertisers.

MURDOCK
No.55

Real Radio

THE BEST
IN THE

**SENSIBLY
PRICED
SENSITIVE
RADIO
RECEIVERS**

**2000
OHM COMPLETE
DOUBLE SET
\$4⁰⁰**

**GOOD ENOUGH
FOR ANY STATION**

**3000
OHM COMPLETE
DOUBLE SET
\$5⁰⁰**

WHY PAY MORE?

Description

Patented "SOLID" construction with absolutely permanent adjustment. Hard rubber composition cases. Genuine copper coil windings. Special thin diaphragms. Nickel-plated split head band. 5 foot mercerized cord and special connection block.



WILL YOU TRY A SET?

Or will you simply read this advertisement and say, "It sounds well—but—"

There is no "BUT" in our GUARANTEE. We positively guarantee that BETTER 'PHONES *CAN-NOT* BE OBTAINED at these prices. We unconditionally guarantee your satisfaction.

GET A SET FOR TRIAL

Send us a money order for the price of the set you select. It will be shipped to you at once. Try the set thoroughly for TWO WEEKS. Then, if you are dissatisfied with it in ANY way, send it back and your money will be refunded immediately.

ORDER YOUR SET NOW

Prices on all other MURDOCK APPARATUS have been advanced. Circular 16, showing NEW LIST PRICES, will be sent on application.

WM. J. MURDOCK CO.

55 Carter Street, CHELSEA, MASS.

221 Second Street

San Francisco

LEARN BY DOING

FIVE minutes of actual practice properly directed is worth more to a man than years and years of book study. Indeed, Actual Practice is the only training of value, and graduates of New York Electrical School have proved themselves to be the only men that are fully qualified to satisfy EVERY demand of the Electrical Profession.

At this "Learn by Doing" School a man acquires the art of Electrical Drafting; the best business methods and experience in Electrical Contracting, together with the skill to install, operate and maintain all systems for producing, transmitting and using electricity. A school for Old and Young. Individual instruction.



Letters from Successful Men

"I have done well since leaving school and am now Superintendent of the light, telephone and steam heat company here."

"Ten months after I left you I was given charge of this station. I saved at least 3 years by taking your course instead of working up as an apprentice."

"I have sole charge of all motors, lights, electrical devices and appliances, and in being able to hold this position I give all credit to the New York Electrical School and your personal interest in me, which until lately I did not realize would be so wonderfully beneficial to me."

"We had no electrical experience before taking your course and just one year since leaving school are working side by side with men of from five to ten years' experience."

"Since graduating from your school, I have been able to handle successfully any problem that has come before me in my line of electrical work and I wish to express my feelings for the school and its methods of training."

New York the Center

We are located in the heart of New York City and you can see the advantage of that. New York is the heart of everything electrical—there are big plants nearby, electrical exhibitions, libraries and facilities for good, quick work in an atmosphere of industry.

A large number of our students come from other cities, from all over the United States. They realize the advantage of coming to New York to learn electricity. About 4,500 in all have gone out from our school into success. You can do the same. We believe that with us you can learn more thoroughly and more quickly than anywhere else because we give you practice. We teach you only what you use.

And Now

If you have an ambition to make a name for yourself in the electrical field you will want to join the New York Electrical School. It will be an advantage to you to start at once. Then you should hurry to send for our 64-page book which tells you all about the school, with pictures of our equipment and students at work, and a full description of the course. You need not hesitate to send for this book. It is FREE to everyone interested in electricity. It will not obligate you to send for it. Send the coupon or write us a letter. But write us now while you are thinking about the subject of electricity.

School open to visitors 9 A. M. to 9 P. M.



New York Electrical School,
29 W. 17th St., New York, N. Y.

Please send FREE and without obligation to me your 64-page book.

NAME

ADDRESS

NEW YORK ELECTRICAL SCHOOL
29 WEST 17TH ST.,
NEW YORK, N. Y.